



INSTALLATION INSTRUCTIONS

Accessory
ALL-SEASON FLOOR MATS

Application
2024 RIDGELINE
MODEL SERIES

Publications No.
VERSION 1
Issue Date
NOV 2023

GENERAL VIEW

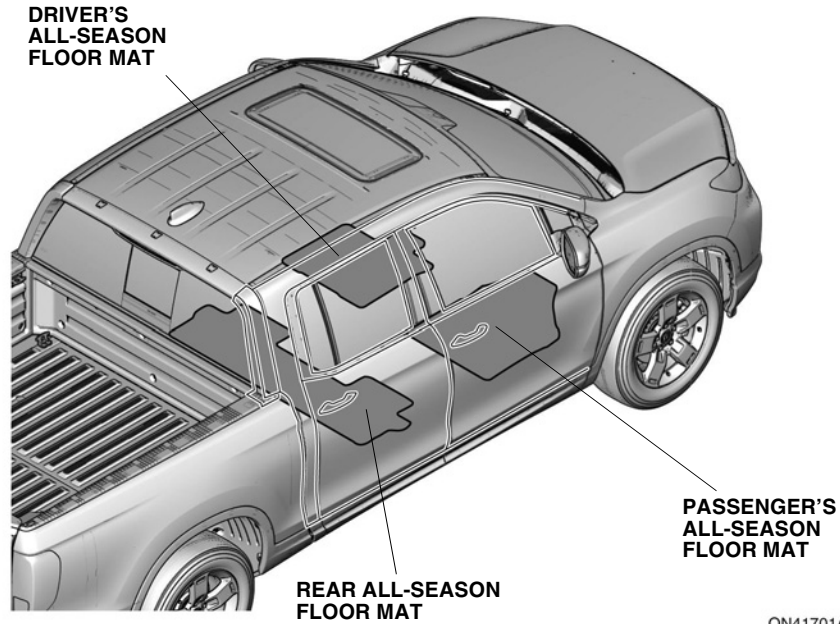

FOR YOUR SAFETY (Read carefully.)

Warning Symbols

Safety: Your safety, and the safety of others, is important. To help you make informed decisions about service procedures, we have provided safety messages where appropriate. Of course, it is not practical or possible to warn you about all the hazards associated with servicing a vehicle - you must use your own good judgment.

You will find important safety messages preceded by one of the following symbols:

*All symbols are not used in all installation instructions.

⚠ DANGER

You will be killed or seriously hurt if you do not follow the instructions.

⚠ WARNING

You can be killed or seriously hurt if you do not follow the instructions.

⚠ CAUTION

You can be hurt if you do not follow the instructions.

NOTICE

Gives advice to prevent damage to the product, vehicle, the environment or other property.

NOTE

Gives helpful information or instructions to be followed when installing this product.



Indicates a prohibited action.

Procedure and Location Icons

These icons indicate the work location and the worker's point of view.

*All icons are not used in all installation instructions.

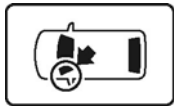

The location on the vehicle.

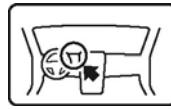

The location in the vehicle.
(Instrument panel.)



Wear eye protection.



Wear heavy gloves.



Use an assistant.



Place the part on a blanket.



Work perpendicular.



Remove any burrs.



Use touch-up paint and allow to dry.



Tighten to the specified torque.



Apply firm pressure while rolling, especially at the ends, to set the adhesive.



Press firmly.



Clean with isopropyl alcohol.



Return the original part to the customer.
(Do not reuse.)

Safety: General

- Be careful not to damage the vehicle or the parts.
- The illustrations may differ slightly from the actual accessory.

Safety: Accessory

- Always use the parts and tools specified in the installation instructions.
- When replacing the all-season floor mat, use the factory designed all-season floor mats compatible with the anchors.
- Do not put an additional floor mat on top of the anchored floor mat. It may slide forward and possibly interfere with the pedals.

PARTS LIST

All-season Floor Mats Kit
(P/N 08P17-T6Z-100B)
(P/N 08P17-T6Z-P00B)

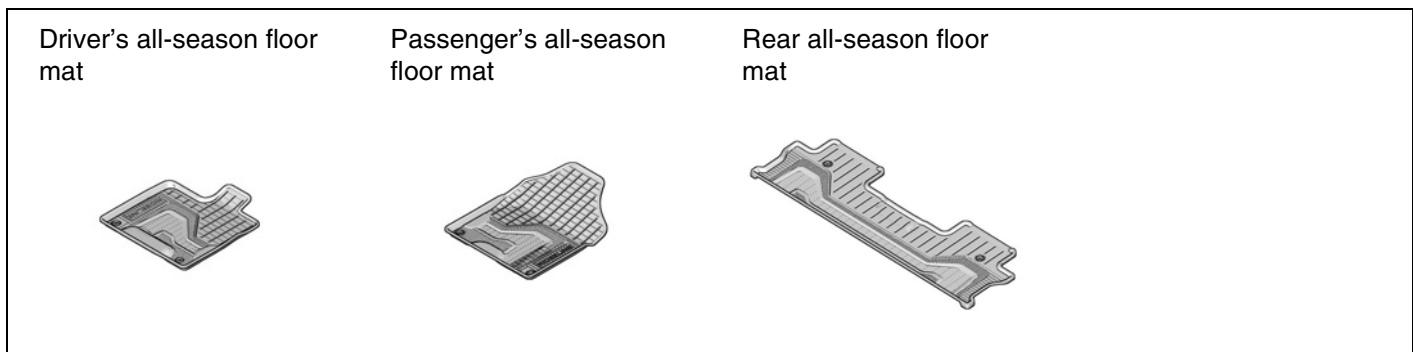

INSTALLATION

1. Remove the standard floor mats as described in the vehicle owner's manual.
2. Install the driver's all-season floor mat.

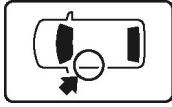

DRIVER'S ALL-SEASON FLOOR MAT

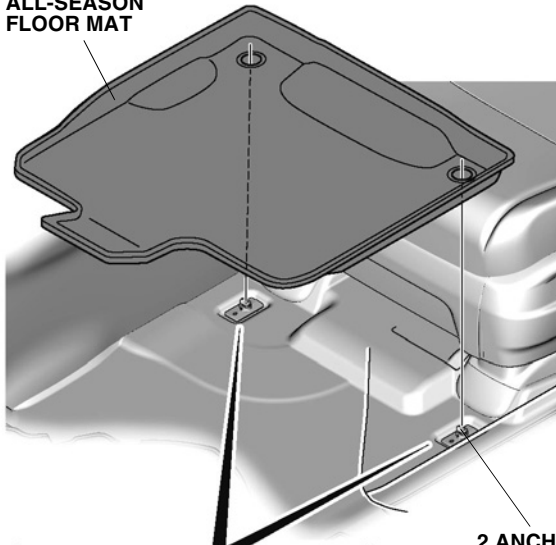

2 ANCHORS

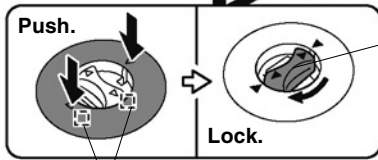

2 RETAINING TABS

KNOB (Turn.)

QK62602AN

3. Install the passenger's all-season floor mat.



PASSENGER'S ALL-SEASON FLOOR MAT

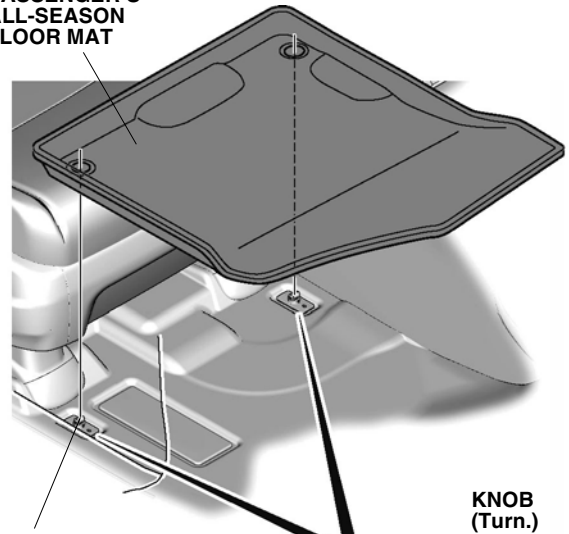

2 ANCHORS

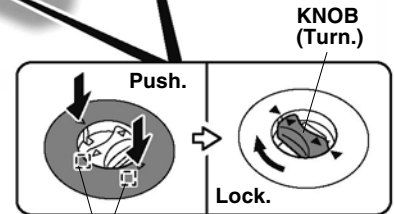

2 RETAINING TABS

KNOB (Turn.)

QK62603AN

4. Install the rear all-season floor mat.

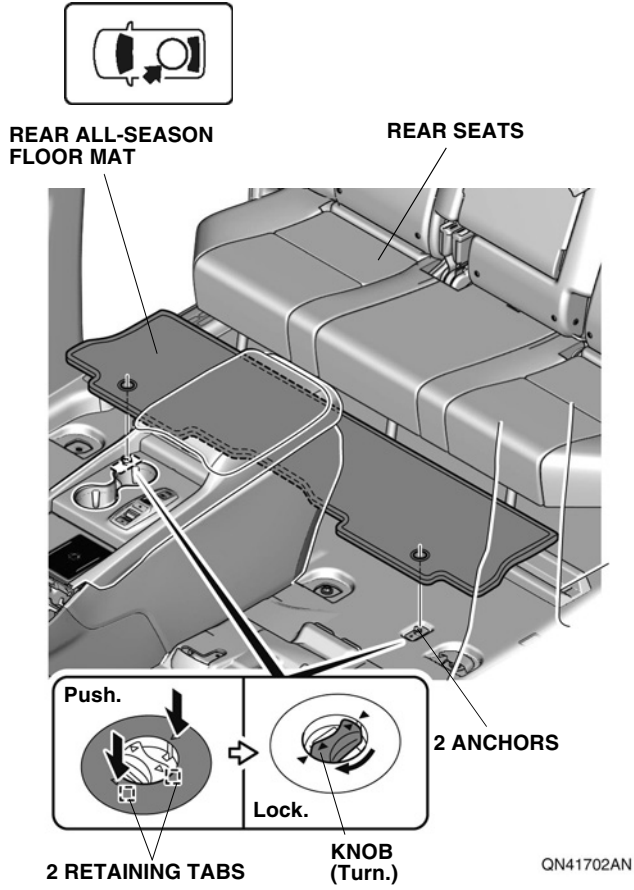

5. Check that all parts are installed properly.