



INSTALLATION INSTRUCTIONS

Accessory
DOOR HANDLE FILMS

Application
2021 RIDGELINE

Publications No.
VERSION 1
Issue Date
JAN 2021

GENERAL VIEW

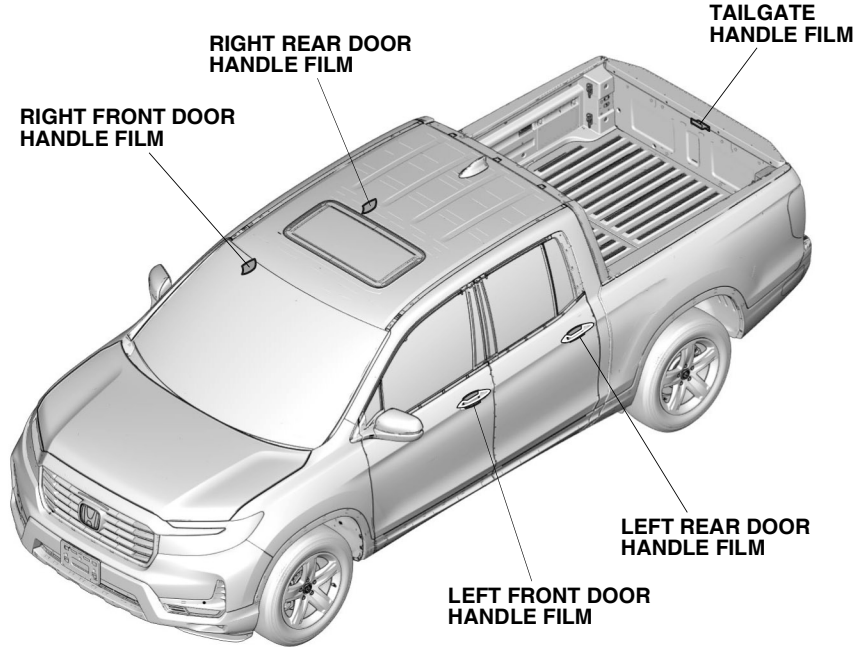

QK70801AN

FOR YOUR SAFETY (Read carefully.)

Warning Symbols

Safety: Your safety, and the safety of others, is important. To help you make informed decisions about service procedures, we have provided safety messages where appropriate. Of course, it is not practical or possible to warn you about all the hazards associated with servicing a vehicle - you must use your own good judgment.

You will find important safety messages preceded by one of following symbols:

*All symbols are not used in all installation instructions.

⚠ DANGER

You will be killed or seriously hurt if you do not follow the instructions.

⚠ WARNING

You can be killed or seriously hurt if you do not follow the instructions.

⚠ CAUTION

You can be hurt if you do not follow the instructions.

NOTICE

Gives advice to prevent damage to the product or vehicle or the environment.

NOTE

Gives helpful information or instructions to be followed when using the product.



Indicates a prohibited action

Procedure and Location Icons

These icons indicate the work location and the worker's point of view.

*All icons are not used in all installation instructions.

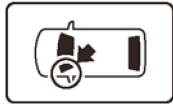

The location on the vehicle.

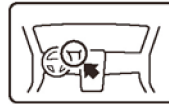

The location in the vehicle.
(instrument panel.)



Wear eye protection.



Wear heavy gloves.



Use an assistant.



Place the part on a blanket.



Work perpendicular.



Remove any burrs.



Use touch-up paint and allow to dry.



Tighten to the specified torque.



Apply firm pressure while rolling, especially at the ends, to set the adhesive.



Press firmly.



Clean with isopropyl alcohol.



Return the original part to the customer.
(Do not use.)

Safety: General

- Be careful not to damage the vehicle or the parts.
- The illustrations may differ slightly from the actual accessory.

Safety: Accessory

- Do not install the accessory on a dirty surface or in direct sunlight.
- Make sure the ambient air temperature is 60°F (15°C) or above when installing accessories that use a bonding material.
- Be careful to keep the accessories to dry. If you wet them, the tapes and the films can not provide their performance fully since the adhesive backings remains on the adhesive side.
- When applying adhesive material, make sure it is lined up properly before attaching. Once the adhesive material touches the surface, do not try to remove it. If you do, you could damage the part before the adhesive releases.
- Cover the around parts with the shop towel for not to wet.
- Use the 3M protective tape application solution with a spray bottle.
- Not to wash the vehicle for 24 hours to allow the adhesive to cure.

PARTS LIST

Door Handle Films Kit (P/N 08P48-T6Z-100A)

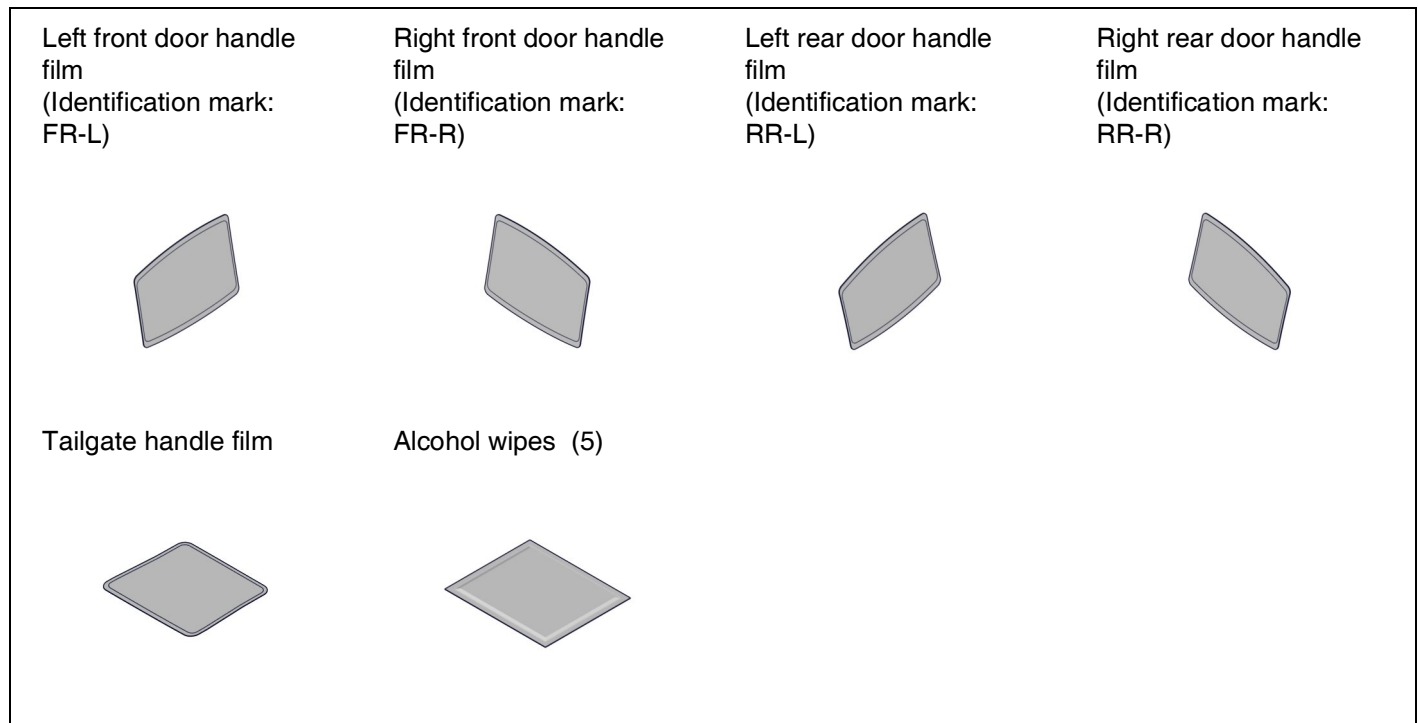

REQUIRED TOOLS AND SUPPLIES

- Shop towel
- 3M Protective tape application solution
- Spray bottle
- Gloves

The following tool is available through the Honda Tool and Equipment Program:

- Mini Soft Spreader/Applicator (T/N SBSA2302Y5PK)

INSTALLATION

1. Clean the attaching area.

NOTE

Allow to dry thoroughly.

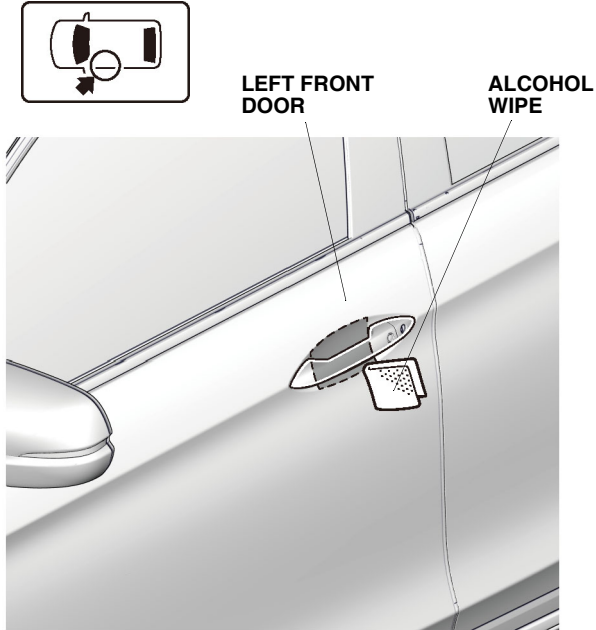

QH32104AN

2. Spray the left front door.

NOTE

Always wear gloves when working with 3M protective tape application solution.

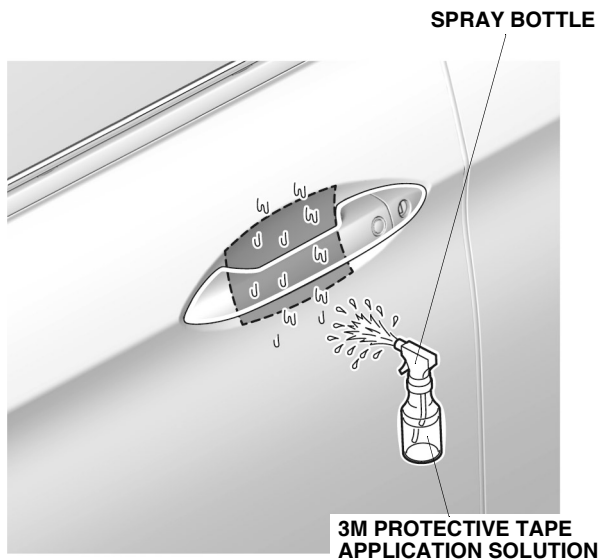

QJ71712AN

3. Remove the adhesive backing.

NOTE

- Make sure to check the identification mark before installation.
- Always wear gloves when working with 3M protective tape application solution.

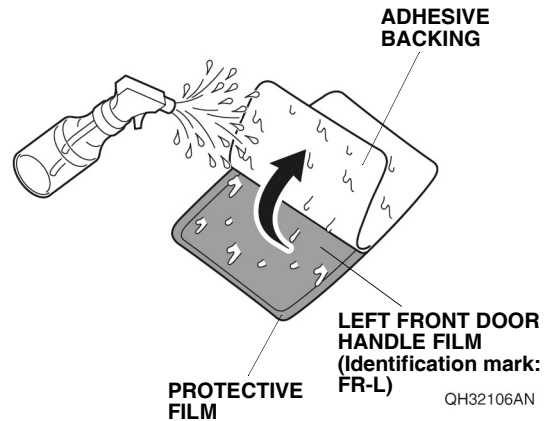

4. Spray the left front door handle film.

5. Line up the left front door handle film.

NOTE

Check the identification mark, arrow mark and installation position of the door handle film. Make sure to install the door handle film in the correct position and orientation.

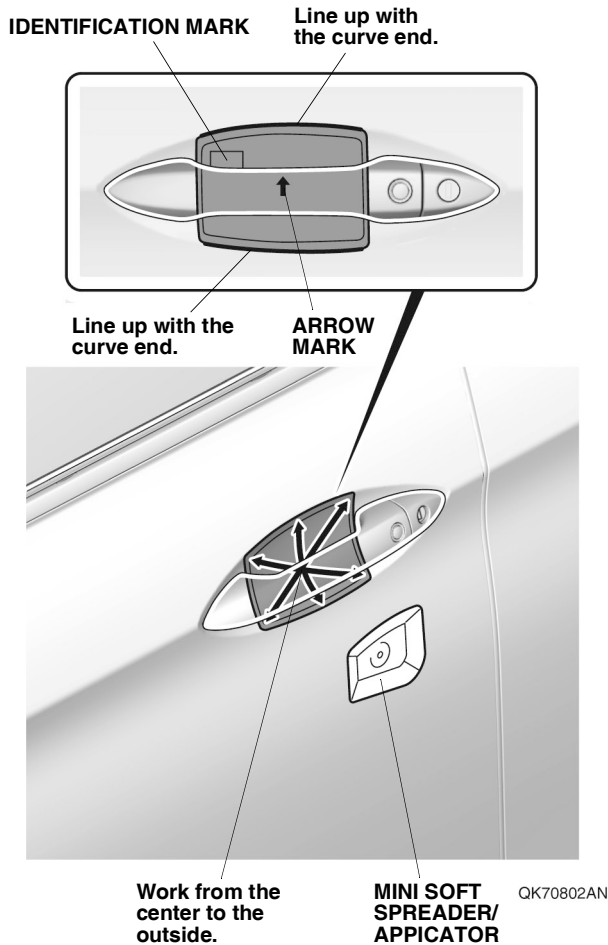

6. Secure the left front door handle film.

7. Remove the protective film.



8. Wipe off the 3M protective tape application solution.

NOTE

Allow to dry thoroughly.

9. Repeat steps 1 through 8 for the remaining door handle films except for the tailgate handle film.
10. Clean the attaching area.

NOTE

Allow to dry thoroughly.

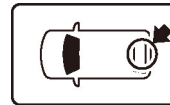

TAILGATE

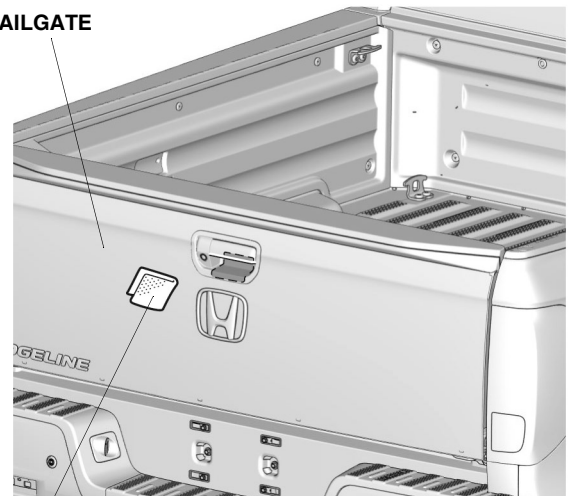

ALCOHOL WIPE

QK62605AN

11. Spray the tailgate.

NOTE

Always wear gloves when working with 3M protective tape application solution.



3M PROTECTIVE TAPE APPLICATION SOLUTION

QK62606AN

12. Remove the adhesive backing.

NOTE

Always wear gloves when working with 3M protective tape application solution.

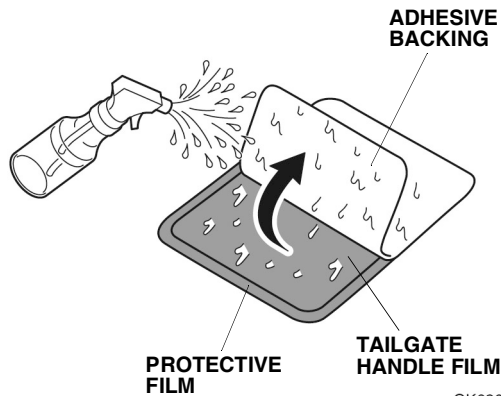

QK62607AN

13. Spray the tailgate handle film.

14. Line up the tailgate handle film.

NOTE

Check the arrow mark and installation position of the tailgate handle film. Make sure to install the tailgate handle film in the correct position and orientation.

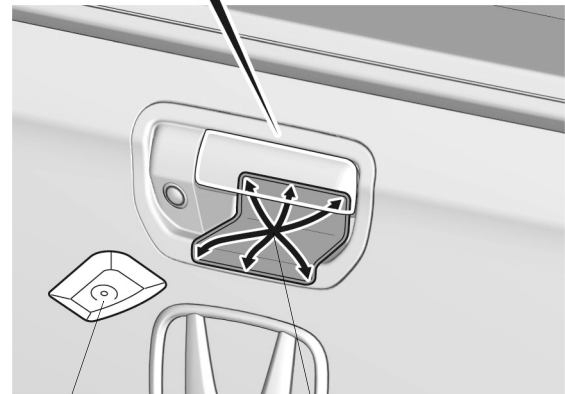
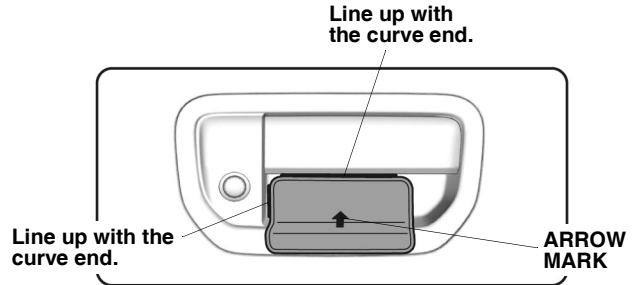

QK62608AN

15. Secure the tailgate handle film.

16. Remove the protective film.

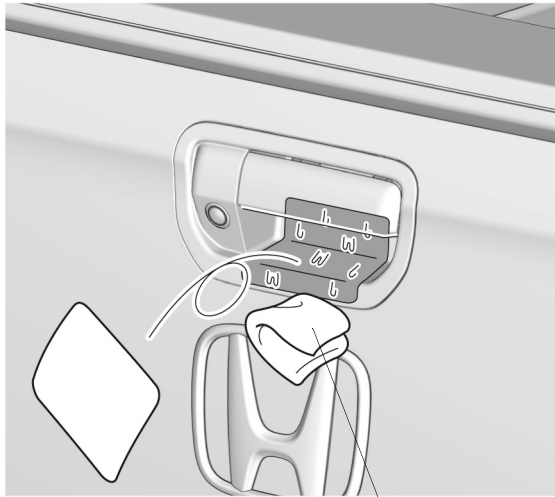

SHOP TOWEL QK62609AN

17. Wipe off the 3M protective tape application solution.

NOTE

Allow to dry thoroughly.

18. Check that all parts are installed properly.