



**INSTALLATION  
INSTRUCTIONS**

Accessory

**FOG LIGHTS**  
P/N 08V31-SJC-100B

Application

**2009 RIDGELINE**

Publications No.

**All 40320**

Issue Date

**AUG 2008**

**PARTS LIST**

Left fog light

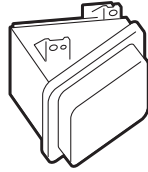

Right fog light

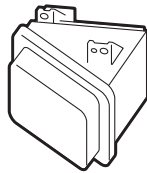

Fog light harness

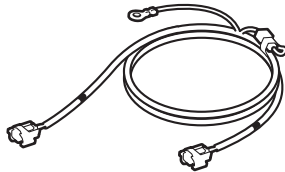

Switch harness

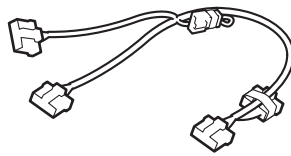

Switch

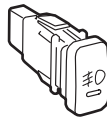

Relay

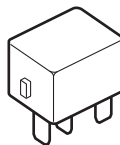

6 Tapping-screws, 5 x 16 mm



17 Wire ties

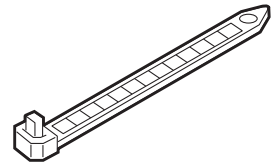

Fuse (20A)

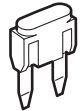

**TOOLS AND SUPPLIES REQUIRED**

Phillips screwdriver

Flat-tip screwdriver

Diagonal cutters

Ratchet

10 mm Socket

10 mm Combination wrench

Blanket

**Illustration of the Fog Lights Installed on the Vehicle**

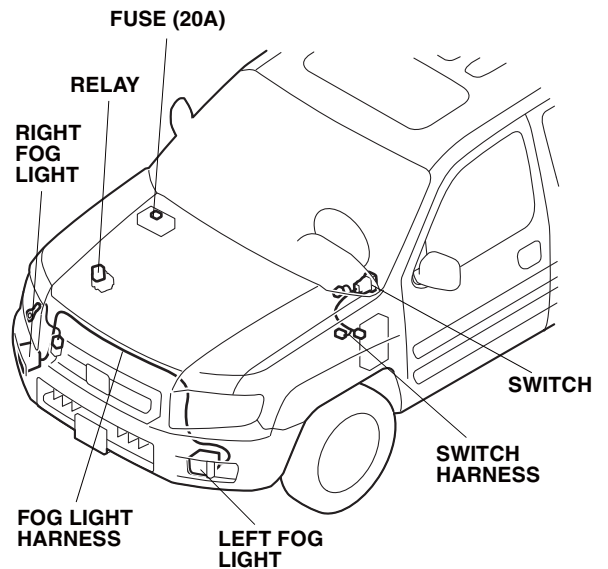

**INSTALLATION**

**Customer Information:** The information in this installation instruction is intended for use only by skilled technicians who have the proper tools, equipment, and training to correctly and safely add equipment to your vehicle. These procedures should not be attempted by “do-it-yourselfers.”

1. Make sure you have the anti-theft code for the audio and navigation system (if equipped).
2. Disconnect the negative cable from the battery.

**Removing the vehicle parts**

3. Remove the air intake duct and the front bulkhead cover (twelve clips).

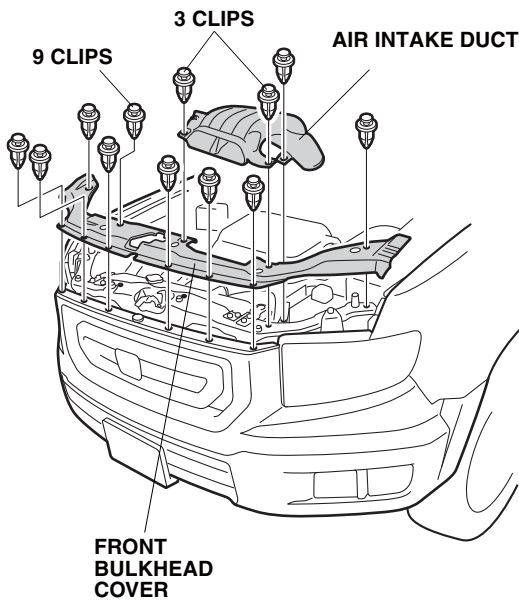

4. Remove the front bumper (one clip, four bolts, two short step bolts and four self-tapping screws). Have an assistant help you when removing the front bumper. Place the front bumper on a blanket after removal.

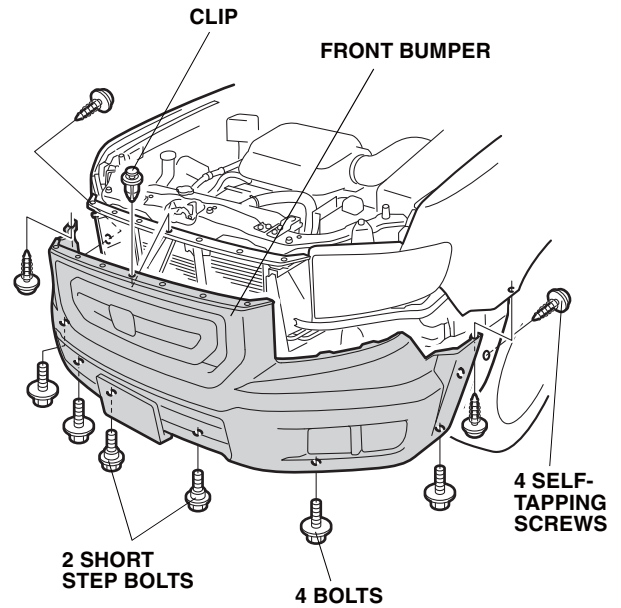

5. Remove the clip that fastens the washer reservoir tank.

