

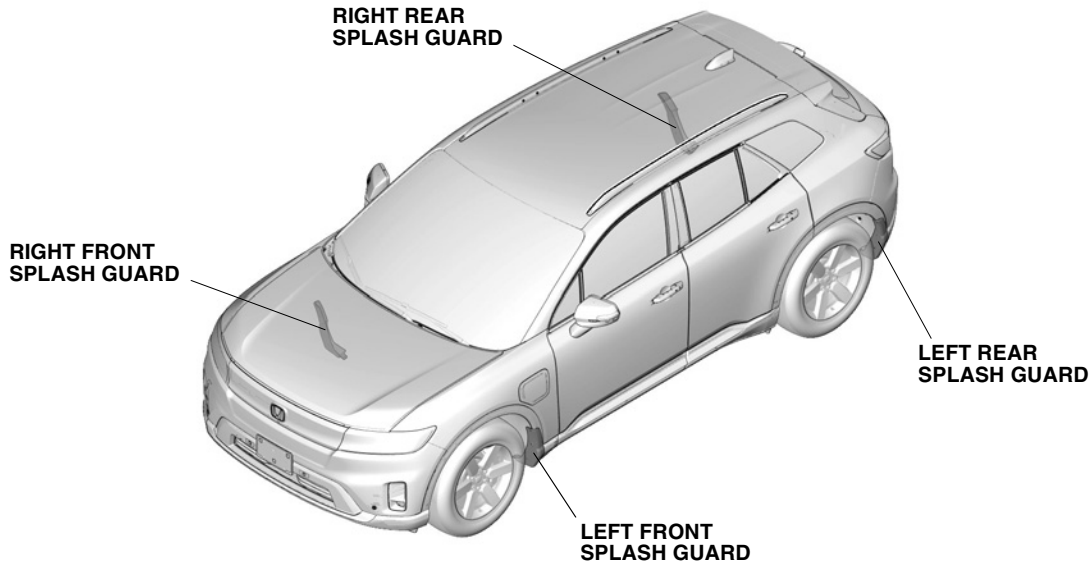

INSTALLATION INSTRUCTIONS

| Accessory | Application | Publications No. |
|---------------|----------------------------|------------------------|
| SPLASH GUARDS | 2024 PROLOGUE MODEL SERIES | VERSION 1 |
| | | Issue Date FEB 2024 |

GENERAL VIEW



QM00501AT

FOR YOUR SAFETY (Read carefully.)

Warning Symbols

Safety: Your safety, and the safety of others, is important. To help you make informed decisions about service procedures, we have provided safety messages where appropriate. Of course, it is not practical or possible to warn you about all the hazards associated with servicing a vehicle - you must use your own good judgment.

You will find important safety messages preceded by one of the following symbols:

*All symbols are not used in all installation instructions.

⚠ DANGER

You will be killed or seriously hurt if you do not follow the instructions.

⚠ WARNING

You can be killed or seriously hurt if you do not follow the instructions.

⚠ CAUTION

You can be hurt if you do not follow the instructions.

NOTICE

Gives advice to prevent damage to the product, vehicle, the environment or other property.

NOTE

Gives helpful information or instructions to be followed when installing this product.



Indicates a prohibited action.

Procedure and Location Icons

These icons indicate the work location and the worker's point of view.

*All icons are not used in all installation instructions.

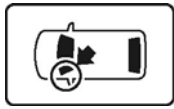

The location on the vehicle.

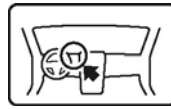

The location in the vehicle.
(Instrument panel.)



Wear eye protection.



Wear heavy gloves.



Use an assistant.



Place the part on a blanket.



Work perpendicular.



Remove any burrs.



Use touch-up paint and allow to dry.



Tighten to the specified torque.



Apply firm pressure while rolling, especially at the ends, to set the adhesive.



Press firmly.



Clean with isopropyl alcohol.



Return the original part to the customer.
(Do not reuse.)

Safety: General













- Observe all safety notes and precautions described in the service information, in addition to those described in this Installation Instruction. Be extremely careful for your safety and the safety of others.
- Be careful not to damage the vehicle or the parts.
- Be extremely careful to the handling of the retaining tabs and clips particularly.
- Note the locations of the parts before removing them so they can be properly installed in their original positions.
- The illustrations may differ slightly from the actual accessory.

Safety: Accessory

Always use the parts and tools specified in the installation instructions.

PARTS LIST

Splash Guard Kit (P/N 08P00-PS2-100)

| | | | |
|---|---|--|---|
| Left front splash guard | Right front splash guard | Left front bracket | Right front bracket |
|  |  |  |  |
| Left rear splash guard | Right rear splash guard | Left rear bracket | Right rear bracket |
|  |  |  |  |
| 4.2 x 35 mm Self-tapping screws (14) | 4.2 x 30 mm Self-tapping screws (2) | Spring nuts A (8) | Spring nuts B (2) |
|  |  |  |  |
| Washers (16) | | | |
|  | | | |

REQUIRED TOOLS AND SUPPLIES

- Pushpin
- Torque wrench
- Masking tape
- Drill
- Eye protection (face shield, safety goggles, etc.)
- T-15 TORX bit
- Felt-tip pen
- Ruler
- 7 mm Socket
- Ratchet
- File
- Utility knife
- 3 mm, 5 mm, 6 mm, 8 mm, and 10 mm Drill bits

INSTALLATION

1. Turn the steering wheel fully counterclockwise.

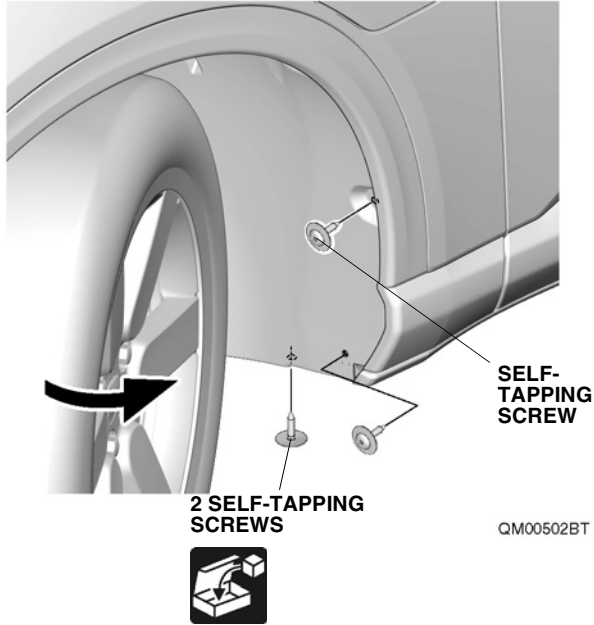

2. Remove the self-tapping screws.
3. Loosely install the left front splash guard.

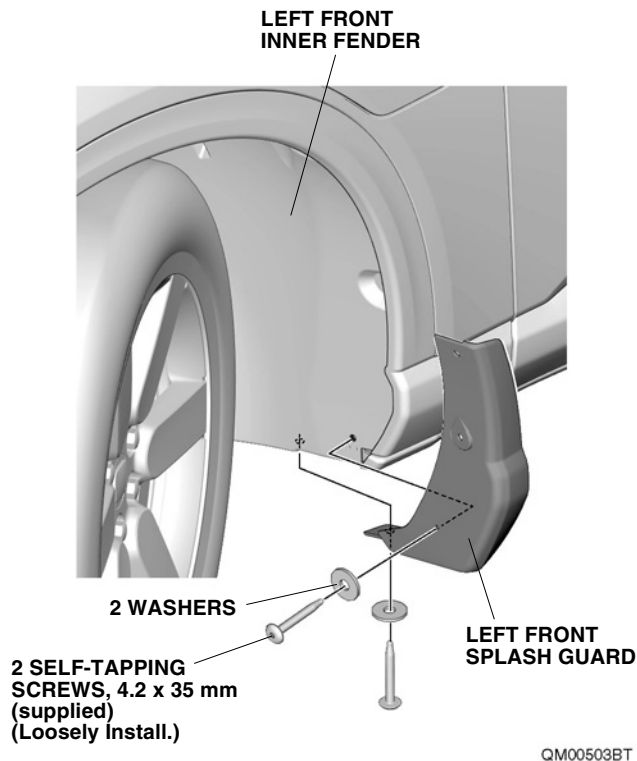

4. Mark the left front inner fender.

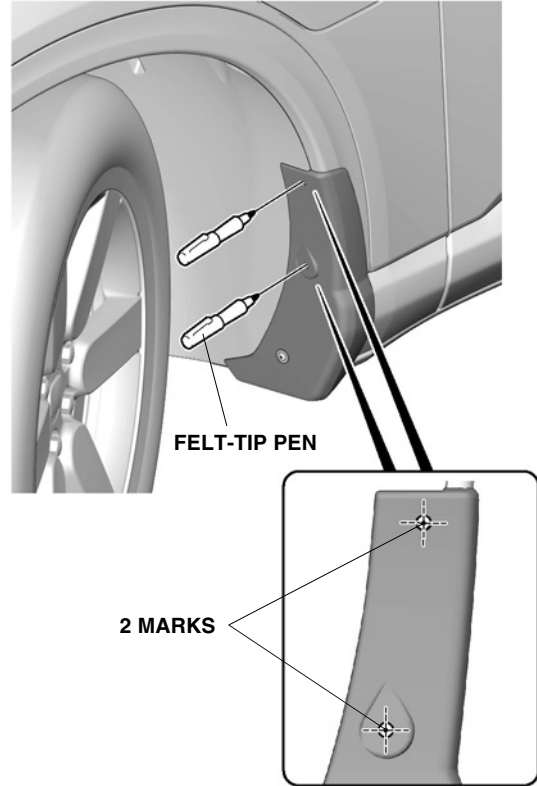

5. Remove the left front splash guard.

6. Pierce the left front inner fender.

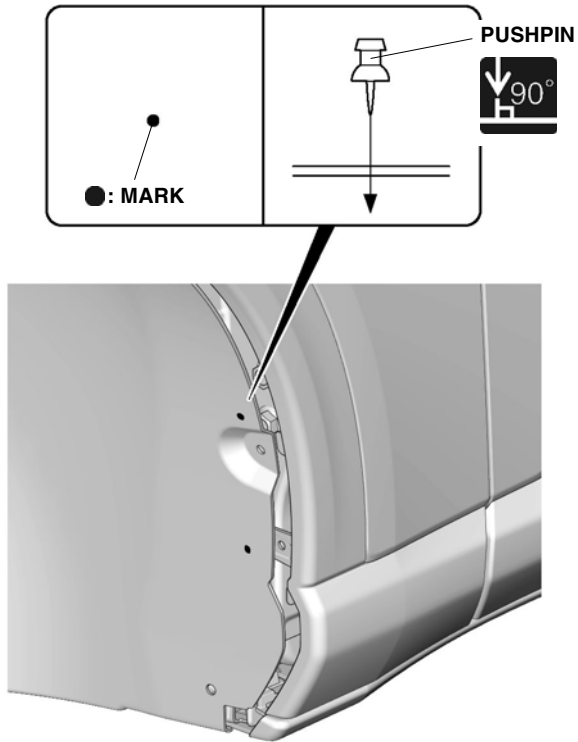

QM00523AT

7. Drill the left front inner fender.

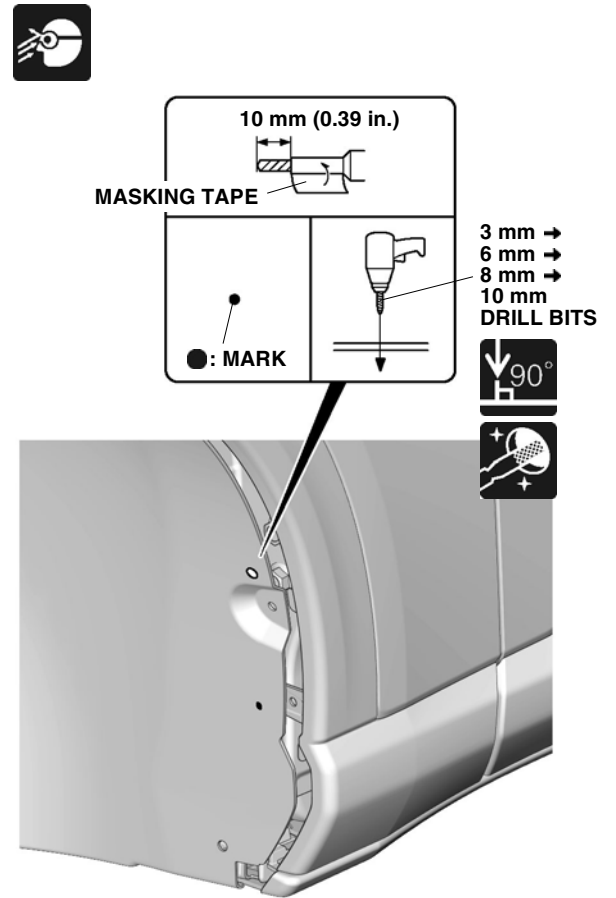

QM00505AT

8. Cut the left front inner fender.

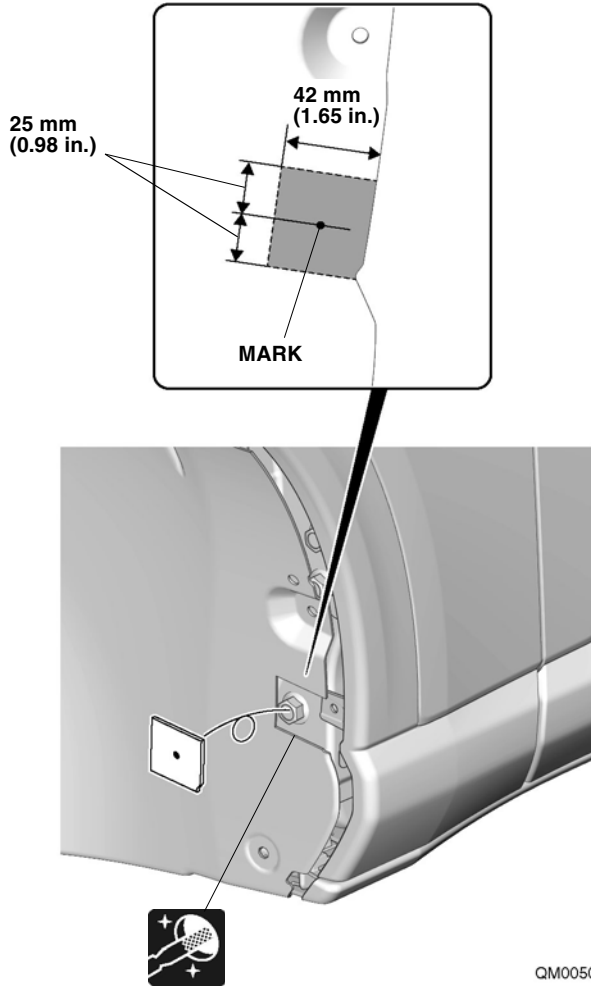

9. Install the spring nut A.

NOTE

Make sure to install the spring nut in the correct orientation.

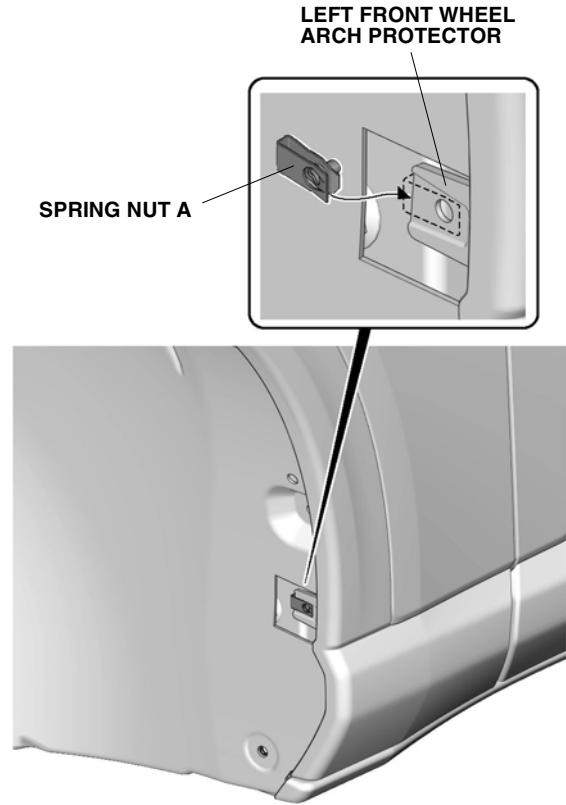

10. Install the spring nut A.

NOTE

Make sure to install the spring nut in the correct orientation.

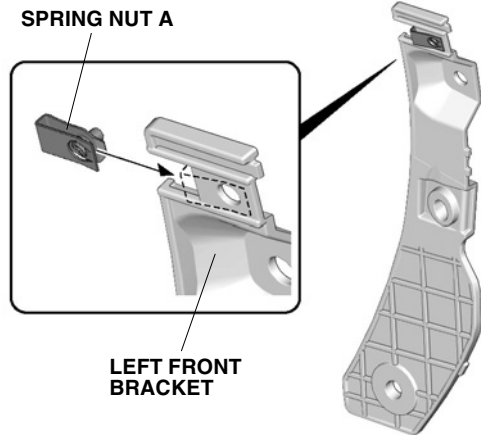

QM00508AT

11. Install the left front bracket.

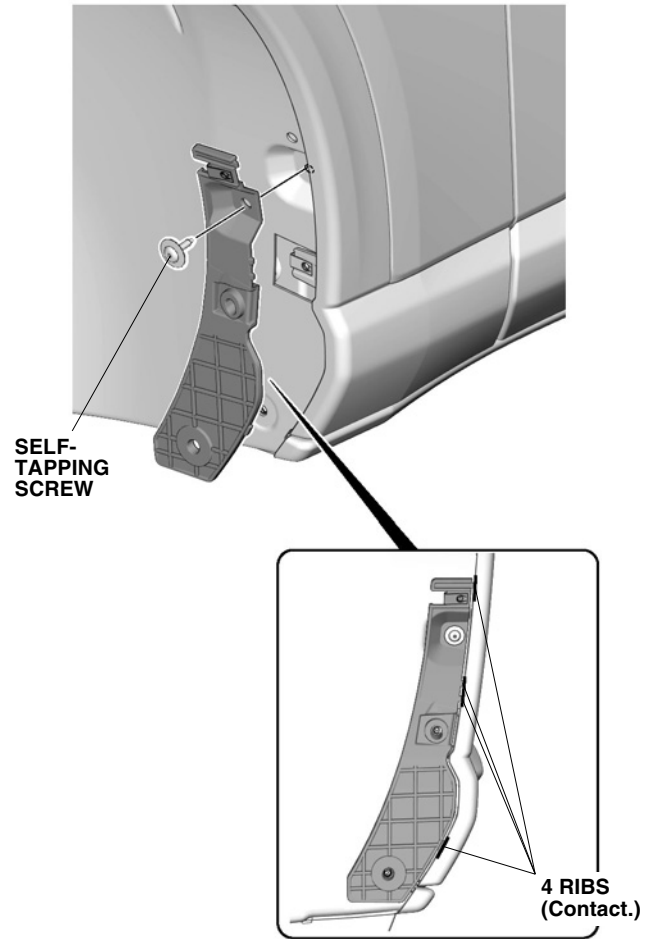

QM00509AT

12. Loosely Install the left front splash guard.

NOTICE

Install in the order shown.

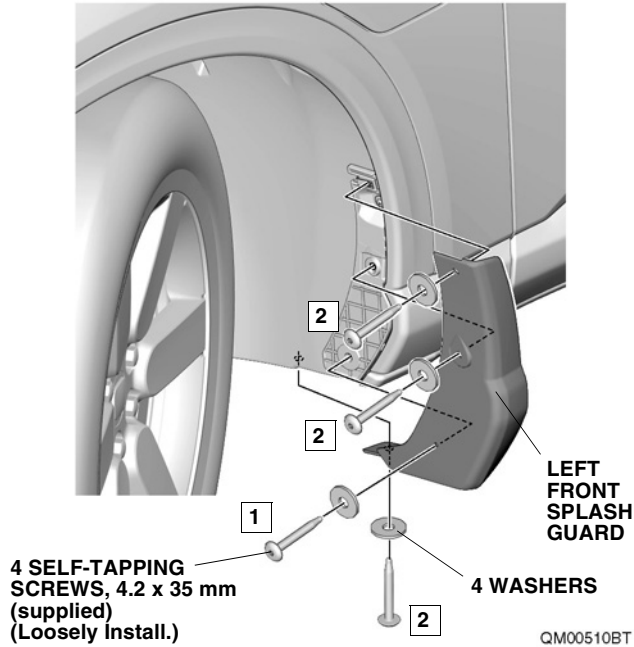

13. Secure the left front splash guard.

NOTICE

- Install in the order shown.
- Make sure that there is no gap between the splash guard and vehicle body. If there is a gap, loosen the self-tapping screws, hold the splash guard against the vehicle body, and retighten the screws.
- Make sure that the splash guard is properly installed.

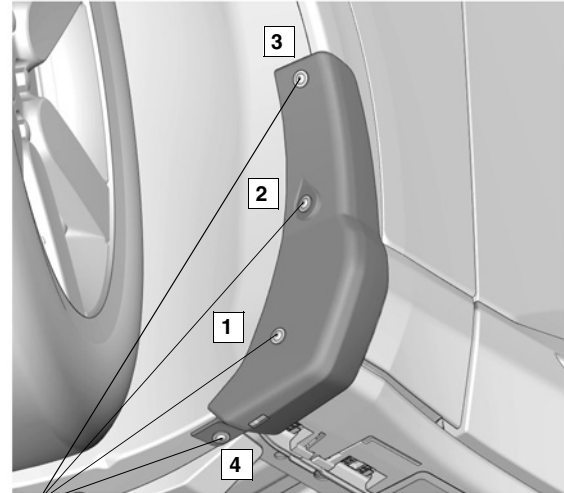

P lb-ft
2.2 lb-ft
(3 N·m)

14. Remove the left rear wheel.

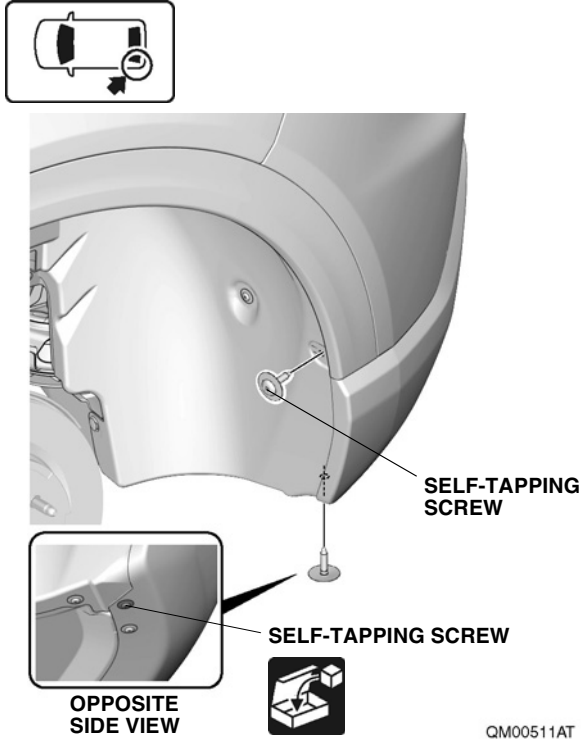

15. Remove the self-tapping screws.

16. Loosely Install the left rear splash guard.

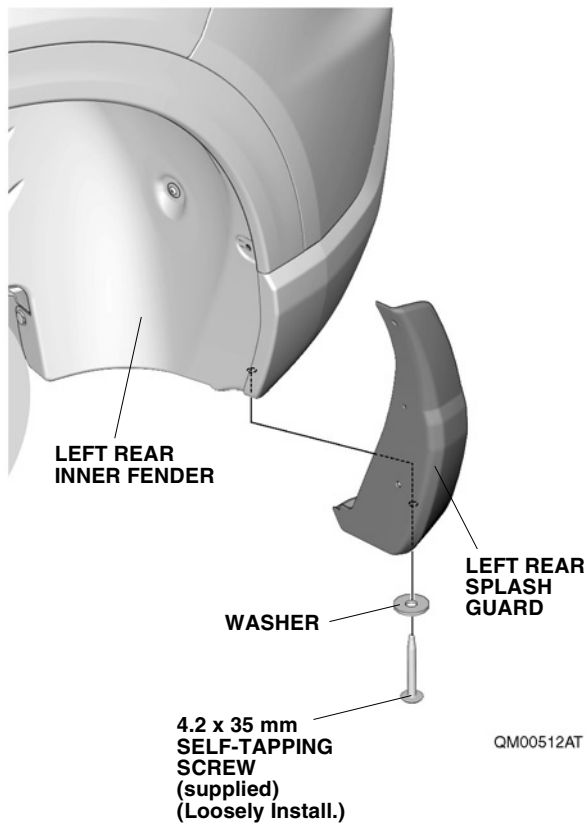

17. Mark the left rear inner fender.

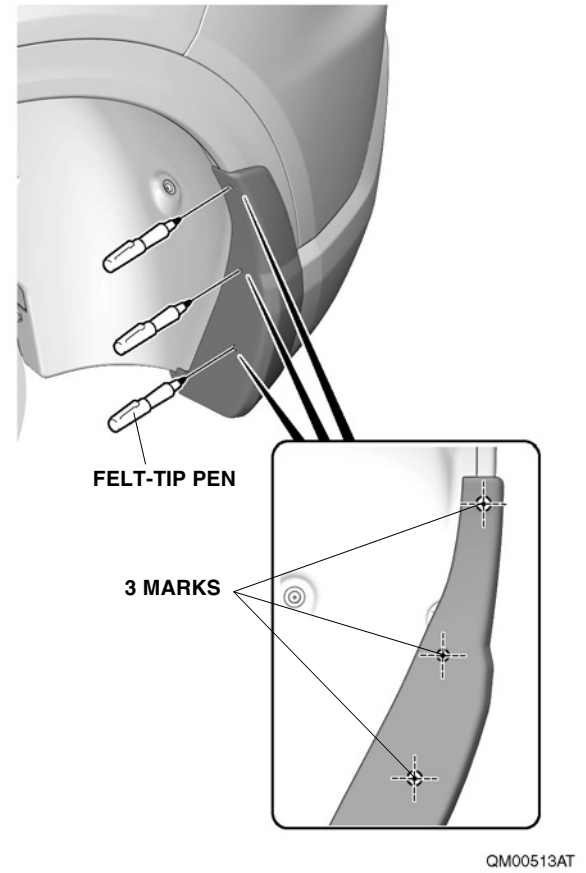

18. Remove the left rear splash guard.

19. Attach masking tape to protect the vehicle.

NOTE

Do not remove the masking tape until after the parts are installed.

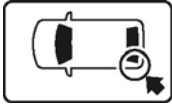

REAR BUMPER

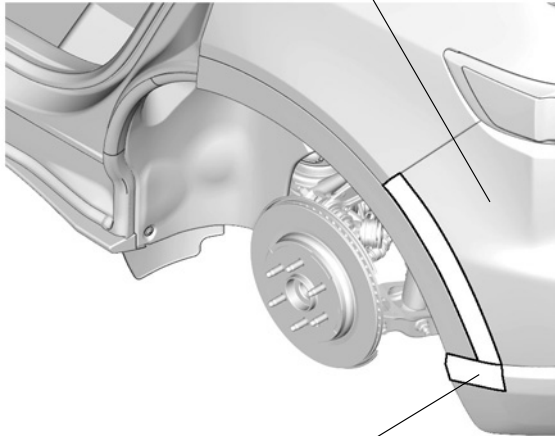

MASKING TAPE

QM00311BT

20. Remove the self-tapping screws.

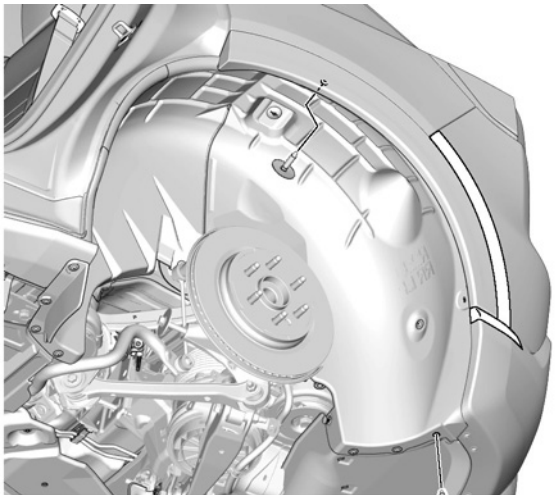
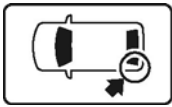

2 SELF-TAPPING SCREWS

QM00312CT

21. Release the left rear wheel arch protector.

NOTICE

- Be careful not to damage the clips.
- If you cannot release a clip using the 7 mm socket, use a trim tool.

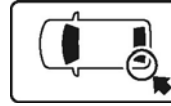

3 CLIPS
(Use a 7 mm
socket to
release the clips.)

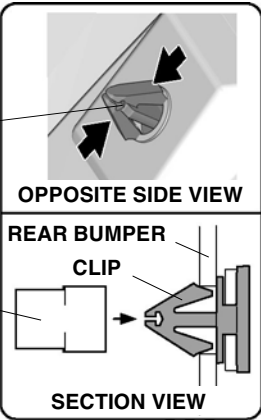

LEFT REAR
WHEEL ARCH
PROTECTOR

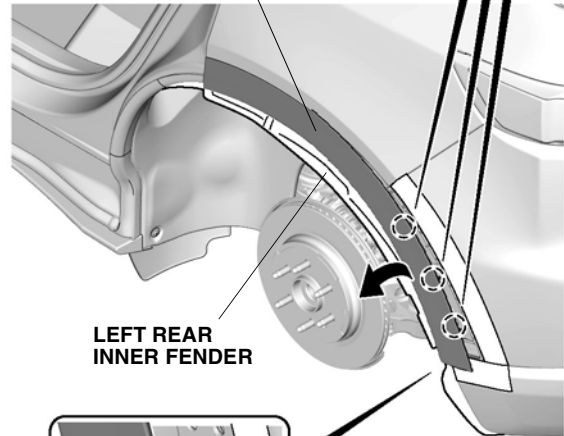

LEFT REAR
INNER FENDER

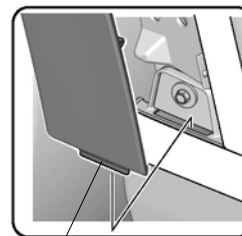

RETAINING TAB

QM00310CT

22. Pierce the left rear inner fender.

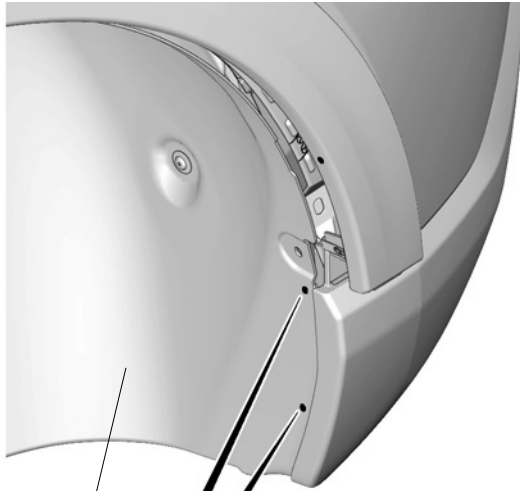
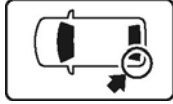

LEFT REAR
INNER FENDER

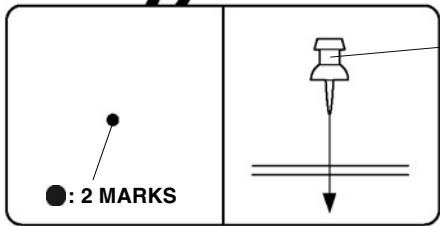

●: 2 MARKS

PUSHPIN



QM00525BT

23. Drill the left rear inner fender.

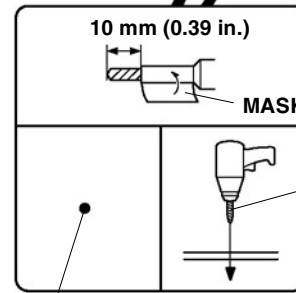
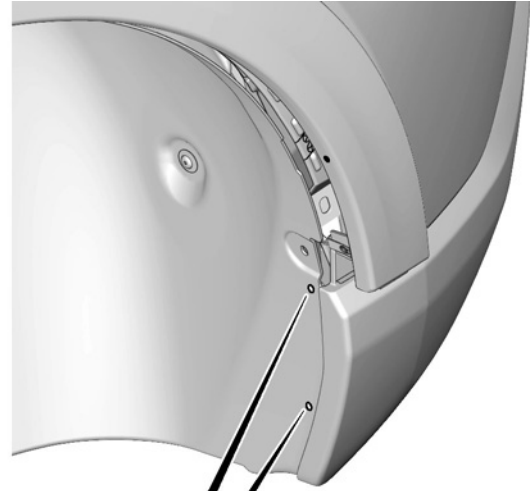

10 mm (0.39 in.)

MASKING TAPE

3 mm → 6 mm →
8 mm → 10 mm
DRILL BITS



●: 2 MARKS

QM00515BT

24. Pierce left rear wheel arch protector.

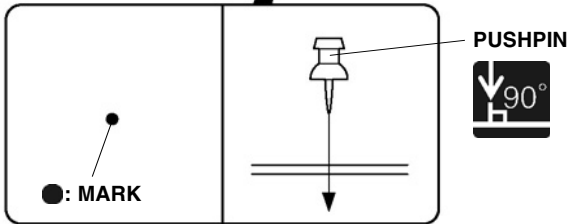
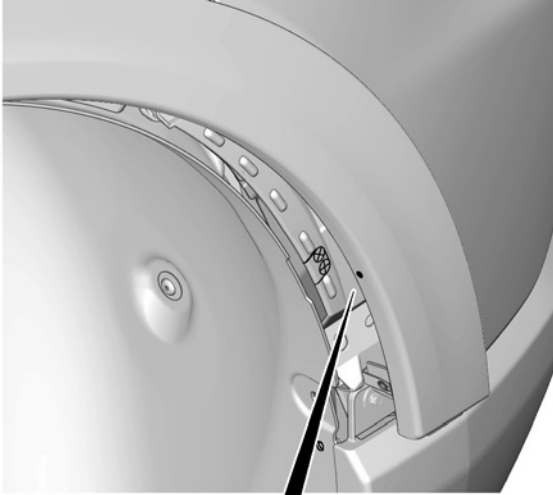

QM00526CT

25. Drill the left rear wheel arch protector.

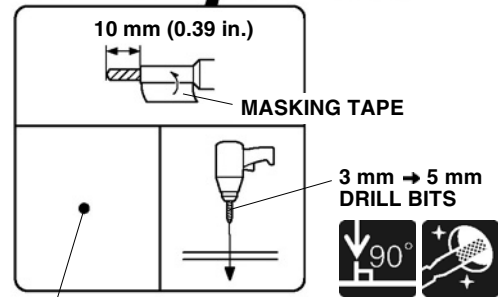
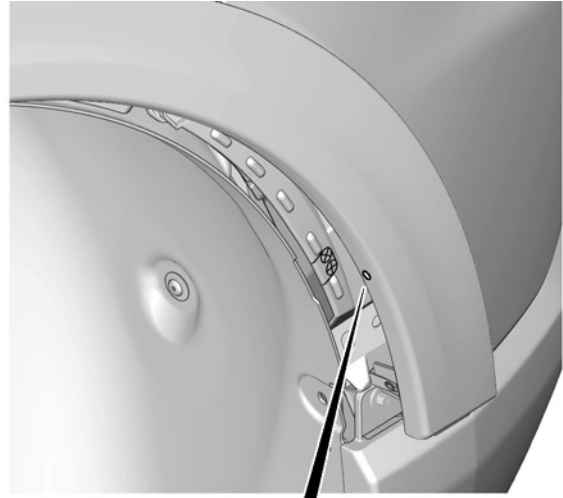

●: MARK

QM00514CT

26. Install the spring nut B.

NOTE

Make sure to install the spring nut in the correct orientation.

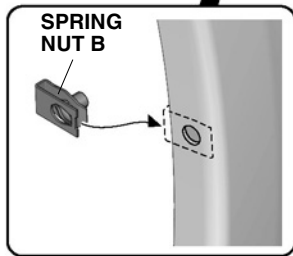
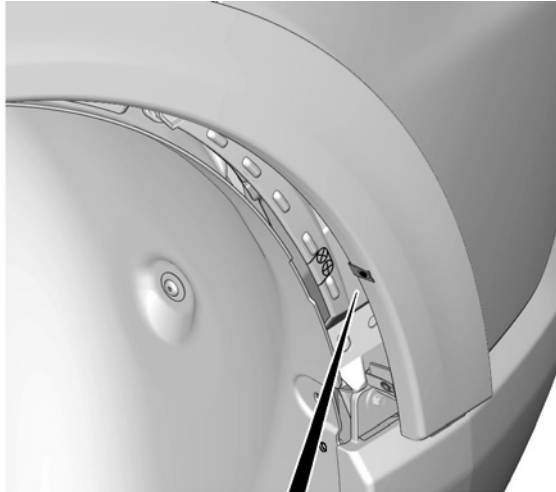

QM00519CT

27. Install the left rear wheel arch protector.

28. Install the spring nuts A.

NOTE

Make sure to install the spring nut in the correct orientation.

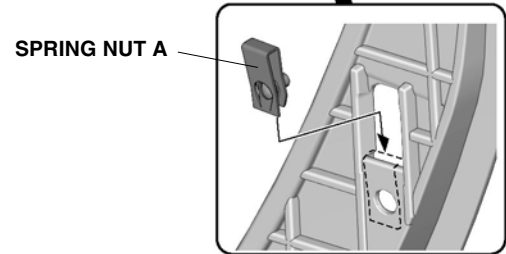
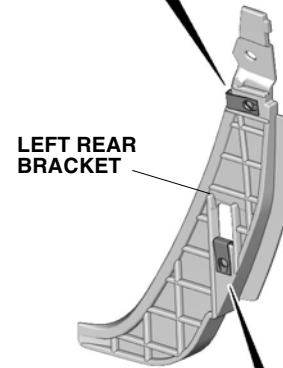
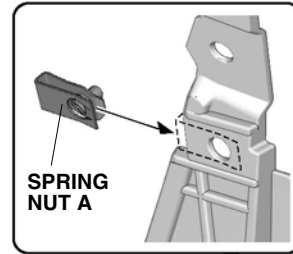

QM00520AT

29. Install the left rear bracket.

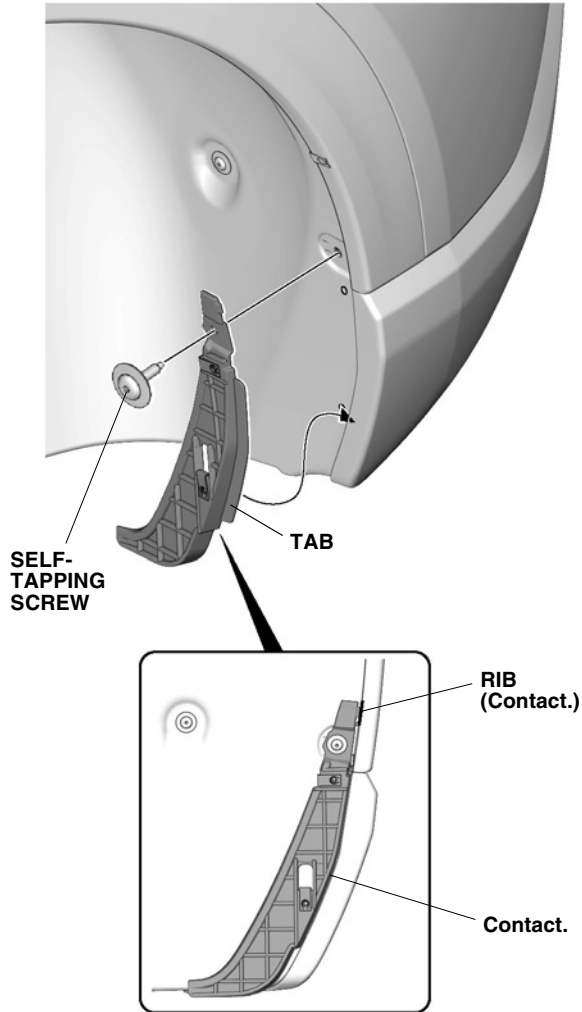

QM00521AT

30. Loosely Install the left rear splash guard.

NOTICE

- Install in the order shown.
- Make sure to install the self-tapping screws in the correct position.

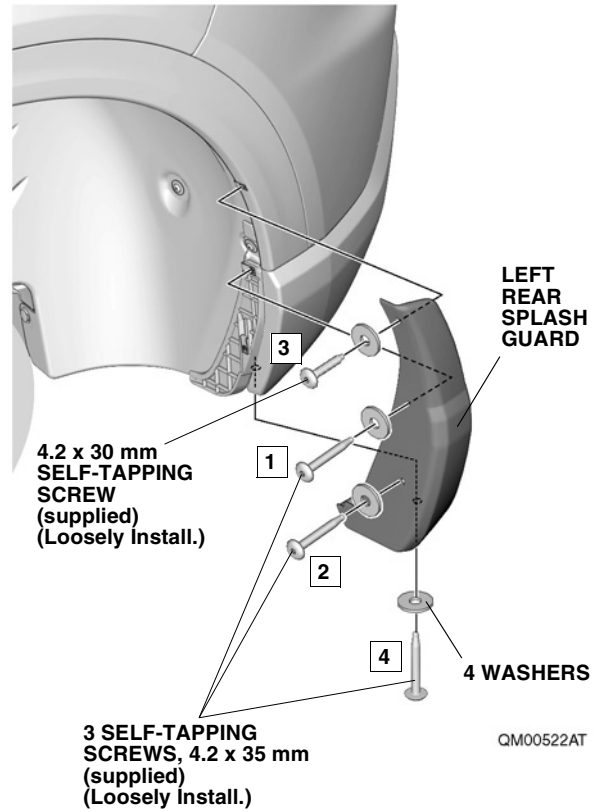

31. Secure the left rear splash guard.

NOTICE

- Install in the order shown.
- Make sure that there is no gap between the splash guard and vehicle body. If there is a gap, loosen the self-tapping screws, hold the splash guard against the vehicle body, and retighten the screws.
- Make sure that the splash guard is properly installed.

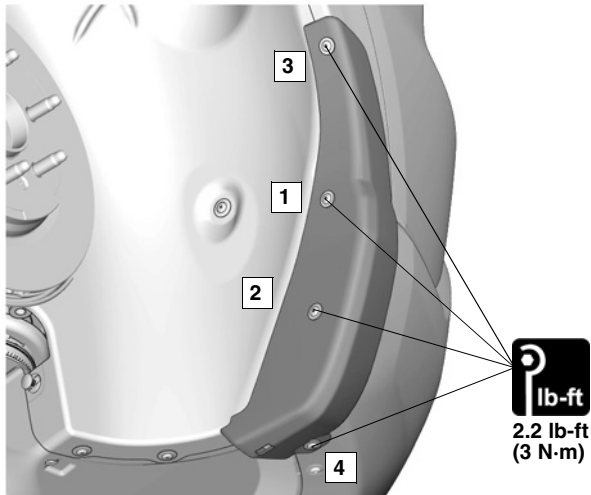

QM00527AT

32. Turn the steering wheel fully clockwise, and repeat the same procedures on the other side.

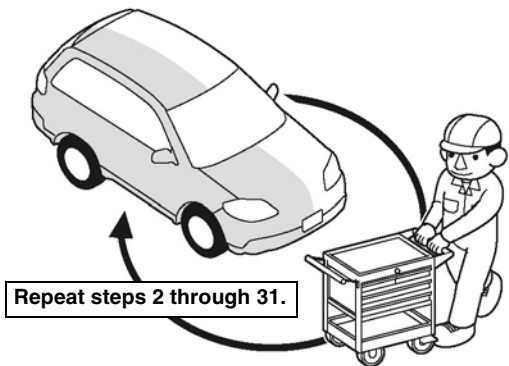

Q9D1014AM

33. Check that all parts are installed properly.
34. Install all removed parts.