

PROTECTION FILMS	2026 Prelude MODEL SERIES	Publications No. VERSION 1
------------------	------------------------------	-------------------------------

GENERAL VIEW

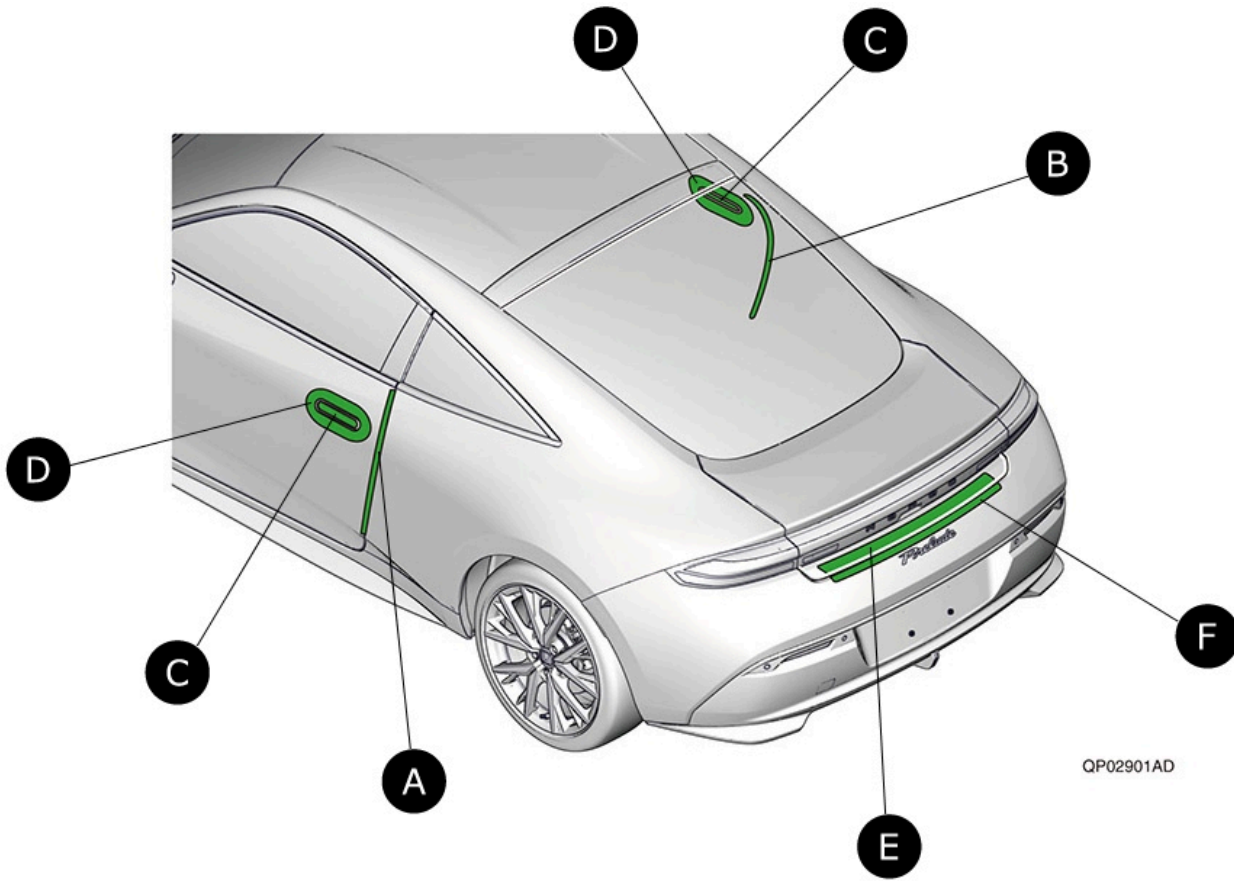

QP02901AD

A	LEFT DOOR EDGE FILM
B	RIGHT DOOR EDGE FILM
C	DOOR HANDLE FILM A
D	DOOR HANDLE FILM B
E	REAR BUMPER APPLIQUE A
F	REAR BUMPER APPLIQUE B

FOR YOUR SAFETY (Read carefully.)

Warning Symbols

Safety: Your safety, and the safety of others, is important. To help you make informed decisions about service procedures, we have provided safety messages where appropriate. Of course, it is not practical or possible to warn you about all the hazards associated with servicing a vehicle - you must use your own good judgment.

You will find important safety messages preceded by one of the following symbols:

*All symbols are not used in all installation instructions.

DANGER

You will be killed or seriously hurt if you do not follow the instructions.

WARNING

You can be killed or seriously hurt if you do not follow the instructions.

CAUTION

You can be hurt if you do not follow the instructions.

NOTICE

Gives advice to prevent damage to the product, vehicle, the environment or other property.

NOTE

Gives helpful information or instructions to be followed when installing this product.











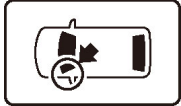
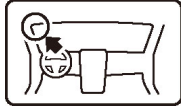







Indicates a prohibited action.





Procedure and Location Icons

These icons indicate the work location and the worker's point of view.

*All icons are not used in all installation instructions.

	The location on the vehicle.		The location in the vehicle. (Instrument panel.)
	Wear eye protection.		Wear heavy gloves.
	Work by two or more people.		Place the part on a blanket.
	Mark with felt-tip pen.		Mark with pushpin. (Pierce through.)
	Mark with center punch.		Remove any burrs.
	Use touch-up paint and allow to dry.		Wrap the masking tape around the flat-tip screwdriver.
	Return the original part to the customer. (Do not reuse.)		Apply firm pressure while rolling, especially at the ends, to set the adhesive.
	Press firmly.		Tighten to the specified torque.
	Work perpendicularly.		Clean with isopropyl alcohol.

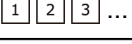
These icons indicate the name of part or location (also contain other instructions).

 ...	Name of part or location, etc.
 ...	Action or work instruction
 ...	Order of work
 ...	Position of clip
 ...	Position of retaining tab
(x 2) (x 3) (x 4) ...	Quantity

Safety: General

CAUTION

Observe all safety notes and precautions described in the service information, in addition to those described in this Installation Instruction. Be extremely careful for your safety and the safety of others.

NOTICE

- Always use the parts and tools specified in the installation instructions.
- Be careful not to damage the vehicle or the parts.

NOTE

The illustrations may differ slightly from the actual accessory.

Safety: Accessory

CAUTION







Always wear gloves when working with 3M Protective tape application solution.

NOTICE

- Do not install the accessory on a dirty surface or in direct sunlight.
- Make sure the ambient air temperature is 60 °F (15 °C) or above when installing accessories that use adhesive material.
- When applying adhesive material, make sure it is lined up properly before attaching. Once the adhesive material touches the surface, do not try to remove it. If you do, you could damage the part.
- Cover nearby parts with a shop towel to prevent getting them wet.
- Use the 3M protective tape application solution with a spray bottle.
- Do not wash the vehicle for 24 hours to allow the adhesive to cure.

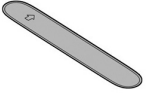
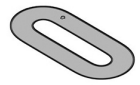
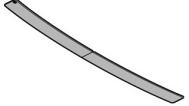
PARTS LIST

Protection Films Kit (P/N 08P48-36W-100)

Parts	Parts name	QTY	Remarks
	Left door edge film (identification mark: 36W-L)	1	
	Right door edge film (identification mark: 36W-R)	1	
	Door handle film A	2	
	Door handle film B	2	
	Rear bumper applique A	1	
	Rear bumper applique B	1	
	Alcohol wipe	8	
	Applicator	1	

REQUIRED TOOLS AND SUPPLIES

- Shop towel
- Gloves
- Masking tape
- Felt-tip pen
- 3M Protective tape application solution

INSTALLATION

Installing the Door Edge Films

1 Clean the attaching area.

NOTE

Allow to dry thoroughly.

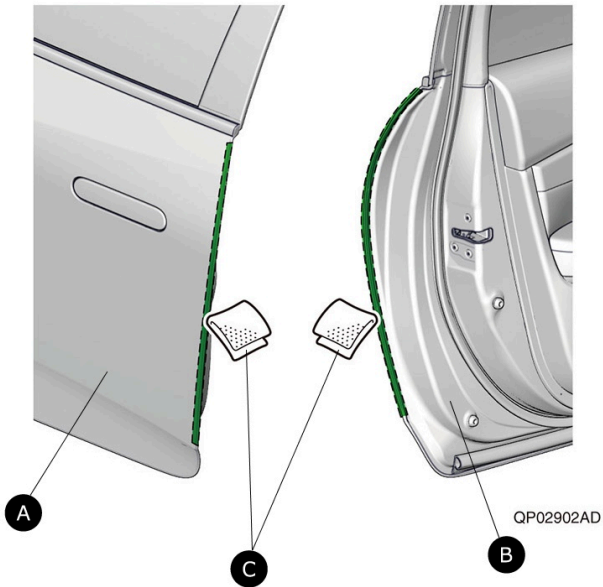
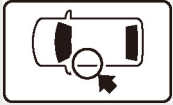

A	LEFT DOOR (outside)
B	LEFT DOOR (inside)
C	ALCOHOL WIPE

2 Spray the left door.

NOTE

Spray the outer surface of the door only.

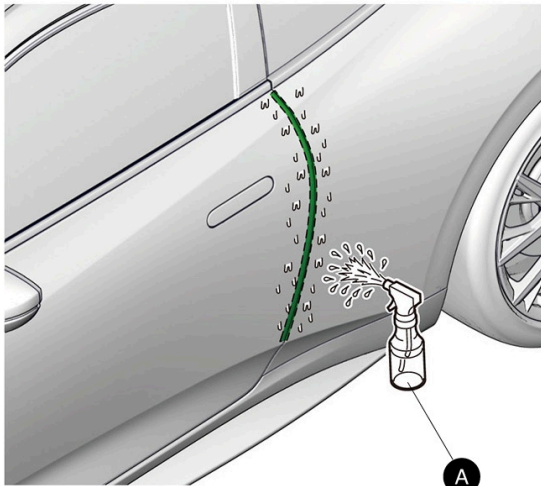

QP02903AD

A 3M PROTECTIVE TAPE APPLI-
CATION SOLUTION

3 Attach the left door edge film.

NOTE

Check the identification mark and the installation position of the door edge film.

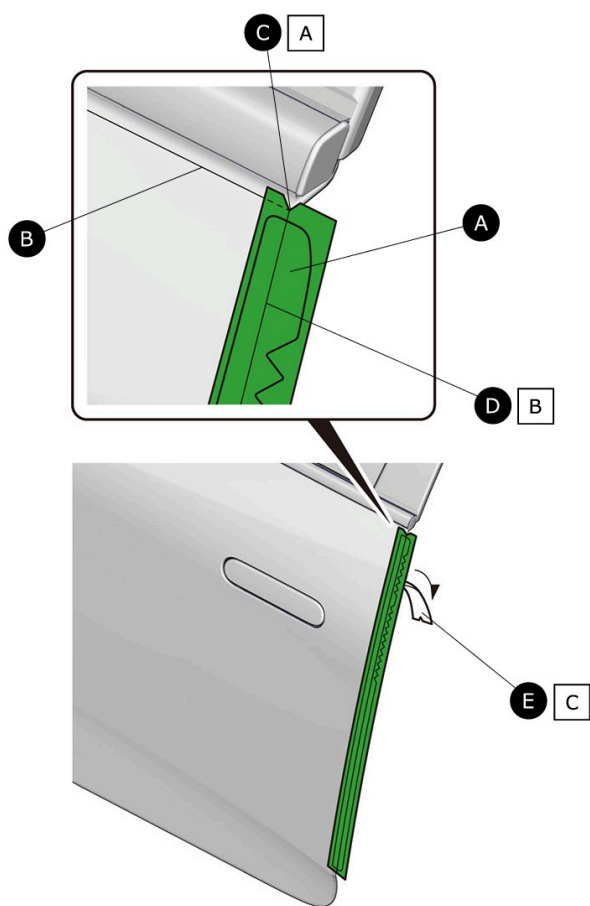
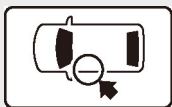

A	LEFT DOOR EDGE FILM (identification mark: 36W-L)
B	CHARACTER LINE
C	V-NOTCH
D	MARK
E	ADHESIVE BACKING
A	Line up with the bottom of the character line.
B	Line up with the edge of the left door.
C	Remove.

QP02904BD

4 Secure the left door edge film.

NOTE

- Work in one direction only.
- Make sure that there are no air bubbles.

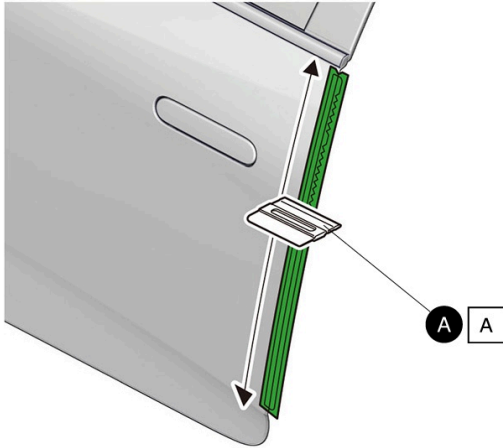

QP02905CD

A	APPLICATOR
A	Use the felt side.

5 Remove the protective film.

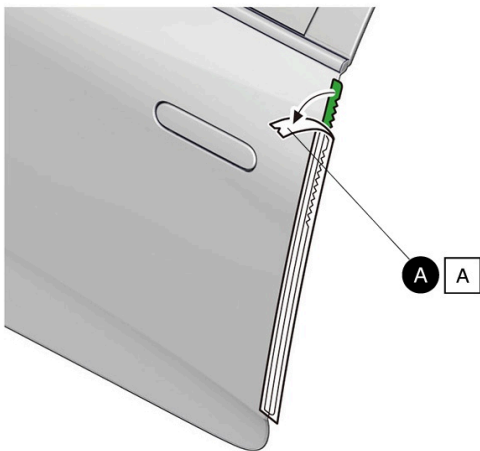

QP02906BD

A	PROTECTIVE FILM
A	Remove.

6 Secure the left door edge film.

NOTE

- Do not trim or damage the seam sealant.
- Make sure to prevent air from entering.

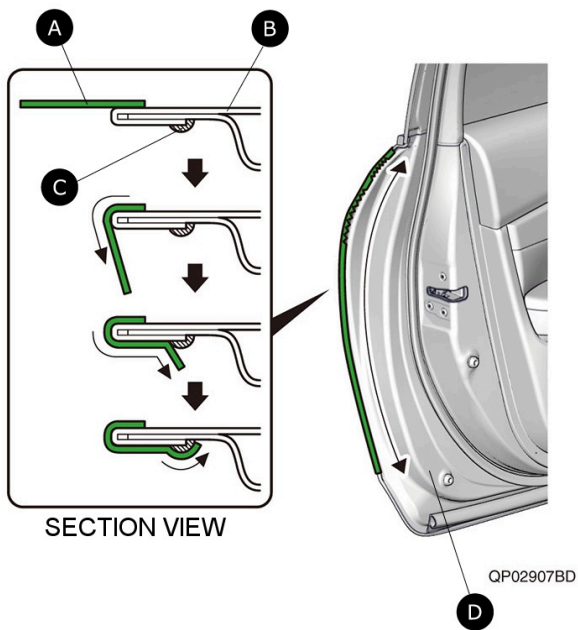
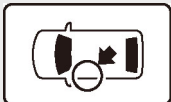

A	LEFT DOOR EDGE FILM
B	LEFT DOOR
C	SEAM SEALANT
D	LEFT DOOR (inside)

7 Wipe off the 3M protective tape application solution.

NOTE

Allow to dry thoroughly.



A LEFT DOOR (outside)

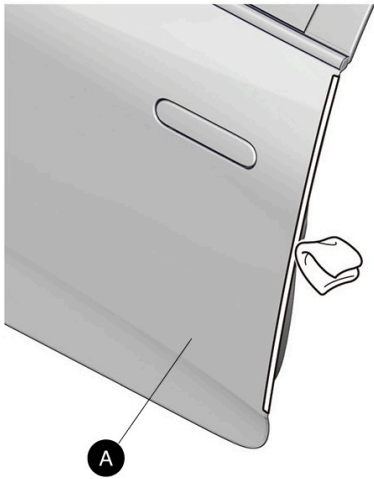

QP02908AD

8 Repeat steps 1 through 7 on the other side.

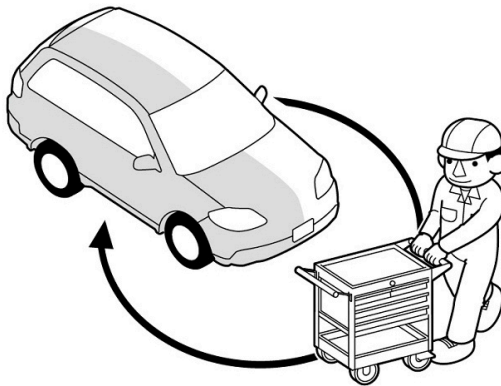

Q9D1014AM

Installing the Door Handle Films

9 Clean the attaching area.

 **NOTE**

Allow to dry thoroughly.



A ALCOHOL WIPE

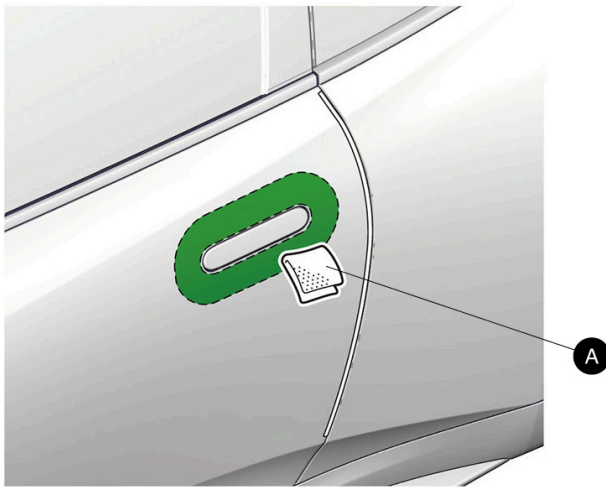

QP02915BD

10 Spray the left door.

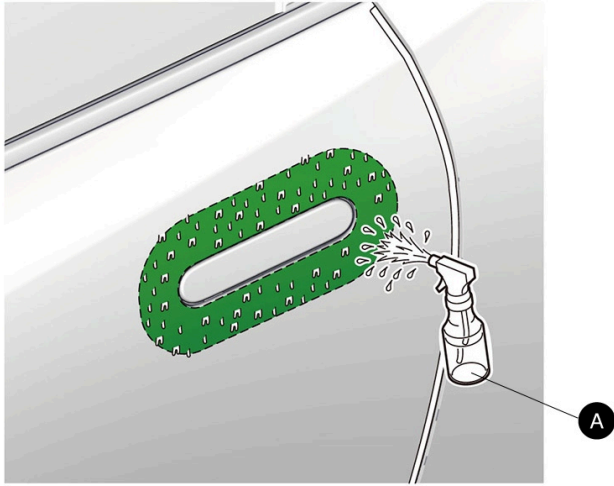

QP02916BD

A	3M PROTECTIVE TAPE APPLI- CATION SOLUTION
----------	--

11 Remove the adhesive backing.

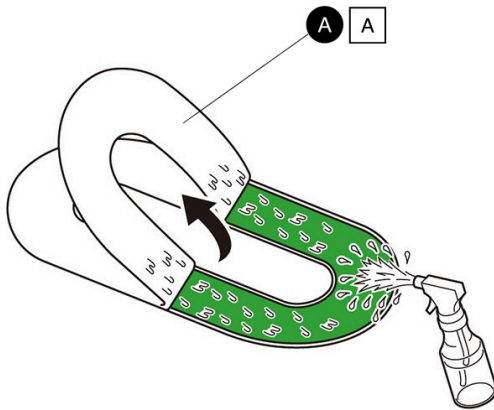

QP02917AD

A	ADHESIVE BACKING
A	Remove.

12 Spray the door handle film B.

13 Line up the door handle film B.

NOTE

Make sure to install the door handle film in the correct orientation.

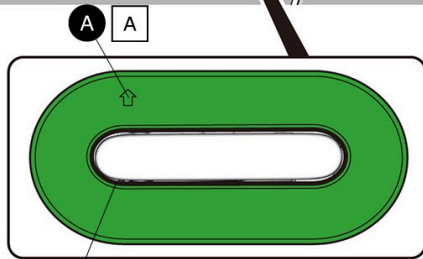
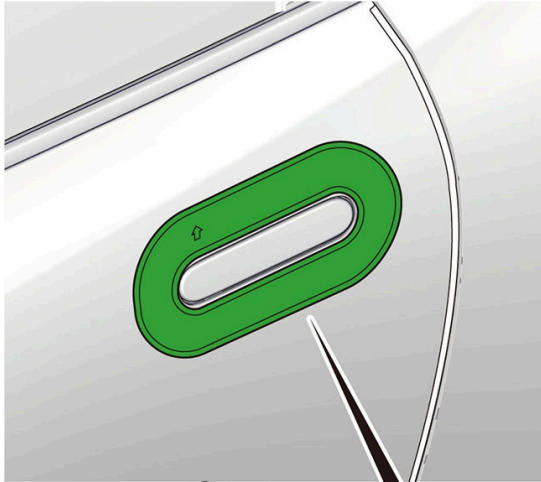

QP03001BD

A	ARROW MARK
B	PROTECTIVE FILM
A	Point up.
B	Line up with the end of the curved surface.

14 Secure the door handle film B.

NOTE

- Work in one direction only.
- Make sure that there are no air bubbles.

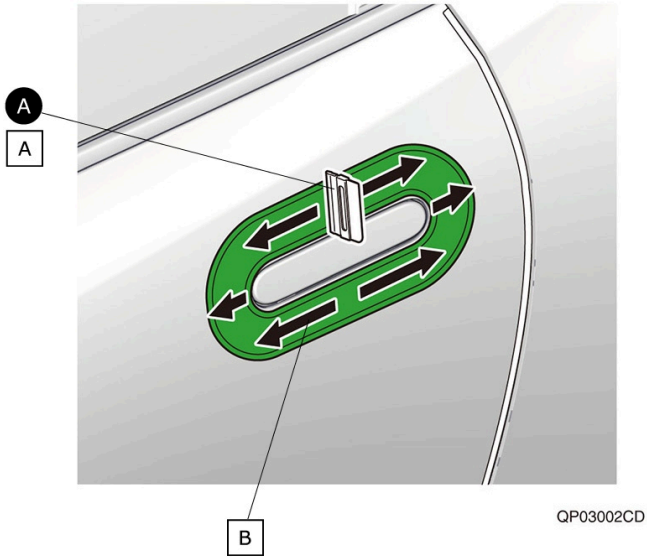

A	APPLICATOR
A	Use the felt side.
B	Work from the center to the outside.

15 Remove the protective film.

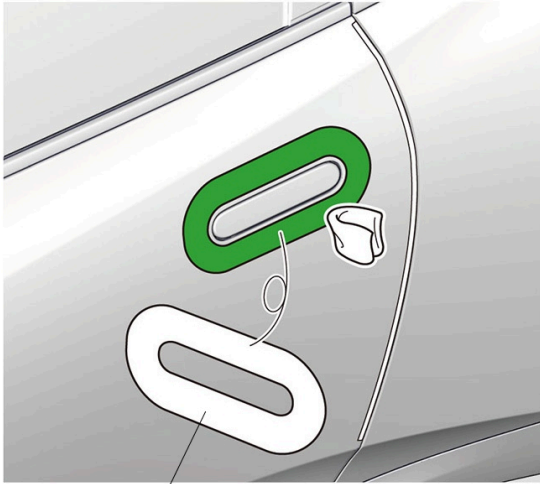

QP03003BD

A Remove.

16 Wipe off the 3M protective tape application solution.

 **NOTE**

Allow to dry thoroughly.

17 Clean the attaching area.

 NOTE

Allow to dry thoroughly.

A ALCOHOL WIPE

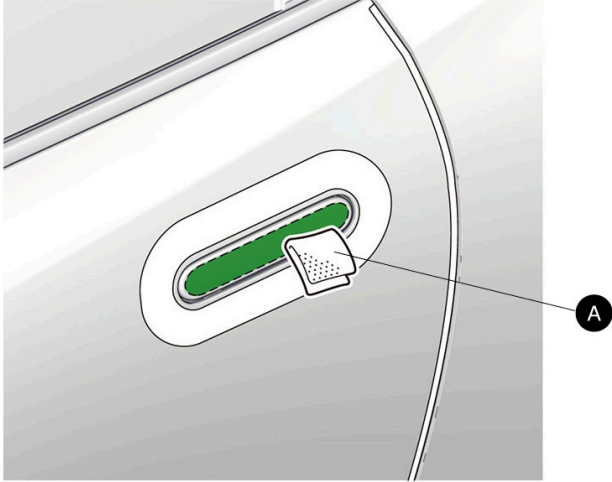

QP02909BD

18 Spray the left door handle.

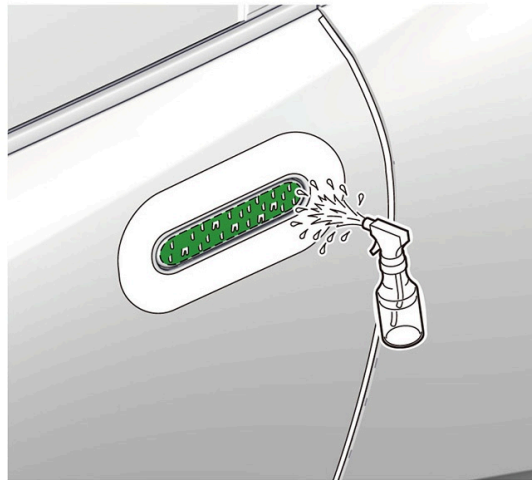

QP02910BD

19 Remove the adhesive backing.

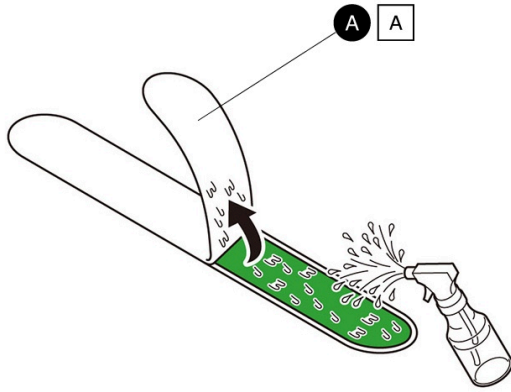

A	ADHESIVE BACKING
A	Remove.

QP02911AD

20 Spray the door handle film A.

21 Line up the door handle film A.

NOTE

Make sure to install the door handle film in the correct orientation.

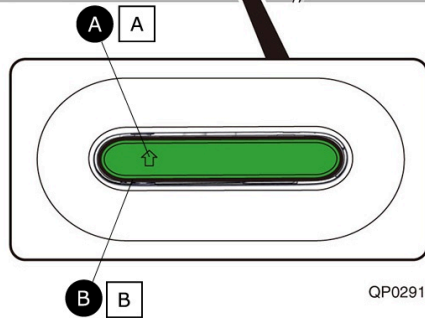
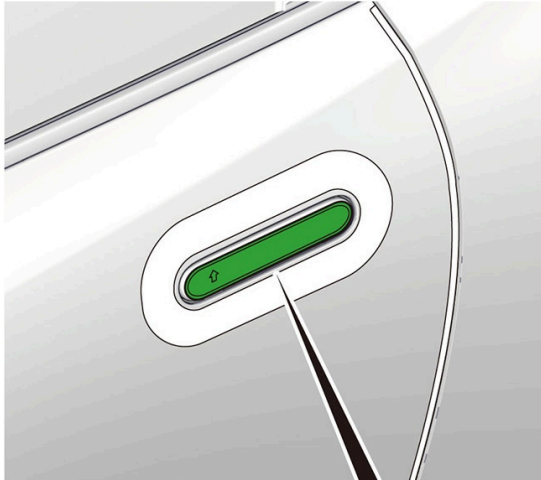

QP02912BD

A	ARROW MARK
B	PROTECTIVE FILM
A	Point up.
B	Line up with the end of the curved surface.

22 Secure the door handle film A.

NOTE

- Work in one direction only.
- Make sure that there are no air bubbles.

A

Work from the center to the outside.



A

QP02913CD

23 Remove the protective film.



A

QP02914BD

A Remove.

24 Wipe off the 3M protective tape application solution.

NOTE

Allow to dry thoroughly.

25 Repeat steps 9 through 24 on the other side.

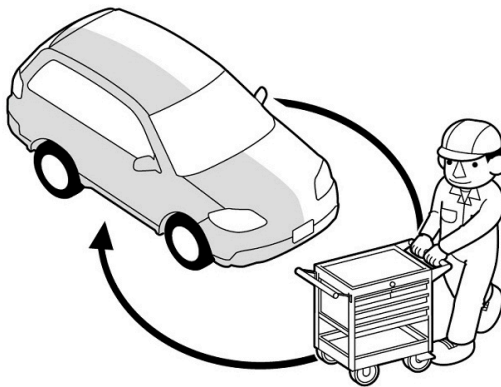

Q9D1014AM

Installing the Rear Bumper Appliques

26 Attach masking tape.

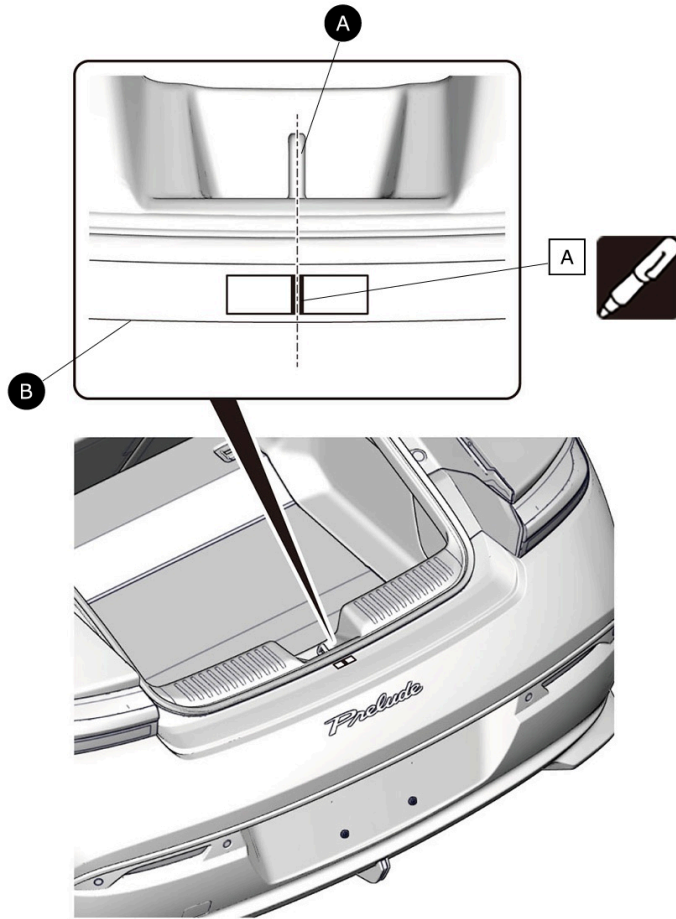
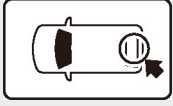

A	STRIKER
B	CHARACTER LINE
A	Line up with the center of the striker.

QP03005BD

27 Mark the masking tape.

28 Clean the attaching area.

NOTE

Allow to dry thoroughly.

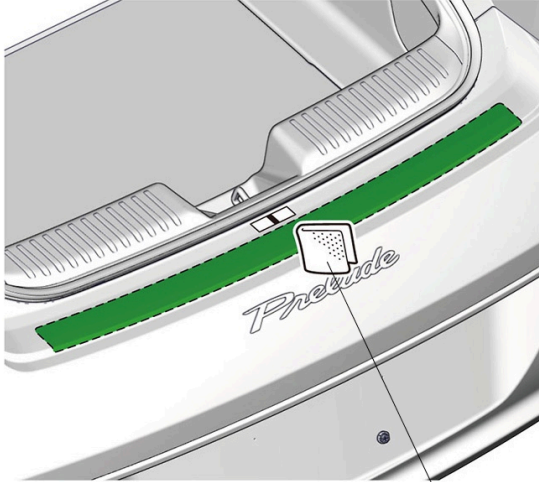

A QP03004BD

A ALCOHOL WIPE

29 Spray the rear bumper.

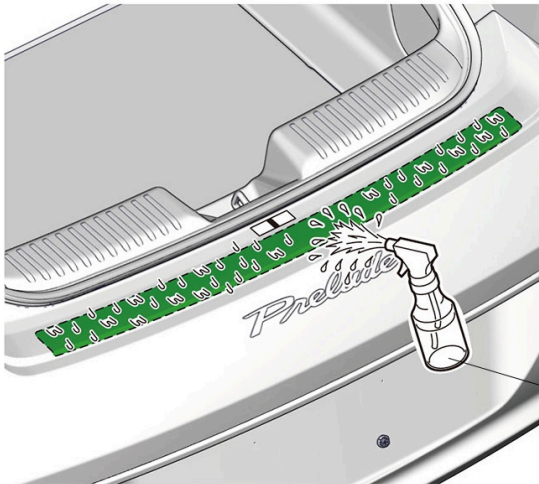

A

QP03006AD

A 3M PROTECTIVE TAPE APPLI-
CATION SOLUTION

30 Remove the adhesive backing.

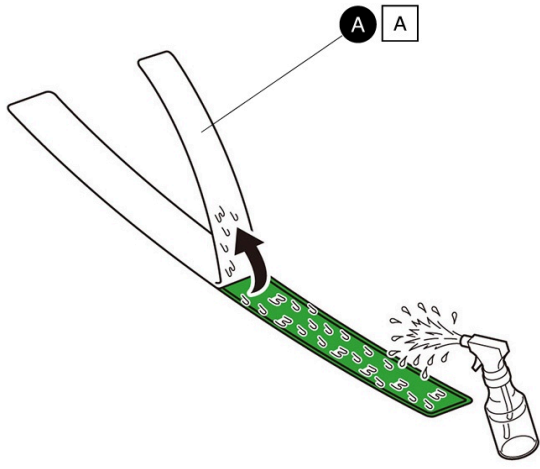

QP03009AD

A	ADHESIVE BACKING
A	Remove.

31 Spray the rear bumper applique A.

32 Line up the rear bumper applique A.

NOTE

Make sure to install the rear bumper applique in the correct orientation.

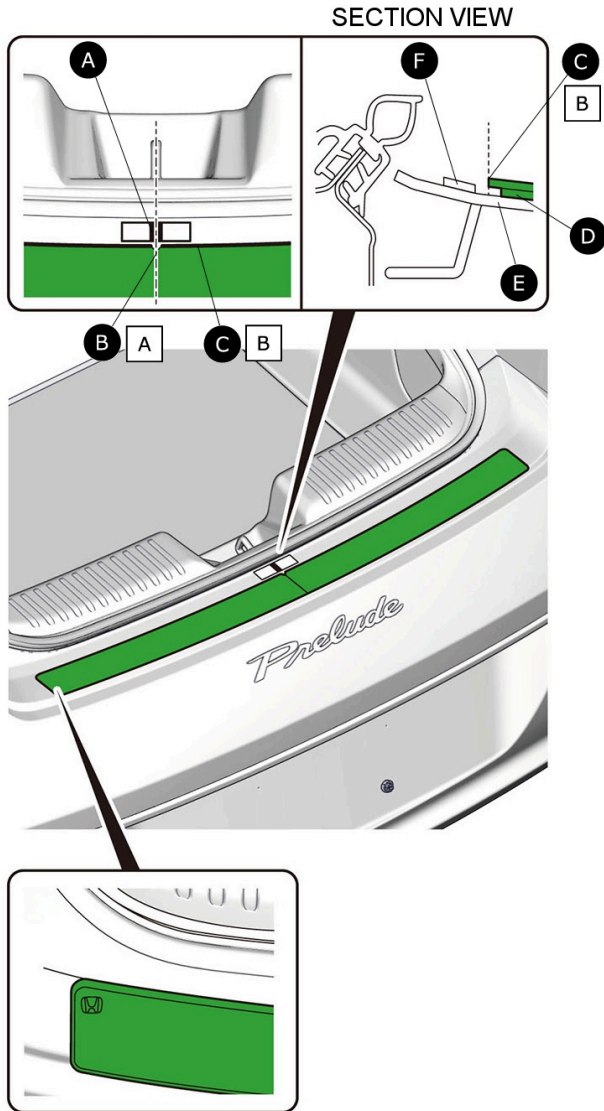

A	MARK
B	V-NOTCH
C	PROTECTIVE FILM
D	REAR BUMPER APPLIQUE A
E	REAR BUMPER
F	MASKING TAPE
A	Line up with the mark.
B	Line up with the character line.

QP03010CD

33 Secure the rear bumper applique A.

NOTE

- Work in one direction only.
- Make sure that there are no air bubbles.

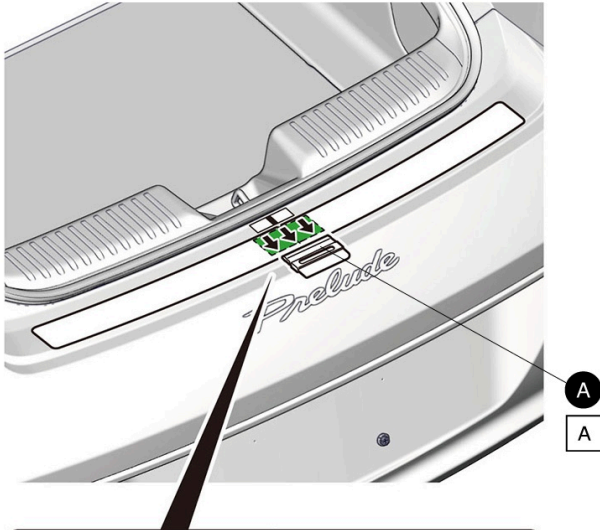

A	APPLICATOR
B	REAR BUMPER APPLIQUE A
C	REAR BUMPER
A	Use the felt side.
B	Work from the front to the rear.

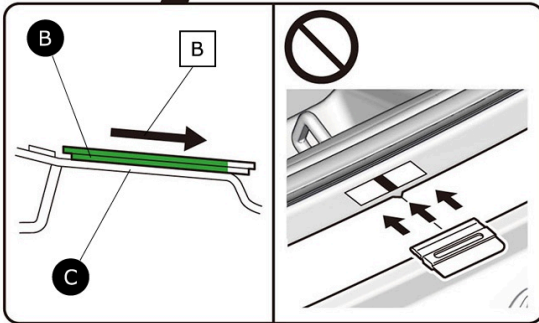

SECTION VIEW

QP03011CD

34 Secure the rear bumper applique A.

NOTE

- Work in one direction only.
- Make sure that there are no air bubbles.



A Work from the center to the outside.



QP03101CD

35 Remove the protective film.

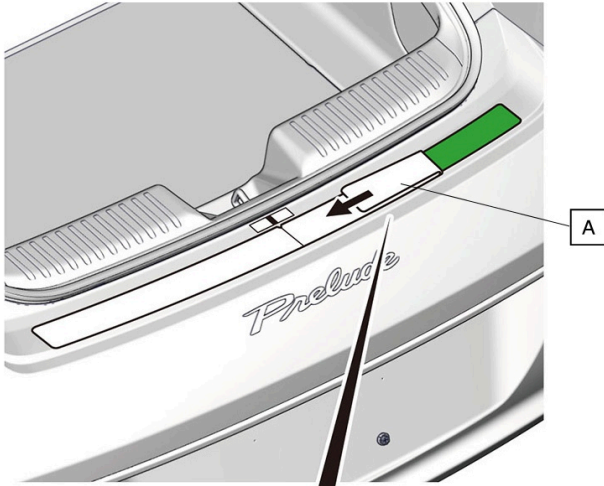

A	Remove.
B	Peel along the rear bumper applique A.
C	Do not pull up.

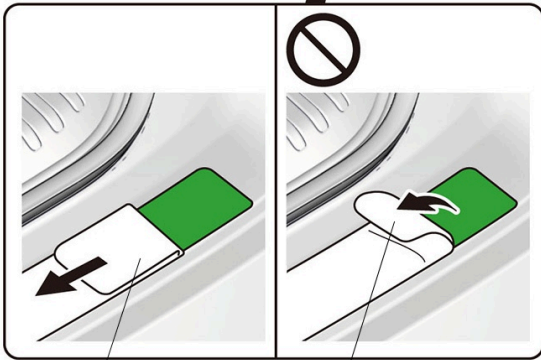

B

C

QP03102AD

36 Secure the rear bumper applique A.

NOTE

- Work in one direction only.
- Make sure that there are no air bubbles.

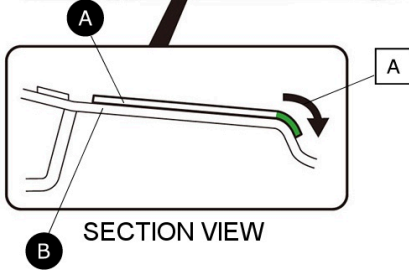
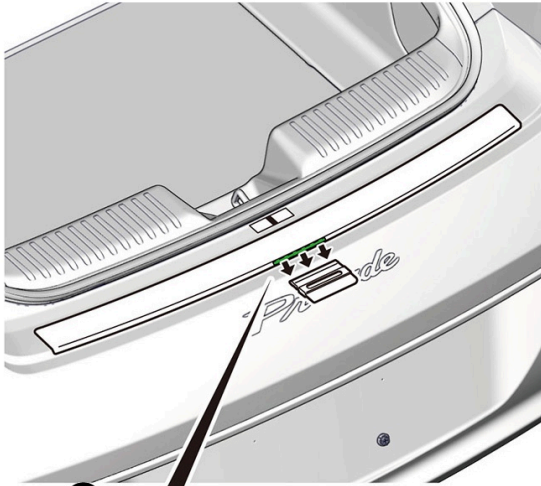

QP03103CD

A	REAR BUMPER APPLIQUE A
B	REAR BUMPER
A	Work from the upper side to the lower side.

37 Secure the rear bumper applique A.

NOTE

- Work in one direction only.
- Make sure that there are no air bubbles.

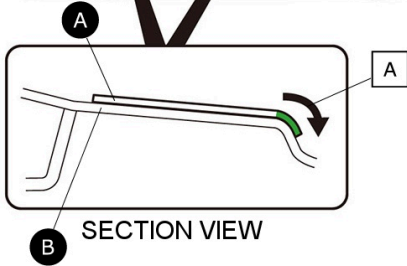
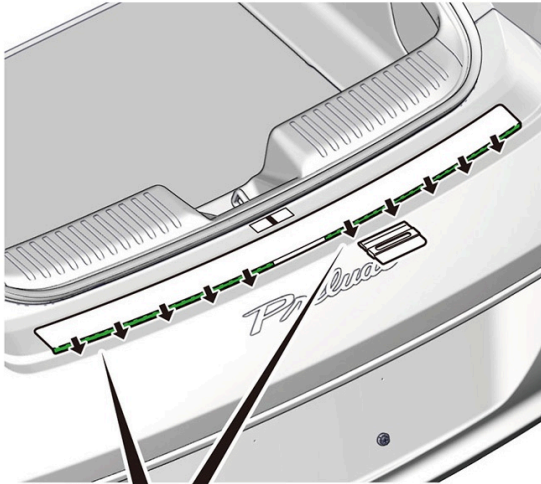

QP03104CD

A	REAR BUMPER APPLIQUE A
B	REAR BUMPER
A	Work from the upper side to the lower side.

38 Wipe off the 3M protective tape application solution.

NOTE

Allow to dry thoroughly.

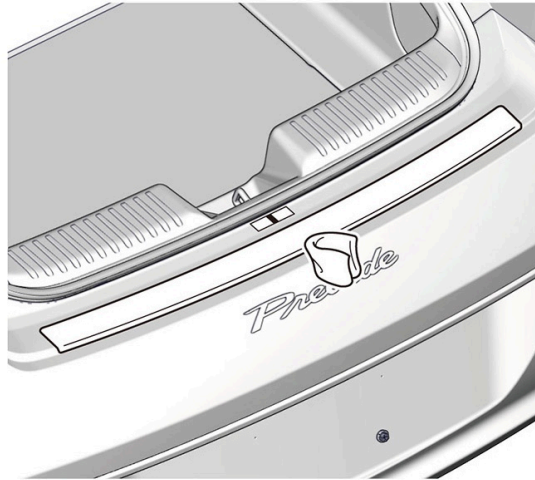

QP03105AD

39 Clean the attaching area.

NOTE

Allow to dry thoroughly.

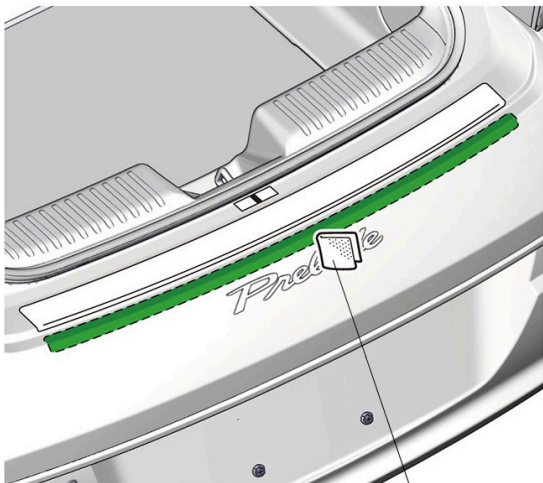

A

QP03106AD

A

ALCOHOL WIPE

40 Spray the rear bumper.

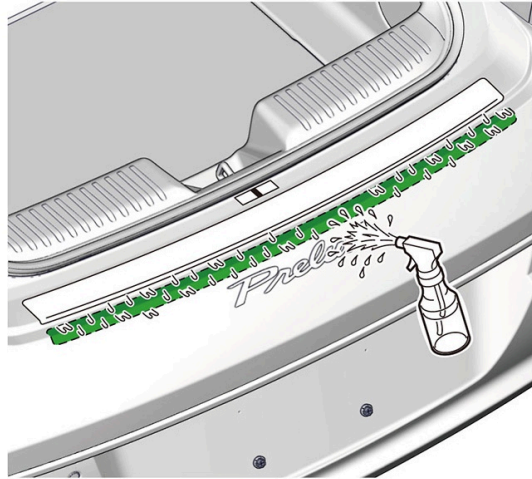

QP03107AD

41 Remove the adhesive backing.

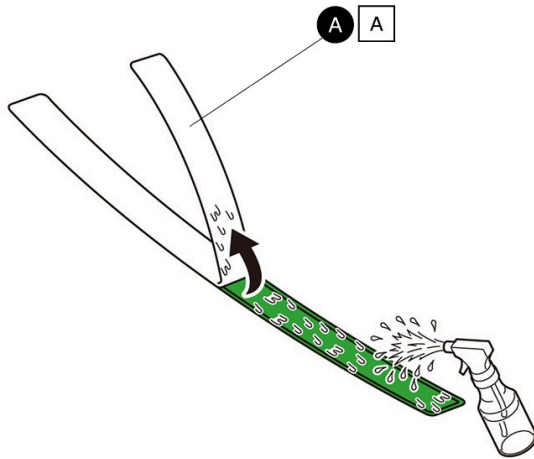

QP03108AD

A	ADHESIVE BACKING
A	Remove.

42 Spray the rear bumper applique B.

43 Line up the rear bumper applique B.

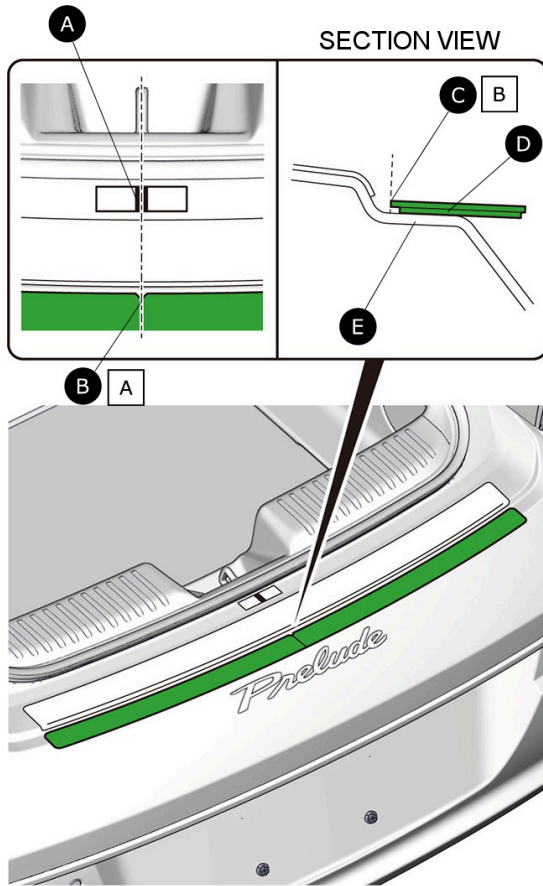

A	MARK
B	V-NOTCH
C	PROTECTIVE FILM
D	REAR BUMPER APPLIQUE B
E	REAR BUMPER
A	Line up with the mark.
B	Line up with the end of the curved surface.

QP03109CD

44 Secure the rear bumper applique B.

NOTE

- Work in one direction only.
- Make sure that there are no air bubbles.

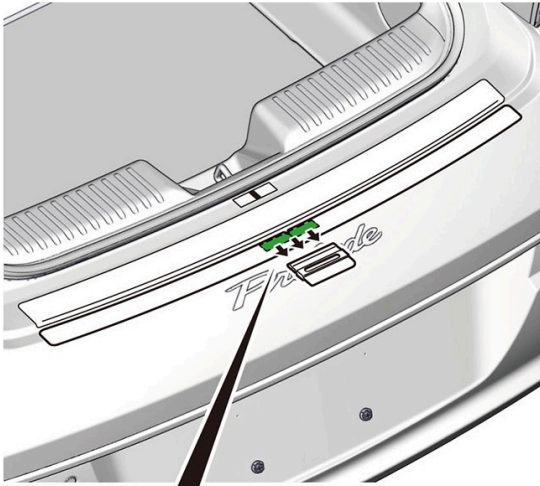

A	REAR BUMPER APPLIQUE B
B	REAR BUMPER
A	Work from the front to the rear.

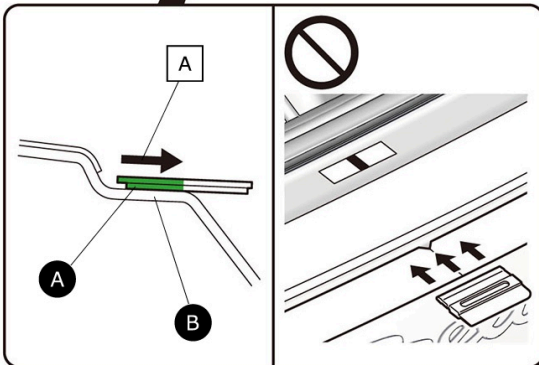

SECTION VIEW

QP03110DD

45 Secure the rear bumper applique B.

NOTE

- Work in one direction only.
- Make sure that there are no air bubbles.

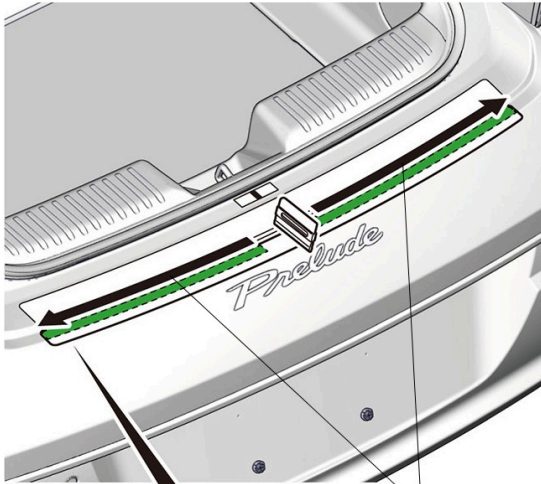

A

Work from the center to the outside.



QP03111CD

46 Remove the protective film.

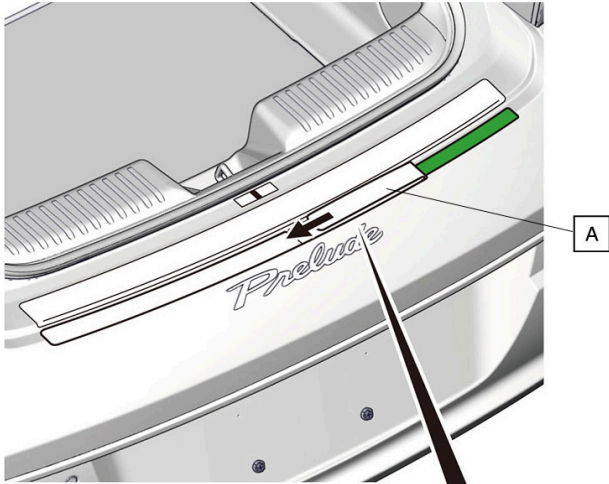

A	Remove.
B	Peel along the rear bumper applique B.
C	Do not pull up.

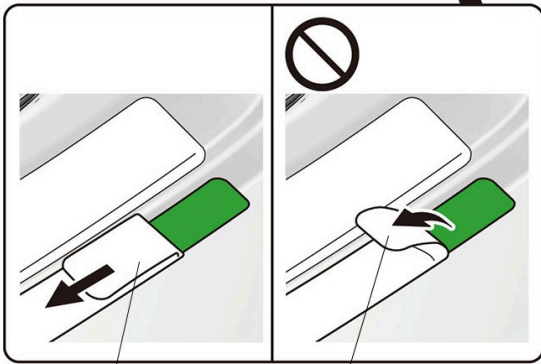

B

C

QP03112AD

47 Secure the rear bumper applique B.

NOTE

- Work in one direction only.
- Make sure that there are no air bubbles.

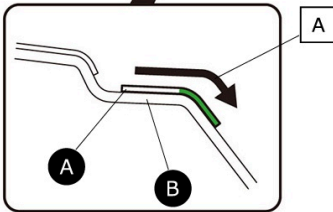
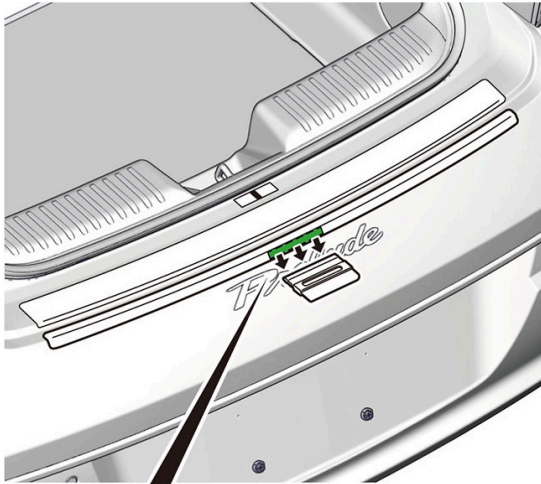

SECTION VIEW

QP03113CD

A	REAR BUMPER APPLIQUE B
B	REAR BUMPER
A	Work from the upper side to the lower side.

48 Secure the rear bumper applique B.

NOTE

- Work in one direction only.
- Make sure that there are no air bubbles.

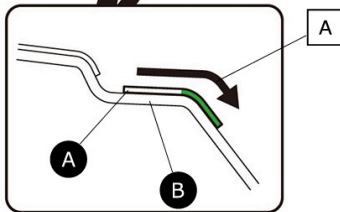
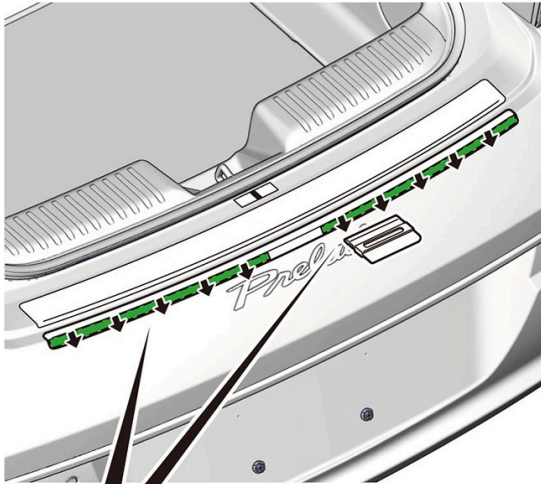

SECTION VIEW

QP03114CD

A	REAR BUMPER APPLIQUE B
B	REAR BUMPER
A	Work from the upper side to the lower side.

49 Wipe off the 3M protective tape application solution.

NOTE

Allow to dry thoroughly.

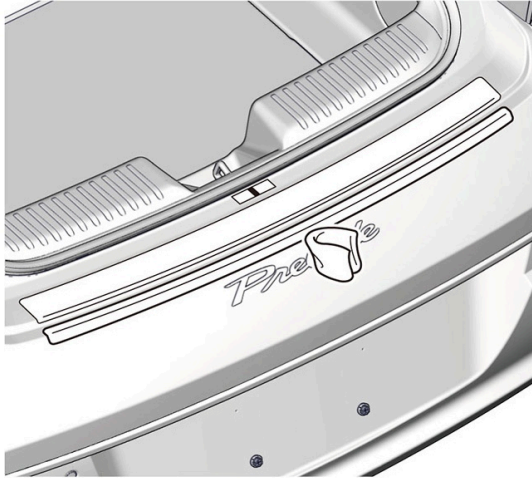

QP03115AD

50 Remove the masking tape.

51 Check that all parts are installed properly.