



INSTALLATION INSTRUCTIONS

Accessory
CARGO DIVIDER
P/N 08U45-SZA-100A

Application
2014 PILOT

Publications No.
All 50245
Issue Date
AUG 2013

Put this information in the glove box with the vehicle owner's manual.

PARTS LIST

4 Cargo dividers

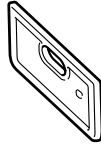

INSTALLATION

Installing the Cargo Dividers

1. Open the cargo lid.

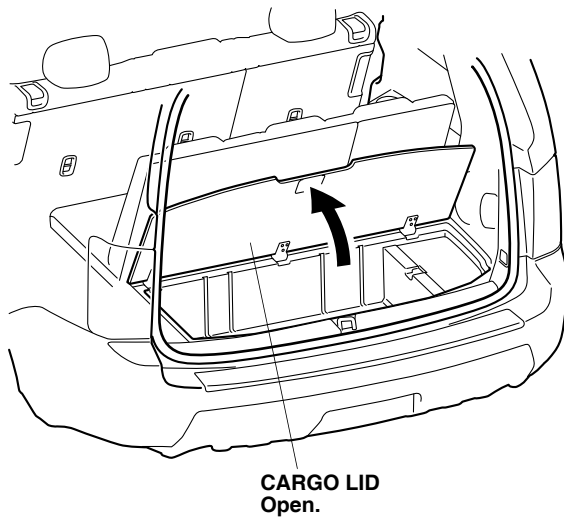

2. Insert four cargo dividers into the recess as shown.

