



**INSTALLATION
INSTRUCTIONS**

Accessory

**MOONROOF VISOR
P/N 08R01-SZA-101**

Application

2011 PILOT

Publications No.
All 43323-43637

Issue Date
MARCH 2010

PARTS LIST

Moonroof visor

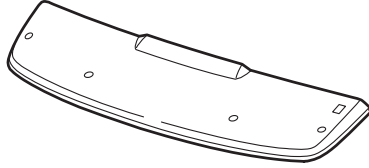

2 Brackets A



2 Brackets B

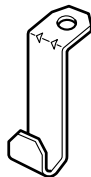

4 Screws



4 Nuts



4 Protective tapes



Sealer

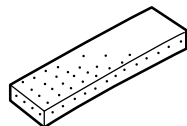

TOOLS AND SUPPLIES REQUIRED

Phillips screwdriver

10 mm Combination wrench

Scale

Isopropyl alcohol

Shop towels

Masking tape

Small phillips screwdriver

Torque screwdriver: T/N CDI401SM

Illustration of the Moonroof Visor Installed on the Vehicle

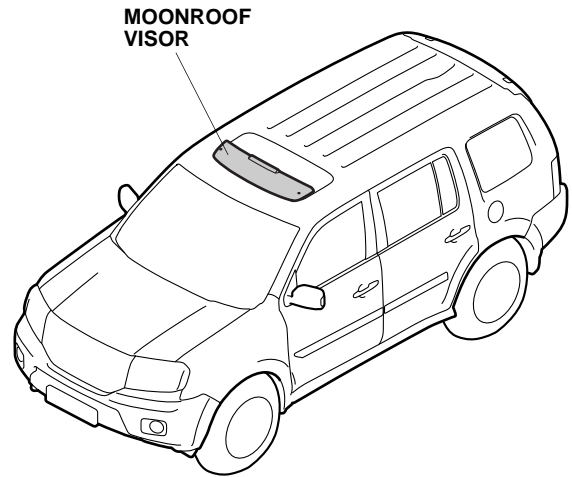

INSTALLATION

Customer Information: The information in this installation instruction is intended for use only by skilled technicians who have the proper tools, equipment, and training to correctly and safely add equipment to your vehicle. These procedures should not be attempted by "do-it-yourselfers."

NOTE:

- Install the accessory with care to avoid damaging the vehicle.
- Install the moonroof visor using the specified bolts and screws supplied. Never use a metal screw or nut to secure the moonroof visor.
- Wash and wax the area to be covered with a high-quality paste wax.

Installing the Moonroof Visor

1. Open the moonroof to the tilt up position.

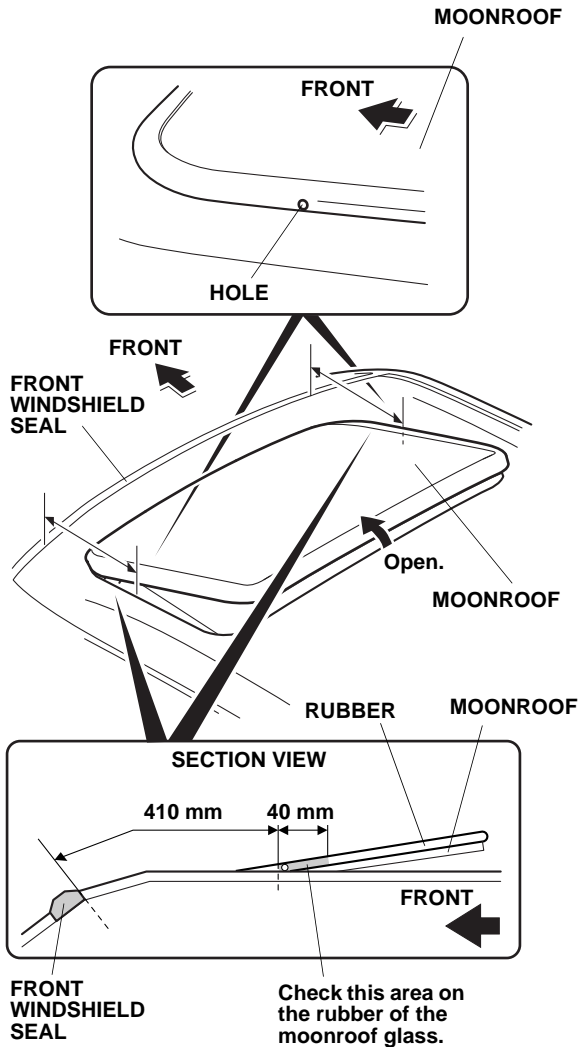

2. Using the measurements shown, check the rubber on the left and right side for a hole. If the rubber has a hole on either side, continue with step 3, otherwise, go to step 5.

3. Using a small phillips screwdriver, insert the sealer towards the rear side of the hole as shown.

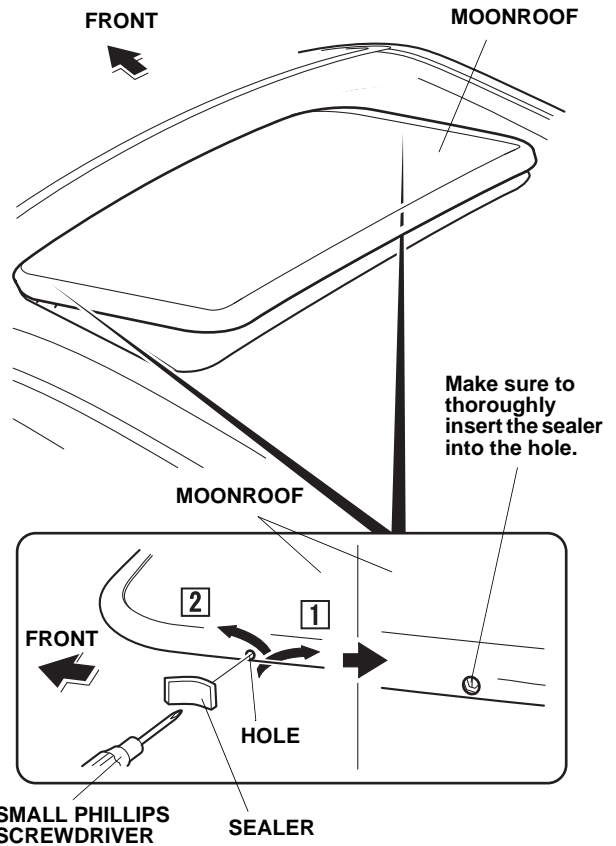

4. Insert the rest of the sealer towards the front of the hole as shown. Make sure to thoroughly insert the sealer into the hole.
5. Open the moonroof to the full open position.

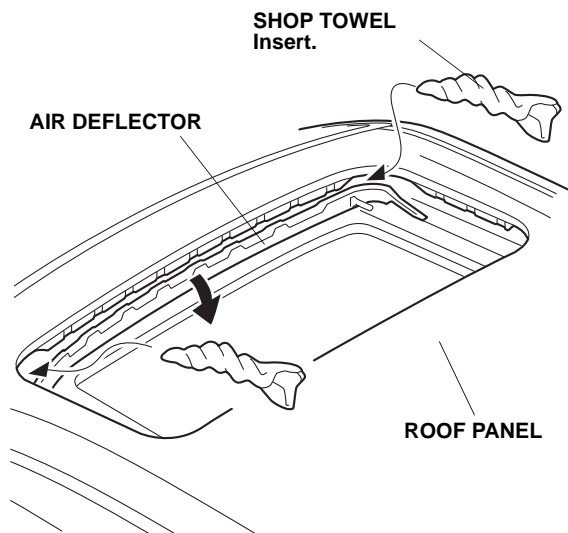

6. Roll up two shop towels and insert them between the roof panel and air deflector to lower the air deflector. Do not damage the air deflector.

7. Using isopropyl alcohol on a shop towel, thoroughly clean the roof panel where the protective tape will attach.

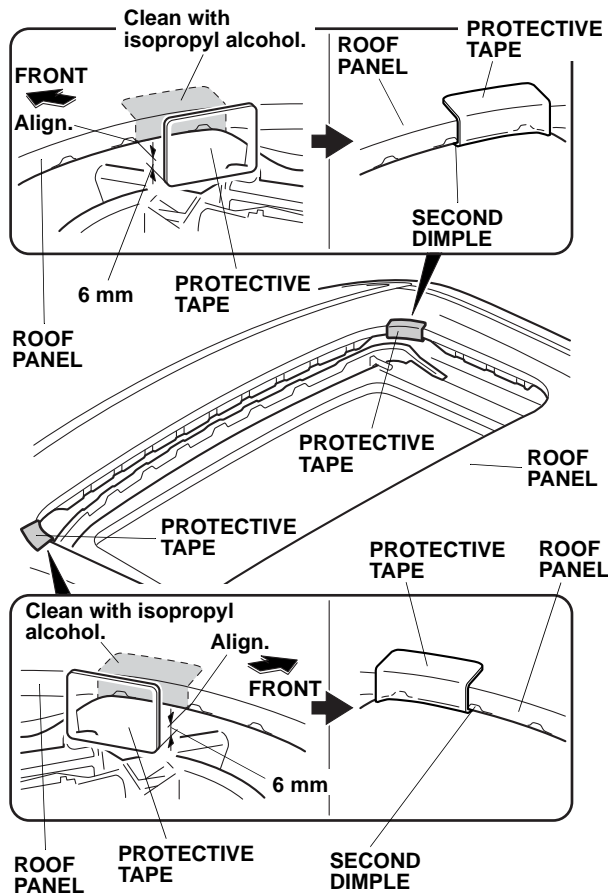

8. Locate the dimples at the right front corner of the moonroof opening. Remove the adhesive backing from one protective tape. Starting at the second dimple from the rear, wrap 6 mm of the protective tape around the bottom lip of the roof panel opening. Wrap the remaining portion of the protective tape up around the top of the roof panel. Install a protective tape to the left front corner of the moonroof opening the same way.

9. Using isopropyl alcohol on a shop towel, thoroughly clean the roof panel where the protective tape will attach.

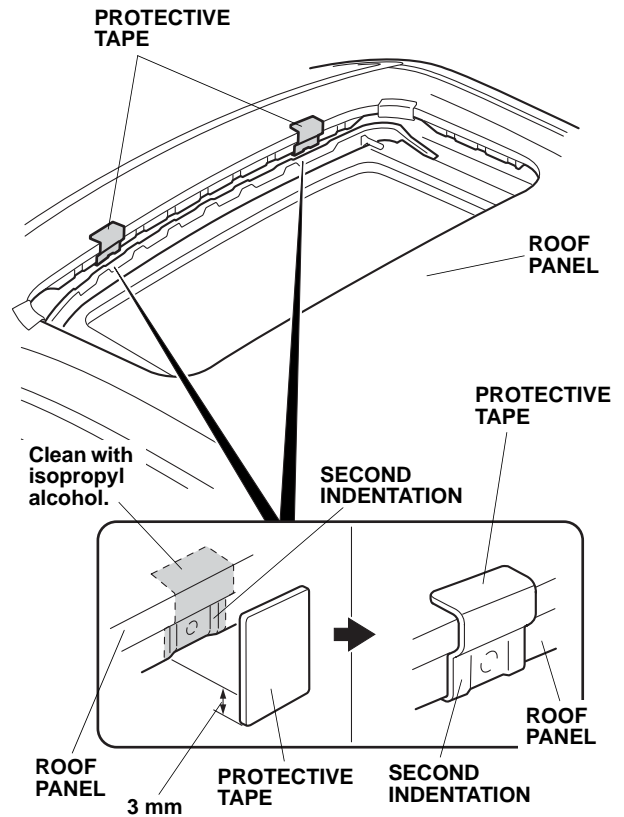

10. Locate the second indentation from the right front corner of the moonroof opening. Remove the adhesive backing from one protective tape. Starting from the bottom edge of the second indentation, wrap 6 mm of the protective tape around the lip of the roof panel opening. Wrap the remaining portion of protective tape up around the top of the roof panel. Install the protective tape to the second indent on the left side of the roof panel the same way.

11. Place one bracket B over each outer protective tape, and secure each bracket B in place with a piece of masking tape.

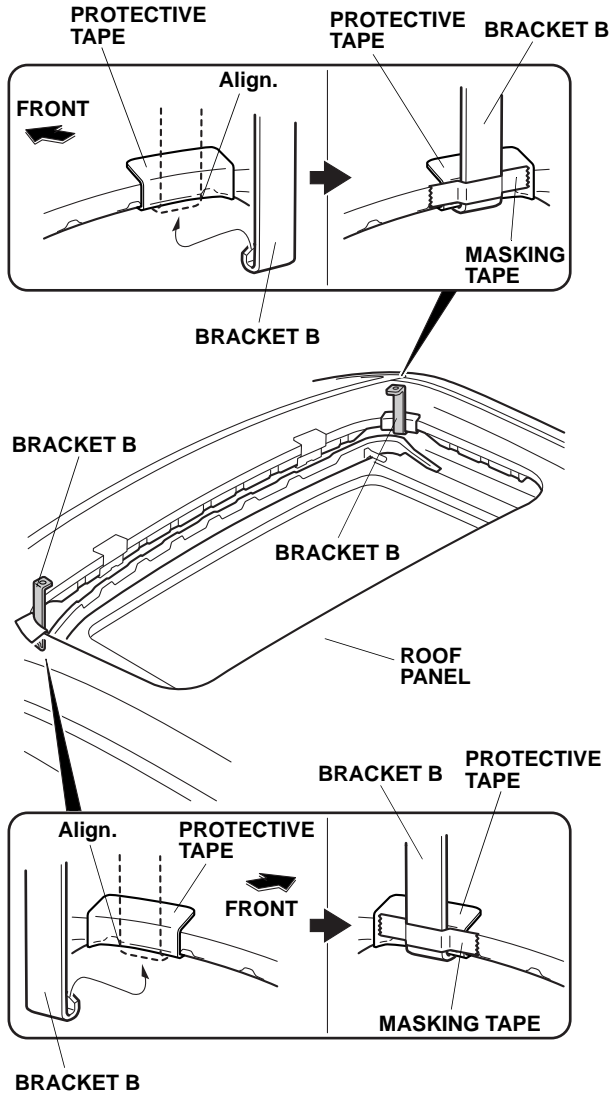

12. Place one bracket A over each inner protective tape, and secure each bracket A in place with a piece of masking tape.

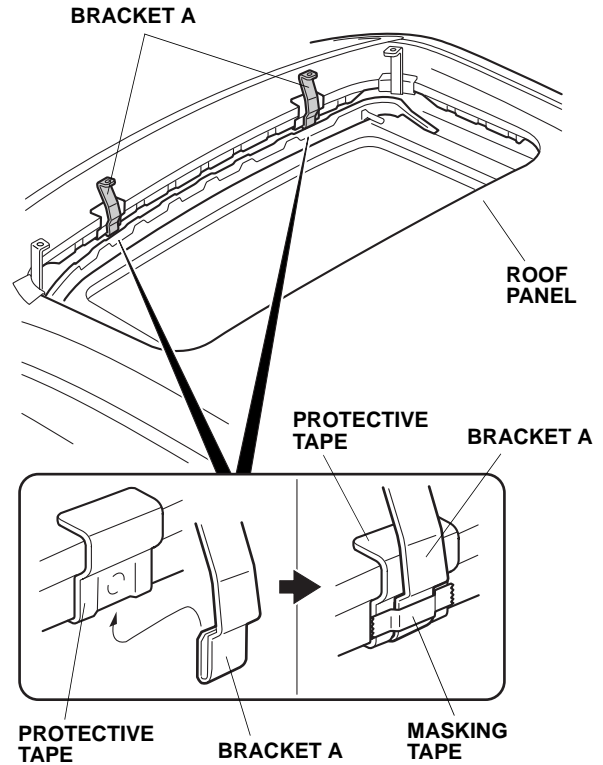

13. Align the holes in the moonroof visor with the holes in brackets A and B. Secure the moonroof visor to the brackets using the four screws and four nuts. Do not tighten the screws at this time.

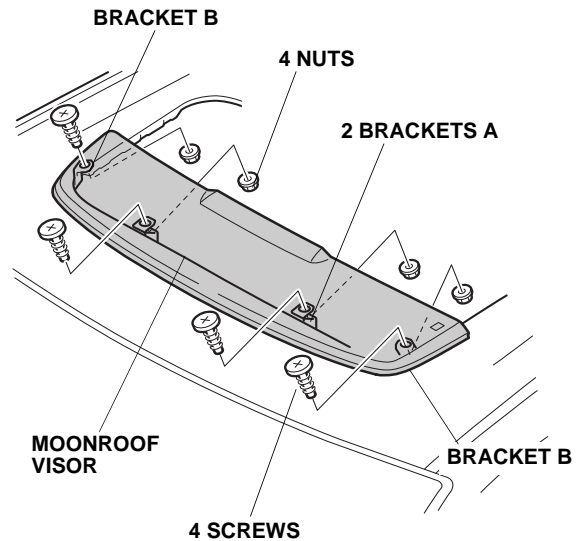

14. Adjust the position of the moonroof visor. Check that all of the brackets are firmly snug against the moonroof lip. Make sure the rubber molding on the moonroof visor is not twisted or rolled under the visor, and unfold if necessary.

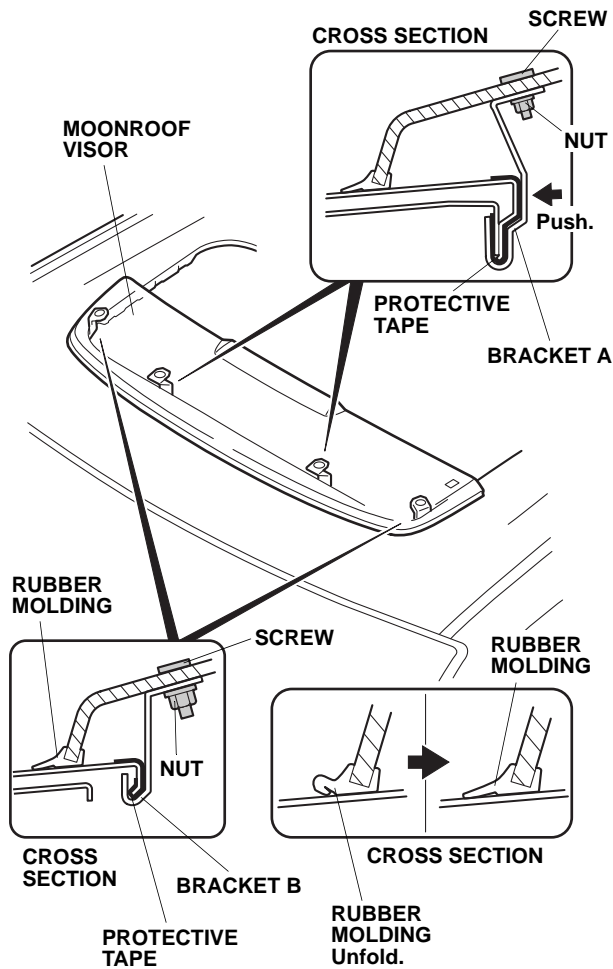

15. Tighten the screws and nuts while applying light pressure against the brackets. Make sure that there is no clearance between the brackets and the moonroof visor. Using a torque screwdriver, torque the screws and nuts: 2 N·m (1.5 lbf·ft)
16. Remove the masking tape and the shop towels.

17. Remove the IMPORTANT INFORMATION label from the moonroof visor.

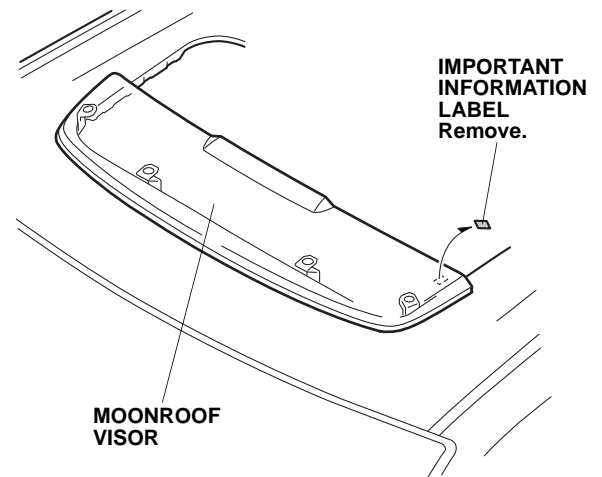

CARE OF THE MOONROOF VISOR

- To avoid damaging the surface, never use ammonia-based cleaners or solvents to clean the moonroof visor.
- Clean with a solution of mild dishwashing soap and a soft cloth or chamois.
- To remove scratches and restore the original luster, use Meguiar's Mirror Glaze plastic cleaner and polish or an equivalent high-quality plastic cleaner.