

CARGO LIGHT	2026 PASSPORT MODEL SERIES	Publications No. VERSION 1
-------------	-------------------------------	-------------------------------

### GENERAL VIEW

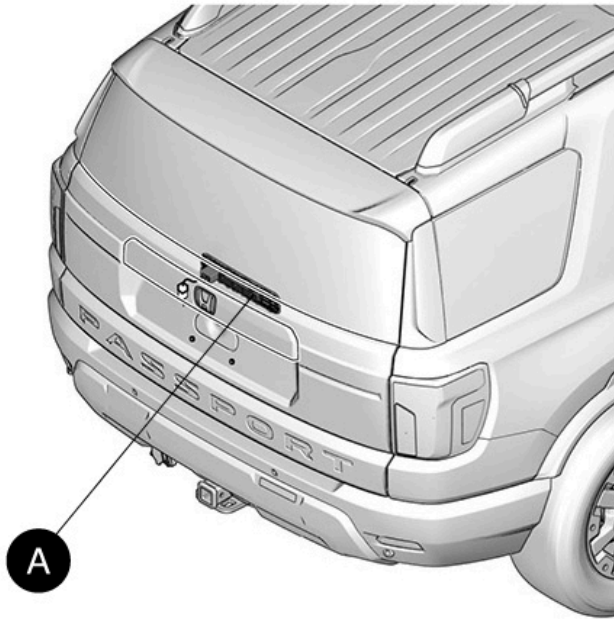

QP61401AB

<b>A</b>	CARGO LIGHT
----------	-------------

## FOR YOUR SAFETY (Read carefully.)

### Warning Symbols

Safety: Your safety, and the safety of others, is important. To help you make informed decisions about service procedures, we have provided safety messages where appropriate. Of course, it is not practical or possible to warn you about all the hazards associated with servicing a vehicle - you must use your own good judgment.

You will find important safety messages preceded by one of the following symbols:

\*All symbols are not used in all installation instructions.

#### DANGER

You will be killed or seriously hurt if you do not follow the instructions.

#### WARNING

You can be killed or seriously hurt if you do not follow the instructions.

#### CAUTION

You can be hurt if you do not follow the instructions.

#### NOTICE

Gives advice to prevent damage to the product, vehicle, the environment or other property.

#### NOTE

Gives helpful information or instructions to be followed when installing this product.











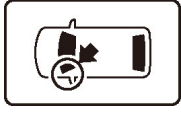
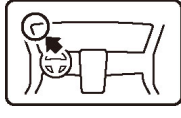



Indicates a prohibited action.



## Procedure and Location Icons

These icons indicate the work location and the worker's point of view.

\*All icons are not used in all installation instructions.

	The location on the vehicle.		The location in the vehicle. (Instrument panel.)
	Wear eye protection.		Wear heavy gloves.
	Use an assistant.		Place the part on a blanket.
	Work perpendicular.		Remove any burrs.
	Use touch-up paint and allow to dry.		Tighten to the specified torque.
	Apply firm pressure while rolling, especially at the ends, to set the adhesive.		Press firmly.
	Clean with isopropyl alcohol.		Return the original part to the customer. (Do not reuse.)

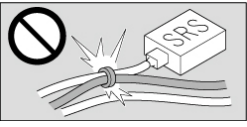
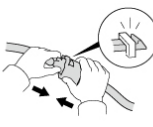
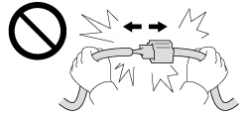
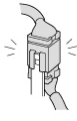
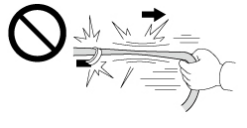
## Wire Harness Routing Precaution

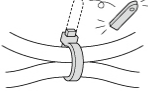
	<p>Do not secure the accessory harness to the SRS harness. (except for instruction cases.)</p>		<p>Push the connectors and terminals together until they lock.</p>
	<p>Do not pull the harness to unplug the connectors.</p>		<p>Install removed connectors in their original location.</p>
	<p>Do not pull the harness.</p>		<p>Secure the accessory harness as shown.</p>
	<p>Do not pinch the harness.</p>		<p>Cut off the excess wire tie.</p>

## Safety: General

- Observe all safety notes and precautions described in the service information, in addition to those described in this Installation Instruction. Be extremely careful for your safety and safety of others.
- Always use the parts and tools specified in the installation instructions.
- Be careful not to damage the vehicle or the parts.
- Be extremely careful when handling retaining tabs and clips.
- Note the locations of the parts before removing them so they can be properly installed in their original positions.
- The illustrations may differ slightly from the actual accessory.

## Safety: Electric Parts

Always disconnect the negative cable from the battery before beginning work.

## PARTS LIST

### ■ Cargo Light Kit (P/N 08V30-3BM-100) (P/N 08V30-3BM-P00)

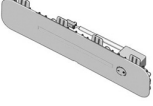
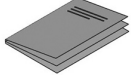
Parts	Parts name	QTY	Remarks
	Cargo light	1	
	Accessory User's Information Manual	1	

## REQUIRED TOOLS AND SUPPLIES

10 mm Open end wrench

The following tools are available through the Honda Tool and Equipment Program:

- Plastic Trim Tool (T/N SILTRIMTL10)
- Trim Tool Set (T/N SOJATP2014)

## INSTALLATION

### ■ Disconnecting the Battery Cable

#### ● Resonator

- 1 Remove the resonator.

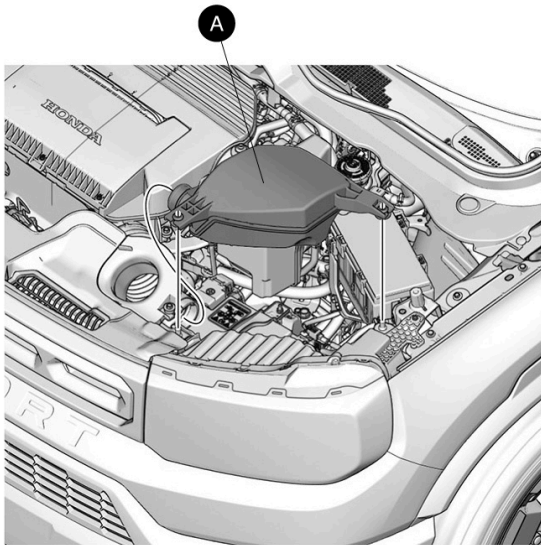
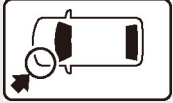

<b>A</b>	RESONATOR
----------	-----------

QP62602AB

## ● Negative Cable

**2** Disconnect the negative cable from the battery.

### NOTE

Follow the “12 Volt Battery Terminal Disconnection and Reconnection” described in the service information since the work differs depending on the vehicle.

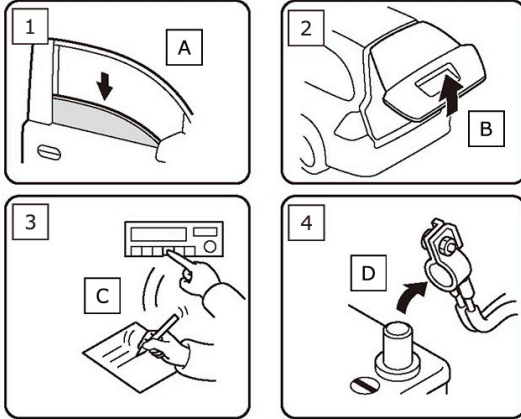

QCD0504BM

A	Lower.
B	Open.
C	Record.
D	Disconnect.



## Removing the Vehicle Parts

### ● Upper Lid

**3** Remove the upper lid.

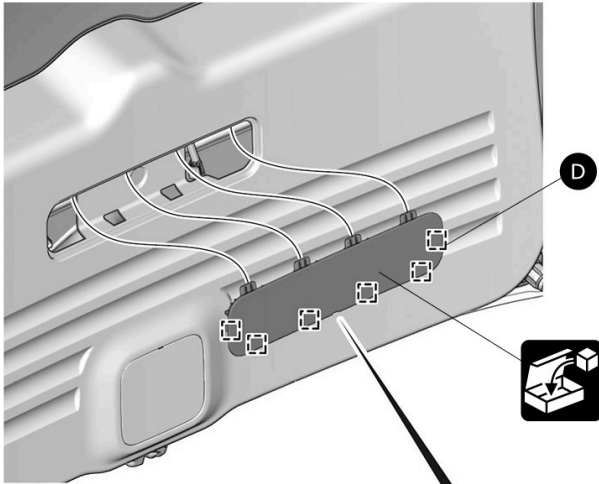
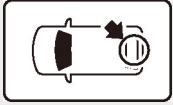

<b>A</b>	UPPER LID
<b>B</b>	SLOT
<b>C</b>	PLASTIC TRIM TOOL
<b>D</b>	RETAINING TAB(6)

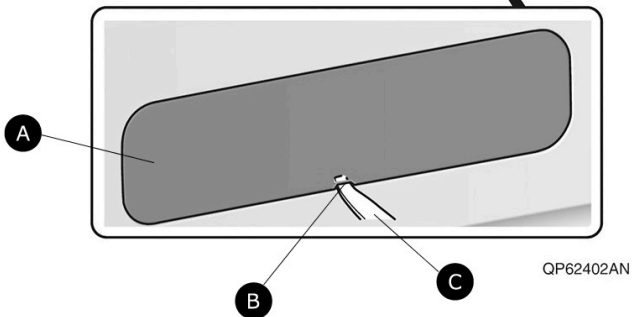

## Installing the Cargo Light

**4** Plug-in the cargo light connector.

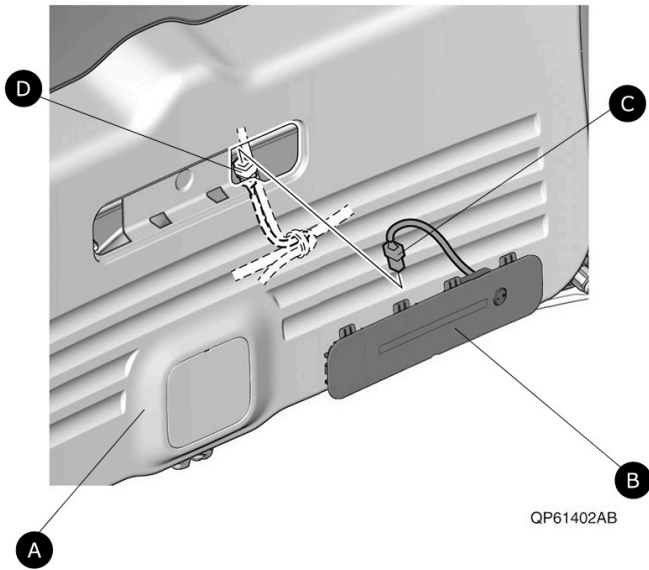
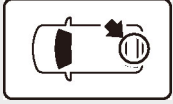

<b>A</b>	TAILGATE LOWER TRIM PANEL
<b>B</b>	CARGO LIGHT
<b>C</b>	CARGO LIGHT 2-PIN CONNECTOR
<b>D</b>	VEHICLE 2-PIN CONNECTOR

**5** Install the cargo light.

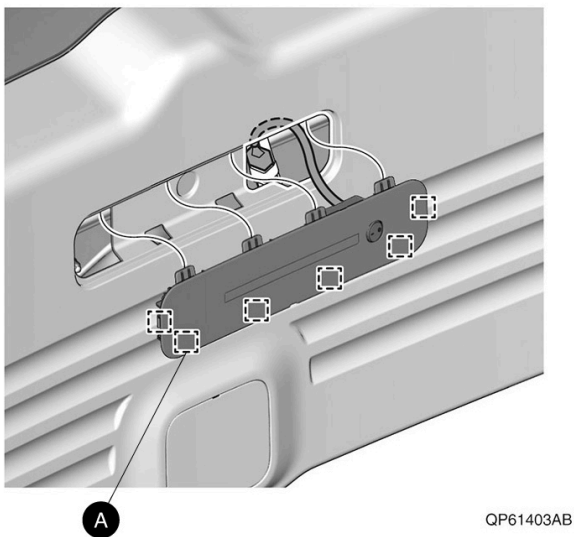

<b>A</b>	RETAINING TAB(6)
----------	------------------

## Check After Installation

**6** Check that all parts are installed and properly routed.

### NOTE

- Check that all harnesses are not pulled or pinched.
- Make sure all clips and wire ties are securely installed.

## Operation Check

**7** Connect the negative cable to the battery.

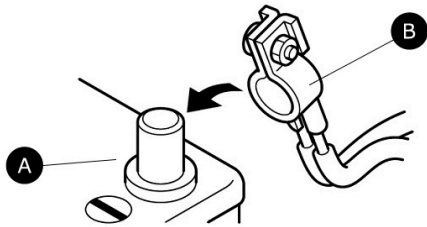

Q060702BM

<b>A</b>	BATTERY
<b>B</b>	NEGATIVE CABLE

**8** Install the resonator.

**9** Make sure the accessory operates as described in the Accessory User's Information Manual.

## Vehicle Check

**10** Make sure all accessories and systems operate properly.

**11** If necessary, restore the systems back to normal operation as described in the service information.

**12** Press and hold the audio unit power button for 2 seconds to restore the audio and navi (if equipped) system functions.

## Give the following item(s) to your customer:

Accessory User's Information Manual