



## INSTALLATION INSTRUCTIONS

Accessory  
ALL-SEASON FLOOR MATS  
P/N 08P17-THR-100A

Application  
2022 ODYSSEY

Publications No.  
**VERSION 1**  
Issue Date  
**JAN 2021**

### PARTS LIST

Driver's all-season floor mat

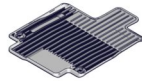

Passenger's all-season floor mat

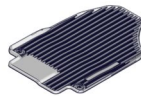

Second row all-season floor mat

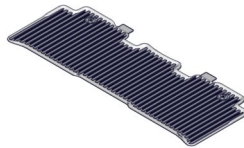

Third row all-season floor mat



### Illustration of the All-Season Floor Mats in the Vehicle

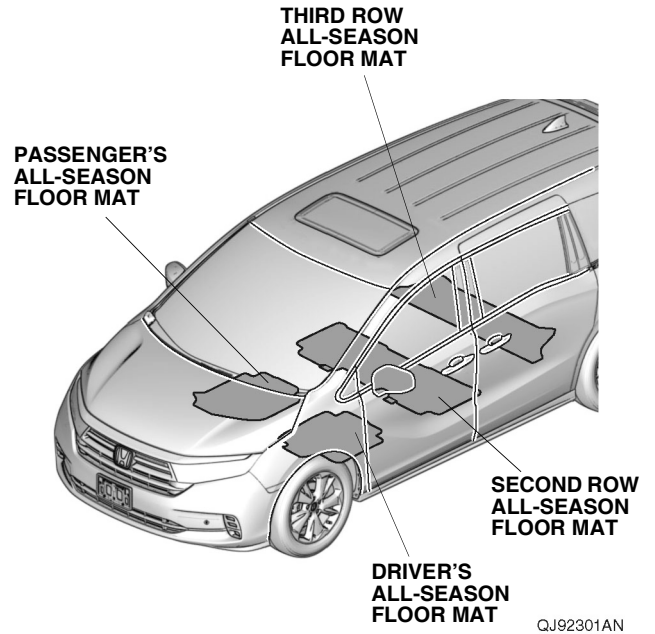

### INSTALLATION

#### NOTE:

- Before installing the mats, identify their installation positions.
- Connect the mats to the anchors to prevent the mats from sliding forward and possibly interfering with the pedals.
- If you remove a mat, make sure you re-anchor it when you put it back in your vehicle.
- If you replace a mat, use a factory mat designed to be used with the anchors.
- If you use a non-factory mat in the driver's footwell, make sure it fits properly and that it can be used with the anchors.
- Do not put an additional mat on top of the anchored mat. It may slide forward and possibly interfere with the pedals.
- Position the rear seat floor mat properly. If they are not properly positioned, the floor mat can interfere with the front seat functions.

## Installing the All-Season Floor Mats

1. Remove the standard floor mats.

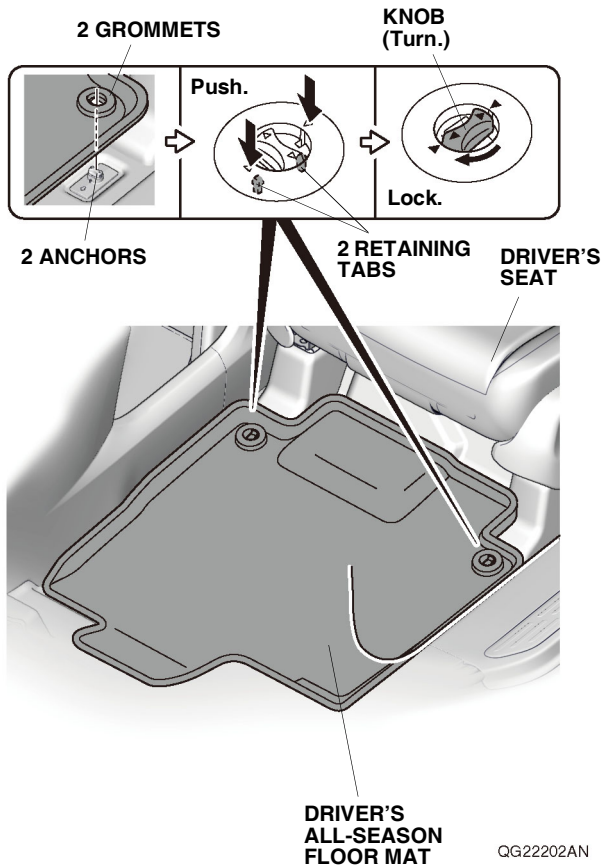

2. Place the grommets in the driver's all-season floor mat over the anchors. Push the grommets into the anchors to secure the retaining tabs, then turn the knobs 90° to secure the driver's all-season floor mat.

3. Place the grommets in the passenger's all-season floor mat over the anchors. Push the grommets into the anchors to secure the retaining tabs, then turn the knobs 90° to secure the passenger's all-season floor mat.

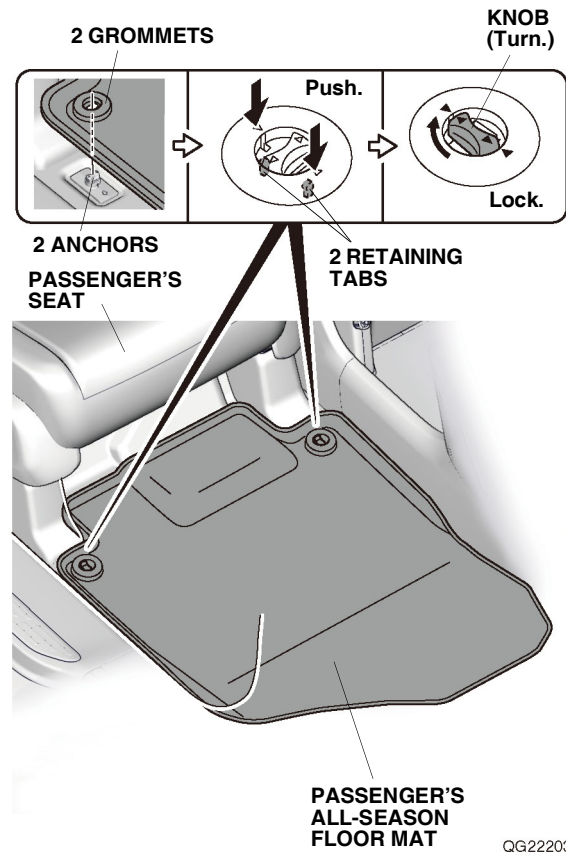

4. Insert the two tabs on the second row all-season floor mat under the two air vents. Place the grommets in the second row all-season floor mat over the anchors. Push the grommets into the anchors to secure the retaining tabs, then turn the knobs 90° to secure the second row all-season floor mat.

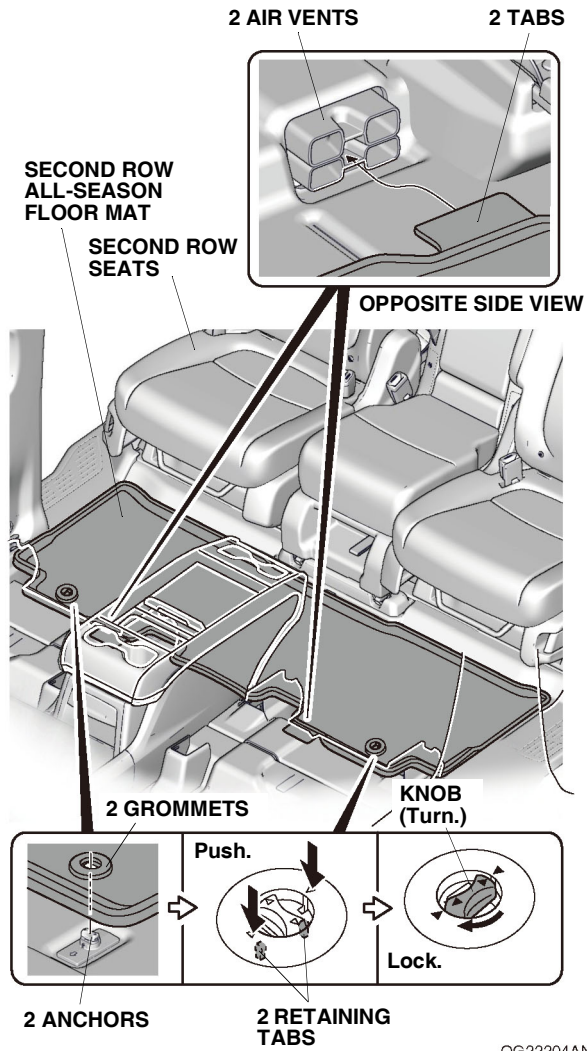

5. Place the third row all-season floor mat as shown.

