



INSTALLATION INSTRUCTIONS

Accessory
ROOF RAILS
 P/N 08L02-THR-101
 P/N 08L02-THR-101A

Application
2019 ODYSSEY

Publications No.
VERSION 1
 Issue Date
MAR 2018

PARTS LIST

Left roof rail



Left front roof rail cover



Left rear roof rail cover



Left center stay



Right roof rail



Right front roof rail cover



Right rear roof rail cover



Right center stay



12 TORX nuts



4 TORX bolts



4 TORX screws



2 Spacers



4 Plugs



2 Roof molding cover clips



2 Molding clips



TOOLS AND SUPPLIES REQUIRED

Phillips screwdriver

Putty knife

Ratchet

Needle nose pliers

Masking tape

Torque wrench

Ruler

Tape measure

Felt-tip pen

File

T-15 and T-30 TORX bits

Eye protection (face shield, safety goggles, etc.)

The following tools are available through the Honda Tool and Equipment Program. On the iN, click on Service > Service Bay > Tool and Equipment Program, then enter the number under "Search." Or, call 888-424-6857.

- Trim Tool Set (T/N SOJATP2014)
- Plastic Trim Tool (T/N SILTRIMTL10)
- Air Saw (T/N AT192A)

Illustration of the Roof Rails Installed on the Vehicle

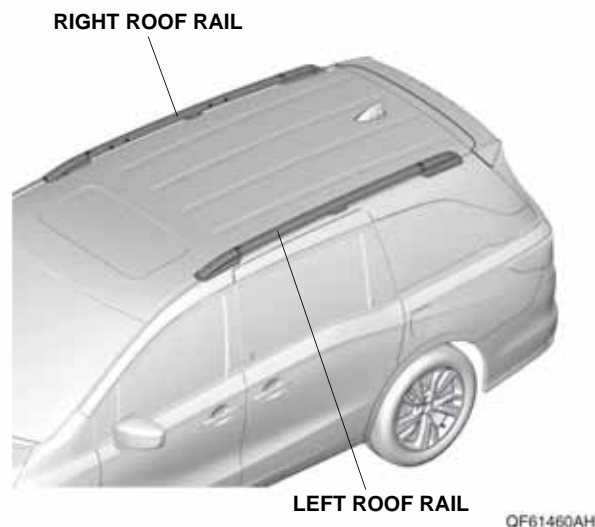

INSTALLATION

Customer Information: The information in this installation instruction is intended for use only by skilled technicians who have the proper tools, equipment, and training to correctly and safely add equipment to your vehicle. These procedures should not be attempted by "do-it-yourselfers."

NOTE:

- Be extremely careful not to damage the roof and other finished surfaces of the body when installing the roof rails.
- The weight of the cargo must not exceed the maximum weight capacity of 75 kg (165 lb.)

1. Apply one piece of masking tape on the vehicle panel and one on the left roof molding as shown. Using a felt-tip pen, draw a line in the center on each piece of masking tape as shown.

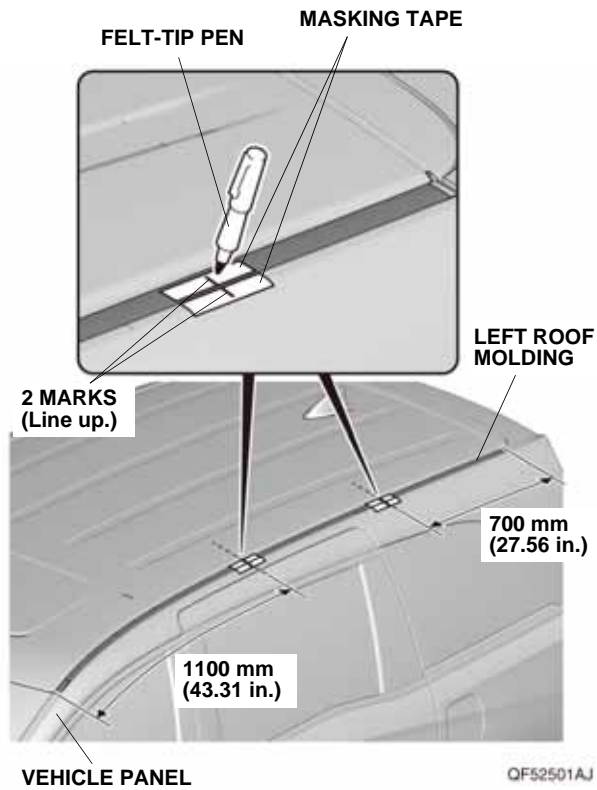

2. Using a plastic trim tool, carefully remove the left roof molding.

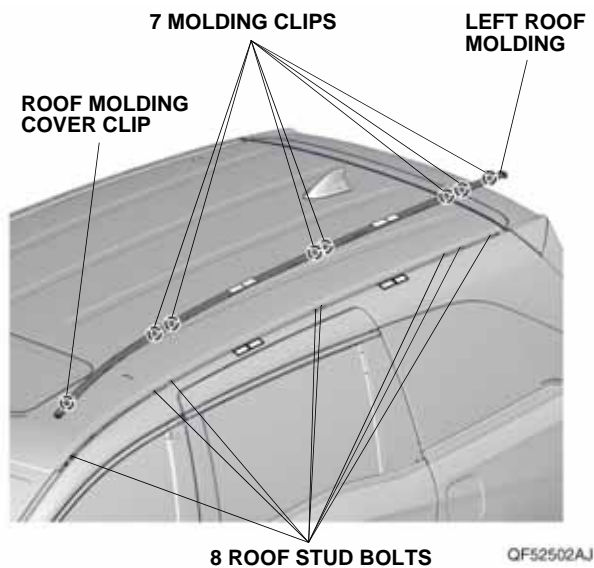

3. Using needle nose pliers, remove the seven molding clips and the roof molding cover clip from either the molding or the roof stud bolts.

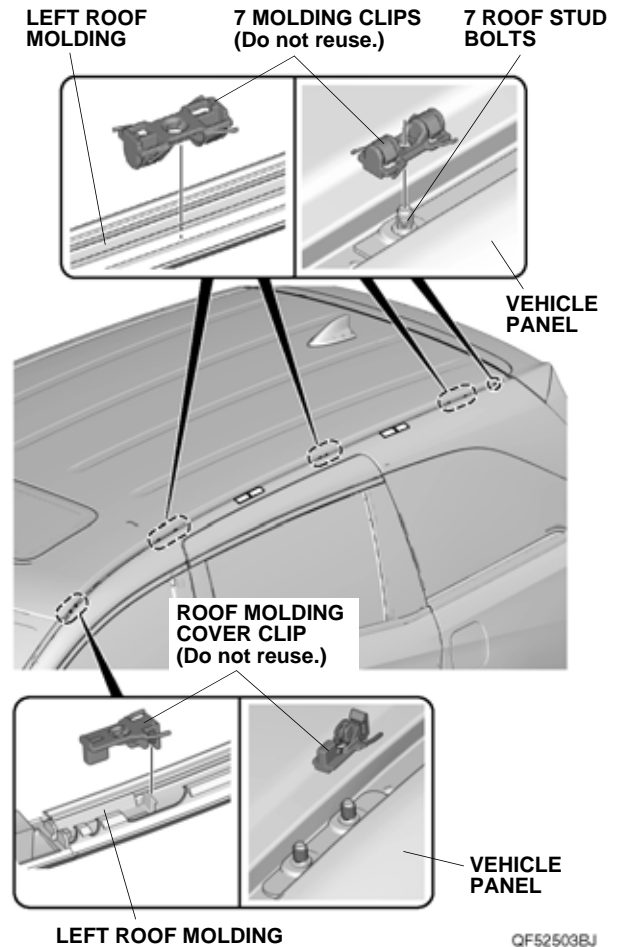

4. Using a putty knife, remove any excess sealant from the roof stud bolts.

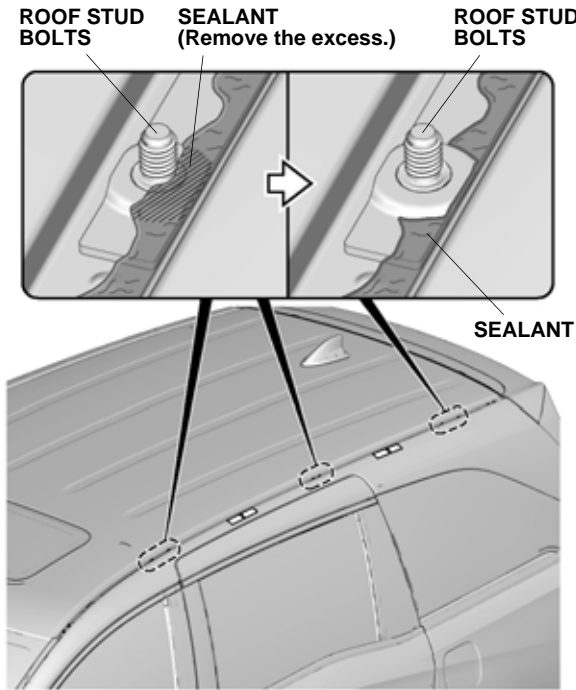

QF52504BJ

5. Measure and use a felt-tip pen to mark the molding as shown.

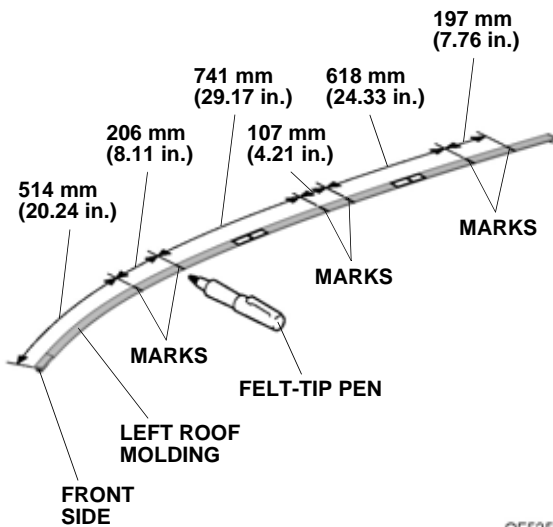

QF52505AJ

6. While wearing eye protection, use an air saw to cut the molding at the marks made in step 5. Remove any burrs.

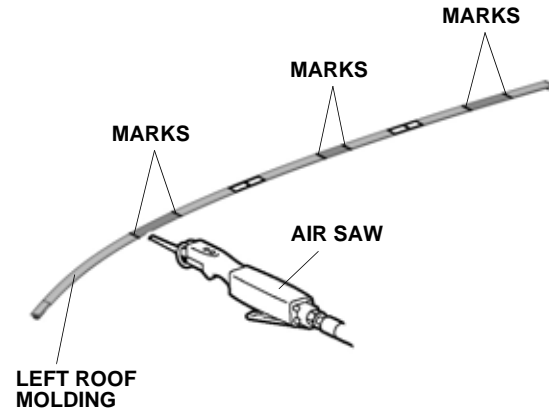

QF52506AJ

7. Install the new roof molding cover clip on the molding (front).

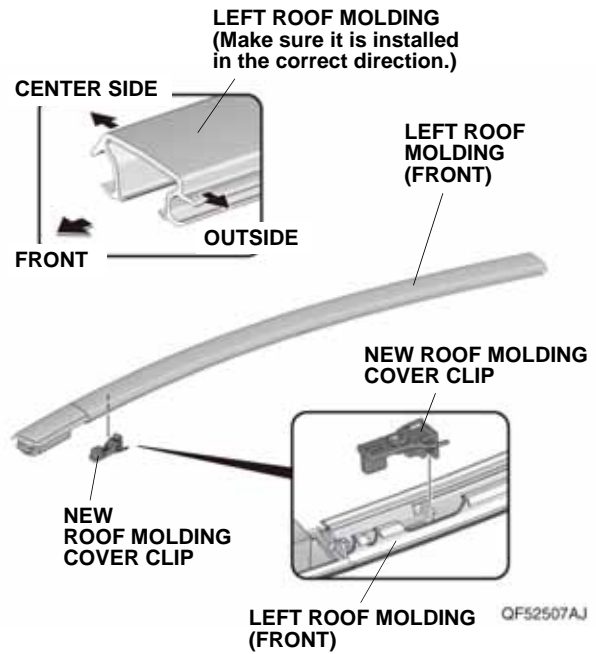

QF52507AJ

8. Install the new molding clip to the left roof molding (rear). Install the spacer to the cut end of the left roof molding (rear).

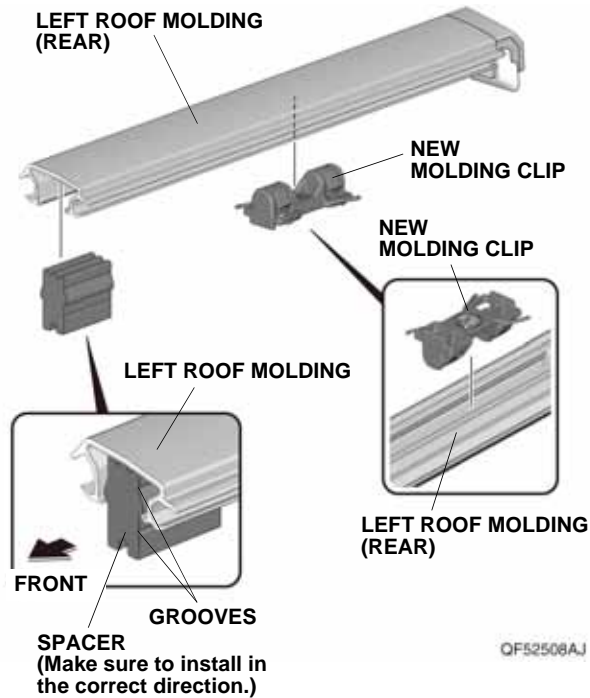

9. Install the left roof moldings back onto the roof of the vehicle as shown.

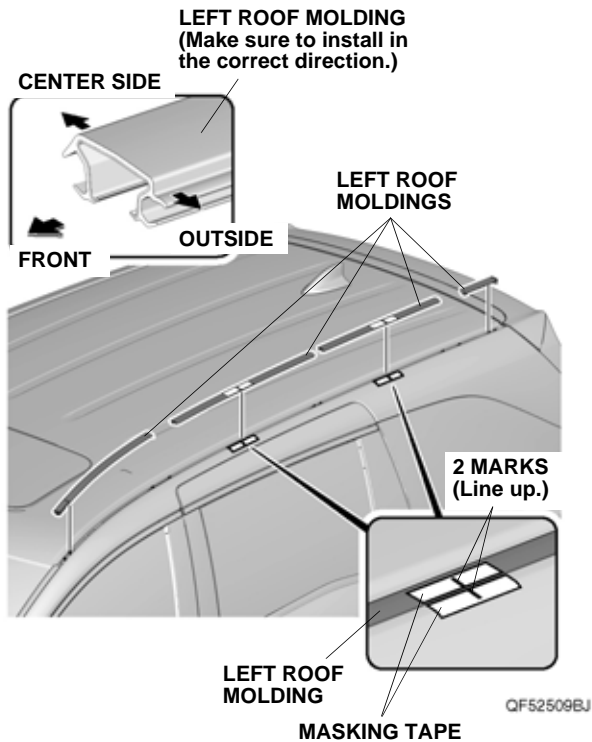

10. Place the left center stay over the two stud bolts at the center, and install two TORX nuts. Torque the TORX nuts to 12 N·m (8.9 lb·ft).

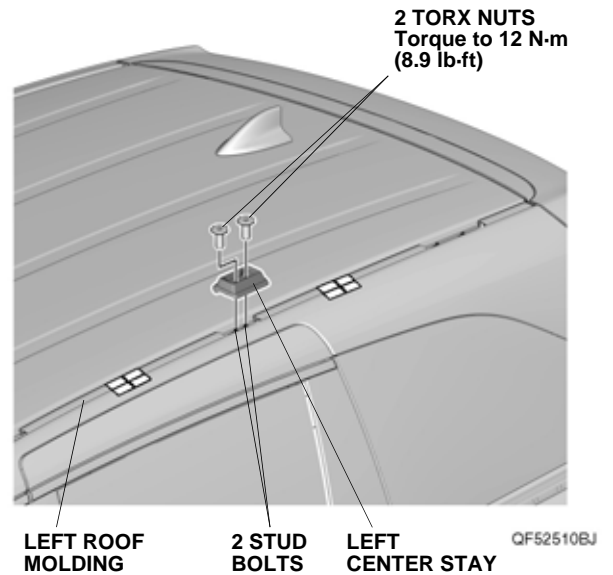

11. Place the left roof rail over the four remaining stud bolts.

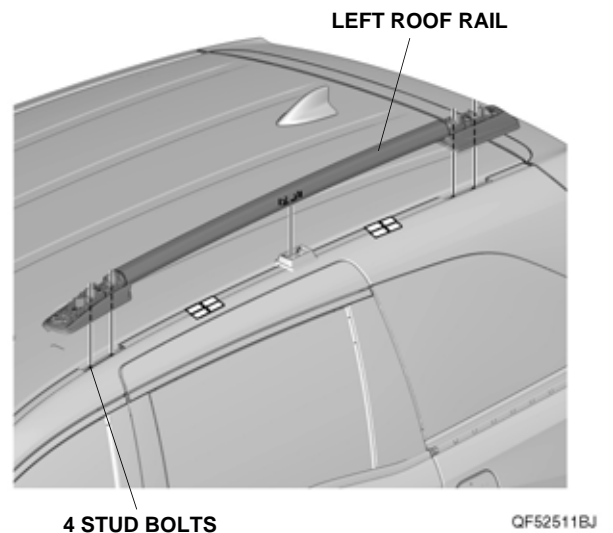

12. Install the four TORX nuts and two TORX bolts. Torque the TORX nuts to 12 N·m (8.9 lb·ft). Install the TORX bolts to 10 N·m (7.4 lb·ft).

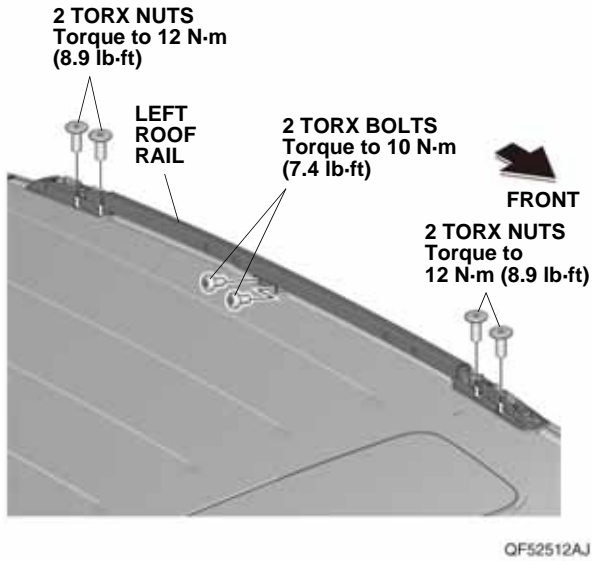

13. Install the two plugs.

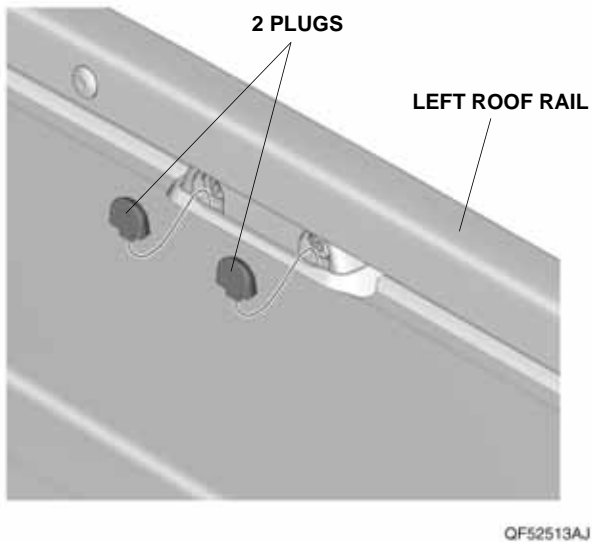

14. Install the left front roof rail cover to the left roof rail with the two clips and one TORX screw.

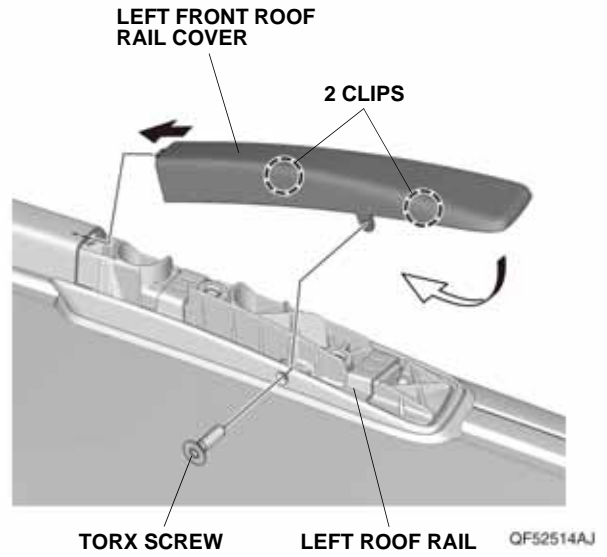

15. Install the left rear roof rail cover to the left roof rail with the two clips and one TORX screw.

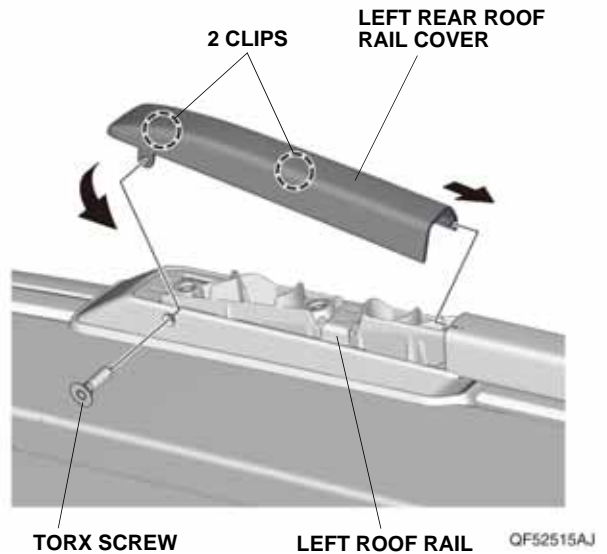

16. Remove the masking tape from the vehicle.
17. Repeat steps 1 through 16 on the right side of the vehicle to install the right roof rail.