



INSTALLATION INSTRUCTIONS

Accessory
DOOR HANDLE PROTECTOR
P/N 08P70-T7S-100

Application
2020 HR-V

Publications No.
VERSION 1
Issue Date
SEP 2019

PARTS LIST

Left door handle protector
(Identification mark: L)



Right door handle protector
(Identification mark: R)



2 Alcohol wipes



TOOLS AND SUPPLIES REQUIRED

Masking tape

Ruler

Illustration of the Door Handle Protector on the Vehicle



INSTALLATION

Customer Information: The information in this installation instruction is intended for use only by skilled technicians who have the proper tools, equipment, and training to correctly and safely add equipment to your vehicle. These procedures should not be attempted by “do-it-yourselfers.”

NOTE:

- Do not damage the body paint finish.
- This kit should be installed only if the ambient air temperature is 15°C (60°F) or above.
- To allow the adhesive to cure, do not wash the vehicle for 24 hours. Make sure the customer is aware of this.

Installing the Door Handle Protector

1. Lock the left front door. Using an alcohol wipe, thoroughly clean the left front door where the left door handle protector will attach.



- Adjust the left door handle protector to fit the door, and temporarily attach it to the left front door with masking tape as shown.
NOTE: Check that the back of the door handle protector has the correct identification mark before installation.

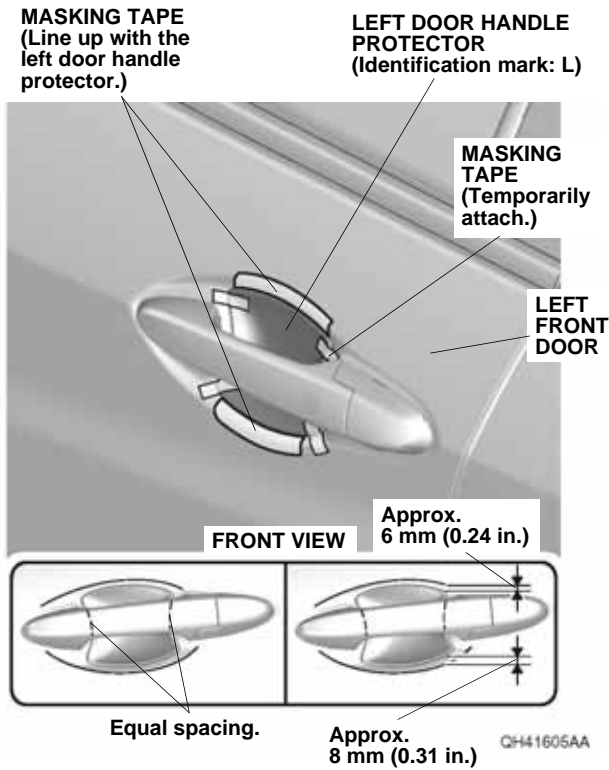

- Attach masking tape to the left front door above and below the left door handle protector as shown. Remove the left door handle protector.

- Peel back the adhesive backings, and tape them to the front surface of the left door handle protector with masking tape as shown.

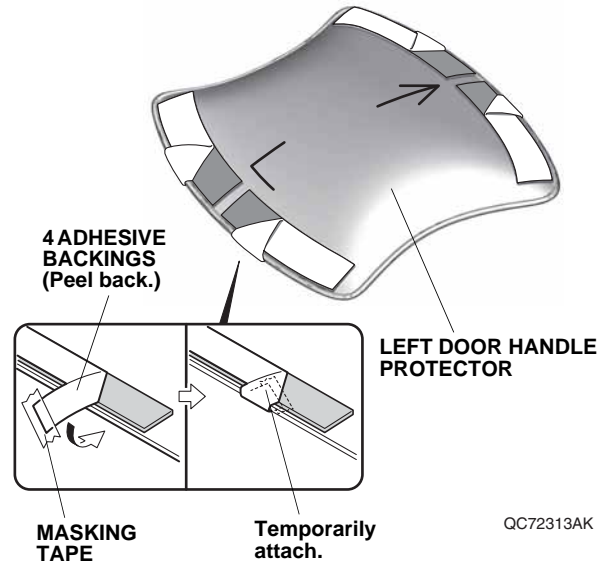

- Line up the left door handle protector with the masking tape attached in step 3, and attach it to the left front door as shown.
NOTE: Check the installation position of the left door handle protector.



6. While applying light pressure against the left door handle protector, carefully remove the taped adhesive backings.

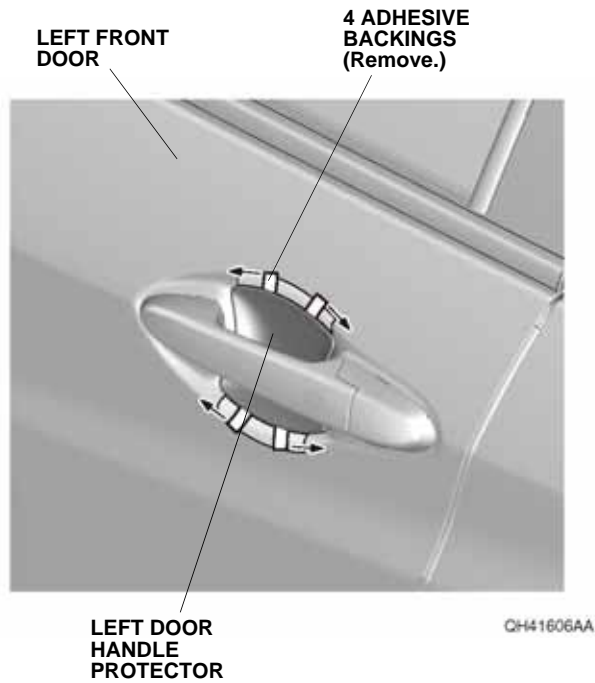

7. Using the palm of your hand, firmly press the left door handle protector against the left front door.
8. Remove the masking tape.
9. Repeat steps 1 through 8 on the right side of the vehicle.