



INSTALLATION INSTRUCTIONS

Accessory	Application	Publications No.
MOONROOF VISOR P/N 08R01-T7S-100	2019 HR-V	VERSION 1
		Issue Date JUL 2018

PARTS LIST

Moonroof visor



2 Brackets A
(Identification mark: T7SA)



2 Brackets B
(Identification mark: T7SB)



4 Screws



4 Nuts



4 Protective tapes



TOOLS AND SUPPLIES REQUIRED

- Phillips screwdriver
- 10 mm offset wrench
- Ruler
- Isopropyl alcohol
- Shop towel
- Masking tape
- Felt-tip pen
- High-quality paste wax

The following tool is available through the Honda Tool and Equipment Program. On the iN, click on: Service > Service Bay > Tool and Equipment Program, then enter the number under "Search." Or, call 888-424-6857.

- Torque Screwdriver (T/N CDI401SM)

INSTALLATION

Customer Information: The information in this installation instruction is intended for use only by skilled technicians who have the proper tools, equipment, and training to correctly and safely add equipment to your vehicle. These procedures should not be attempted by "do-it-yourselfers."

NOTE:

- Be careful not to damage the paint finish.
 - This moonroof visor kit should be installed only if the ambient air temperature is 15°C (60°F) or above.
 - To allow the adhesive to cure, do not wash the vehicle for 24 hours. Make sure your customer is aware of this.
1. Clean and wax the area to be covered with a high-quality paste wax.

2. Open the moonroof. Roll up two shop towels, and insert them between the roof panel and air deflector to lower the air deflector. Be careful not to damage the air deflector.

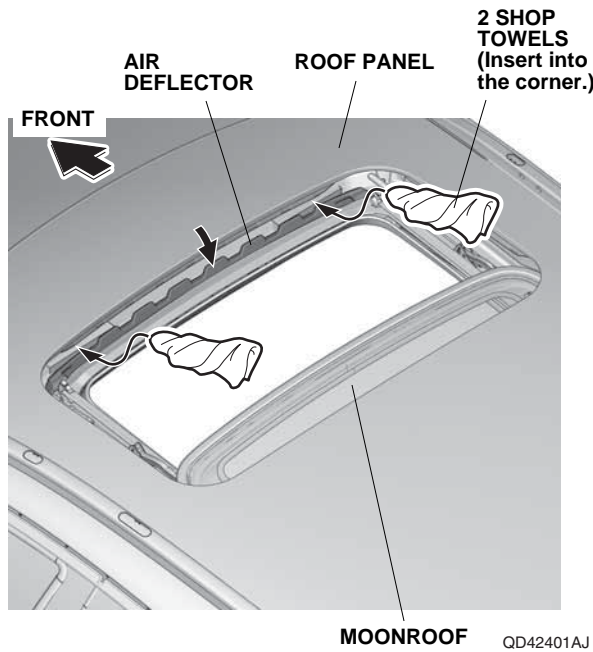

3. Measure and make two marks on the roof panel at the measurements shown.

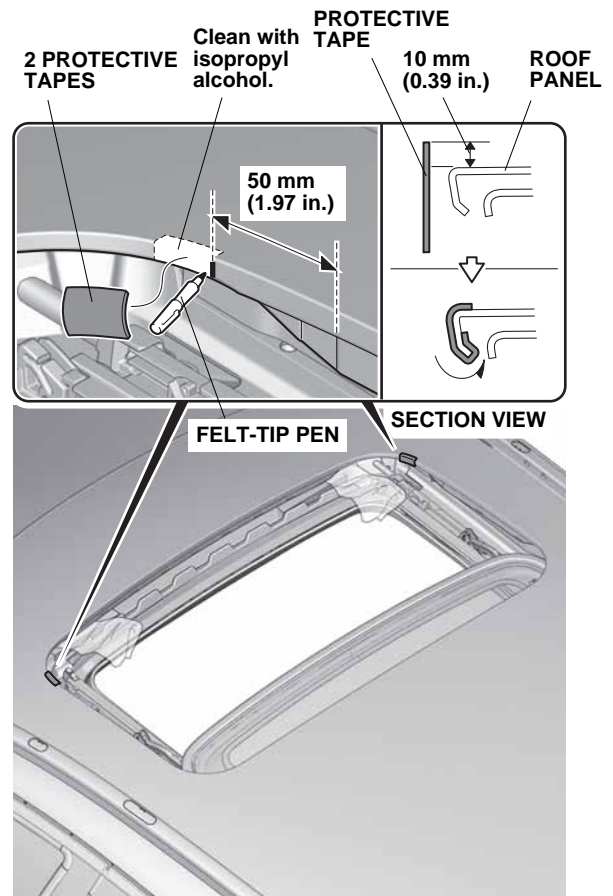

4. Using isopropyl alcohol on a shop towel, clean the roof panel at each of the two marks you have made, but do not wipe off the marks.
5. Remove the adhesive backing from the two pieces of protective tape, and attach them to the roof panel at the two marks you made.

6. Locate the second indentations from the side of the moonroof opening. Using isopropyl alcohol on a shop towel, clean the roof panel where the protective tape will attach.

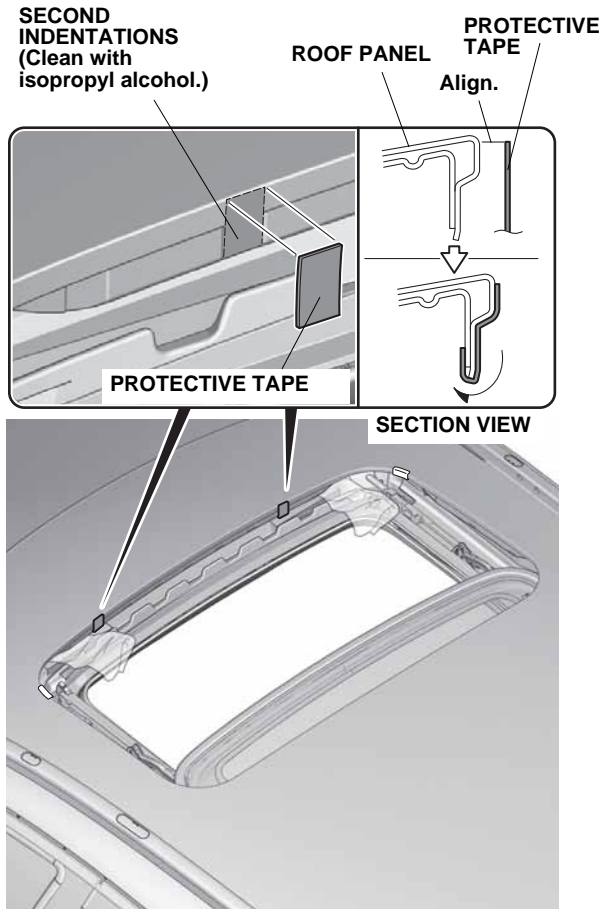

QD42403AJ

7. Remove the adhesive backing from the two pieces of protective tape, and attach them to the roof panel at second indentation.

8. Place two brackets B into position over the two protective tapes and around the lip of the roof panel, and tape them into position with the strips of masking tape.
- NOTE: Be careful not to crease the protective tape.

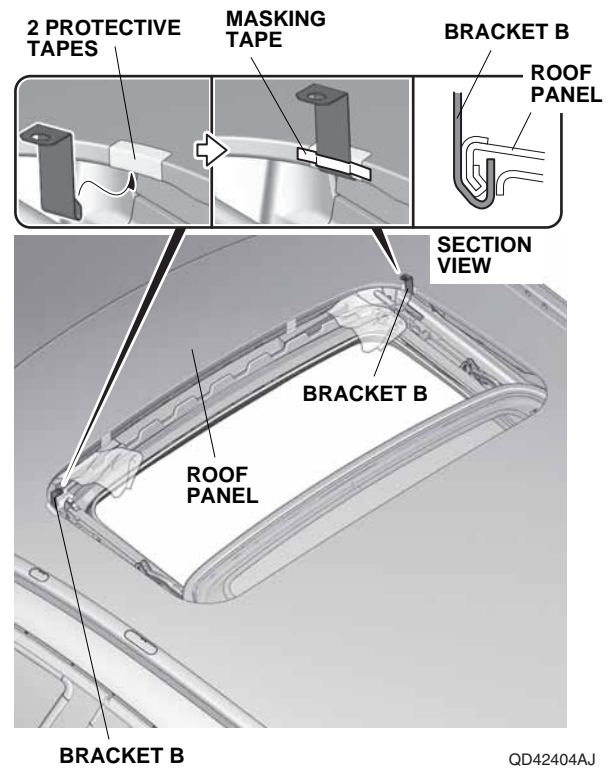

QD42404AJ

9. Place two brackets A into position over the protective tape and around the lip of the roof panel, and tape them into position with the strips of masking tape. Be sure to align the lower end of the brackets A with the second indentation. **NOTE:** Be careful not to crease the protective tape.

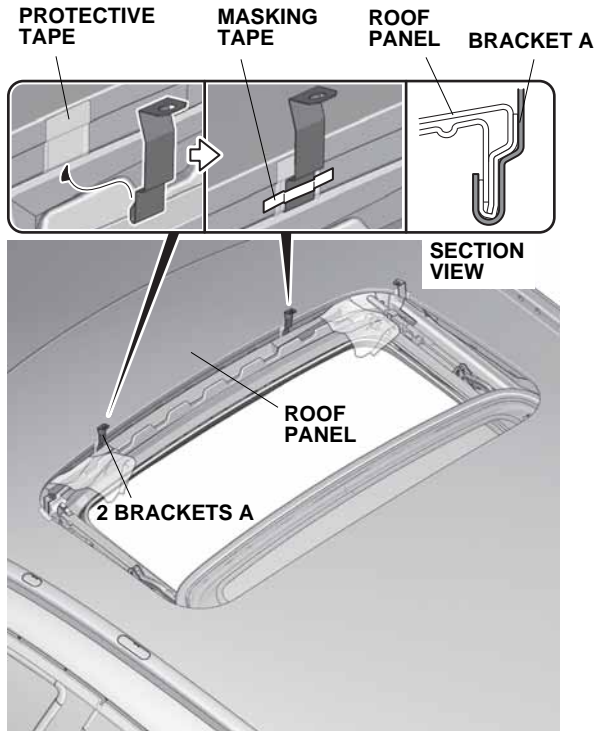

QD42405AJ

10. Set the moonroof visor on the vehicle roof in front of the moonroof opening, and adjust its position so the holes in the moonroof visor are aligned with the bracket A holes. Loosely install the moonroof visor to the brackets A with two screws and two nuts. Remove the strips of masking tape from the brackets A.

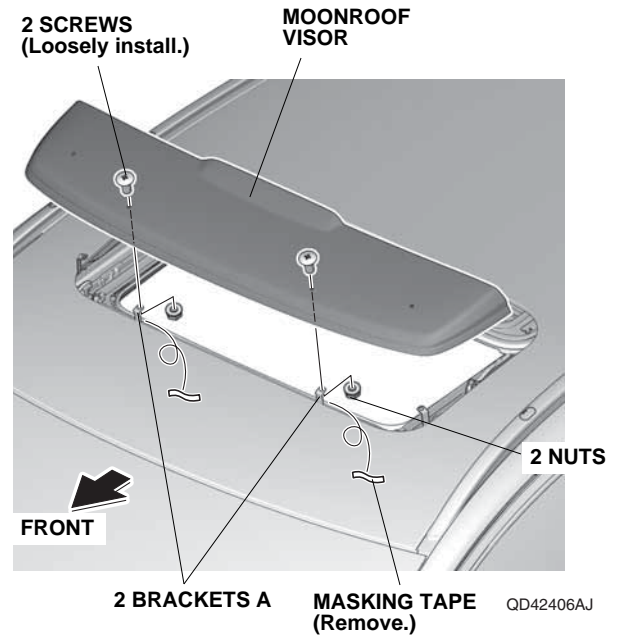

11. Loosely install the moonroof visor to the brackets B with two screws and two nuts. Remove the strips of masking tape from the brackets B.

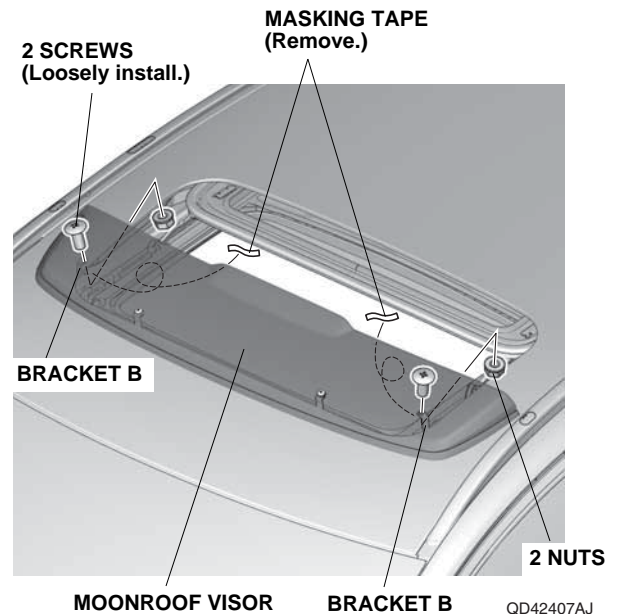

12. Position the moonroof visor with equal spacing in the front and on the sides. Check that the rubber molding is not twisted or rolled under the moonroof visor.

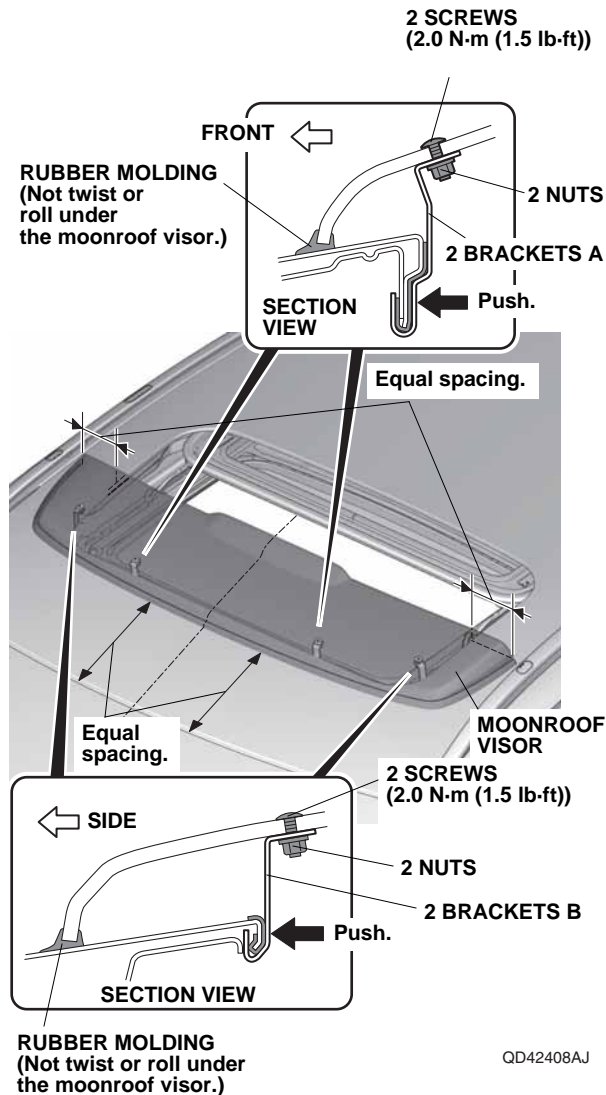

13. Tighten two screws and two nuts on the front of the vehicle first, then tighten two screws and two nuts on each side. Tighten while applying pressure so that there is no gap between the roof panel and the brackets A and B. Torque the screws to 2.0 N-m (1.5 lb-ft).

14. Remove the shop towels inserted in step 2. Remove the IMPORTANT INFORMATION label.

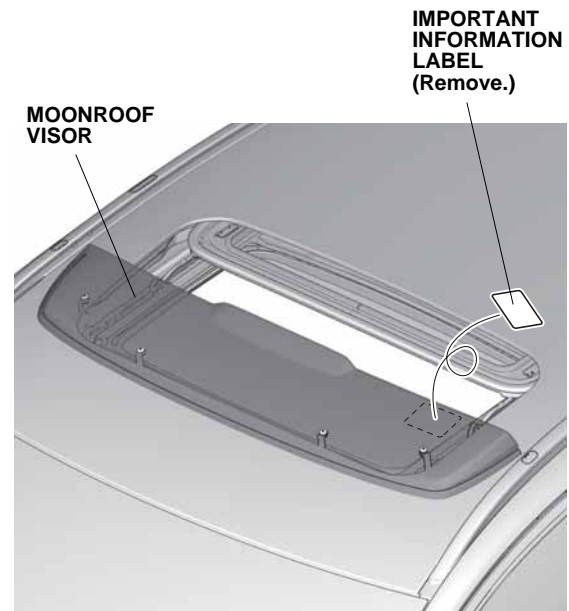

QD42409AJ

CARE OF THE MOONROOF VISOR

- To avoid damaging the surface, do not use organic solvents such as gasoline, ammonia-based cleaners, or solvents to clean the moonroof visor.
- Clean with neutral detergent solution and water using a soft cloth or chamois.
- To remove fine scratches and restore the original luster, use Meguiar's Mirror Glaze plastic cleaner and polish or an equivalent high-quality plastic cleaner.