



INSTALLATION INSTRUCTIONS

| Accessory | Application | Publications No. |
|---------------------------------|-------------|------------------------|
| CARGO TRAY P/N 08U45-T7S-100 | 2019 HR-V | VERSION 1 |
| | | Issue Date JUL 2018 |

PARTS LIST

Cargo tray



TOOLS AND SUPPLIES REQUIRED

Utility knife

File

Illustration of the Cargo Tray in the Vehicle



QD40801AK

INSTALLATION

If the vehicle is 2WD model, continue with step 1. If the vehicle is 4WD model without cargo net, go to step 3. If the vehicle is 4WD model with cargo net, go to step 4.

2WD Models

- Using a utility knife, cut out the cargo tray as shown. Remove any burrs.

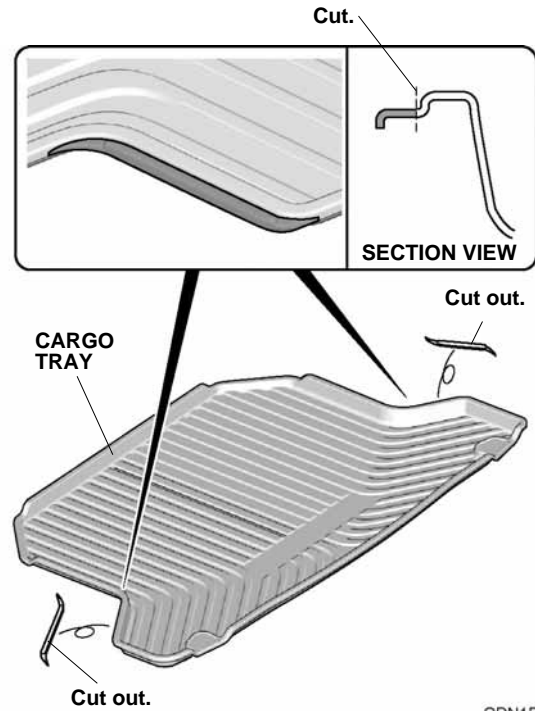

QDN1501BT

2. Open the tailgate. Place the cargo tray on the cargo floor.

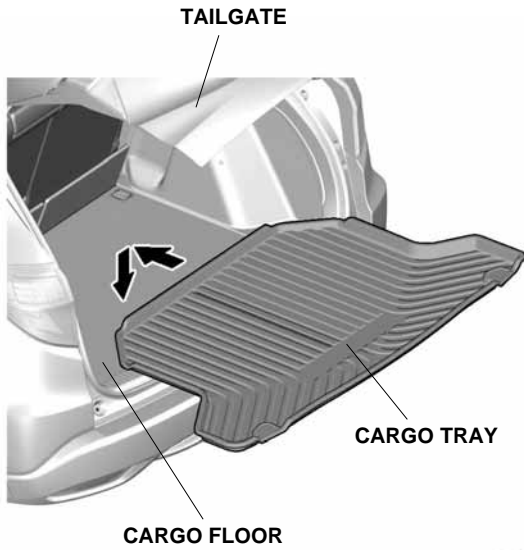

QDN1502AT

4WD Models Without Cargo Net

3. Open the tailgate. Place the cargo tray on the cargo floor.

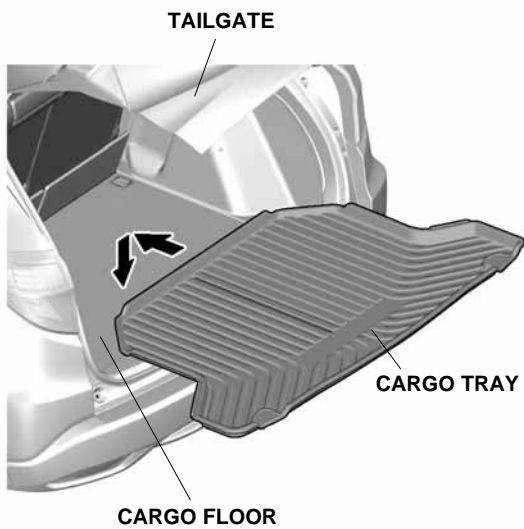

QD40802BK

4WD Models With Cargo Net

4. Using a utility knife, cut out the cargo tray as shown. Remove any burrs.

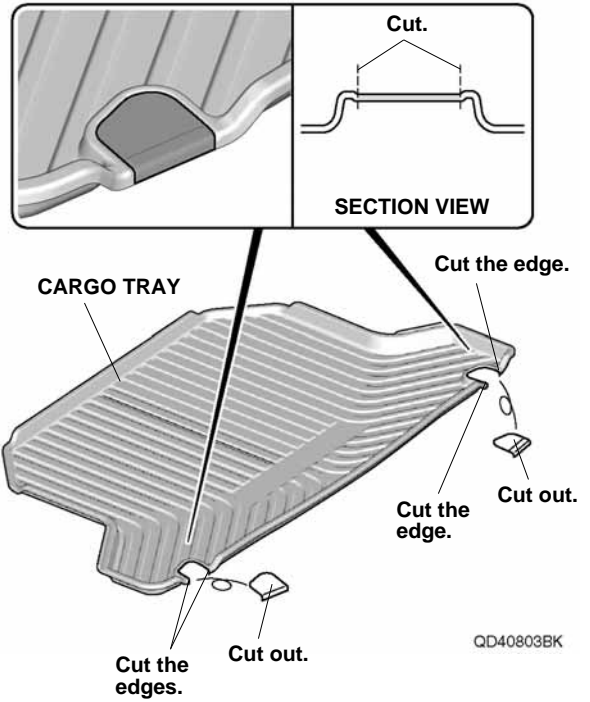

QD40803BK

5. Open the tailgate. Place the cargo tray on the cargo floor.

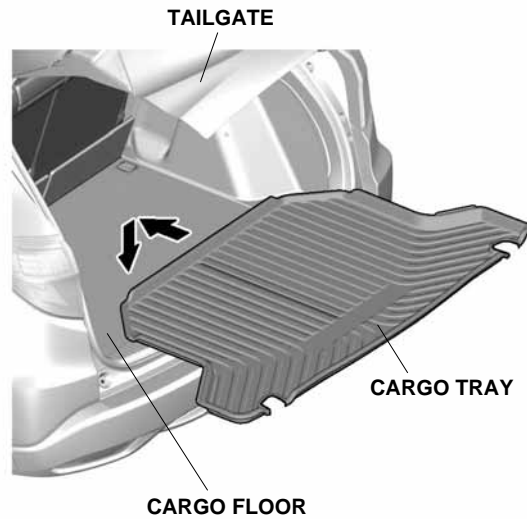

QD40804BK