



**INSTALLATION
INSTRUCTIONS**

Accessory
FLOOR MATS

Application
2009 FIT

Publications No.
All 39830
Issue Date
AUG 2008

PARTS LIST

Driver's side front floor mat

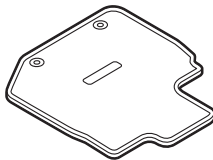

Passenger's side front floor mat

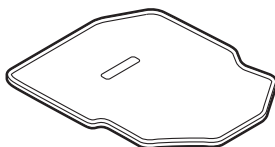

Left rear floor mat

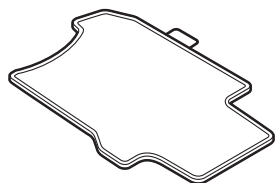

Right rear floor mat

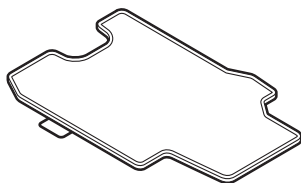

2 Anchors

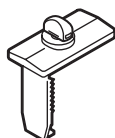

TOOLS AND SUPPLIES REQUIRED

Utility knife

Scale

Clip remover (or flat-tip screwdriver)

INSTALLATION

NOTE:

- Before installing the floor mats, identify their installation locations.
- Anchors are required for the driver's side of the vehicle; they prevent the front floor mat from sliding forward and interfering with the pedals.
- If you remove the driver's side front floor mat, make sure you reanchor it when you put it back in the vehicle.

- If you replace the floor mats, use factory mats designed to be used with the anchors.
- Do not put additional mats on top of the anchored mat. The additional mats may slide forward and interfere with the pedals.

1. Slide the driver's seat all the way back.
2. Locate the two slit marks on the rubber mat. Using a utility knife, cut back to the edge of the rubber mat and remove the rectangular piece of rubber mat.

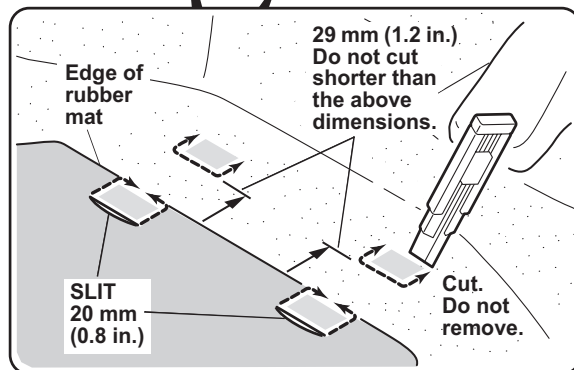
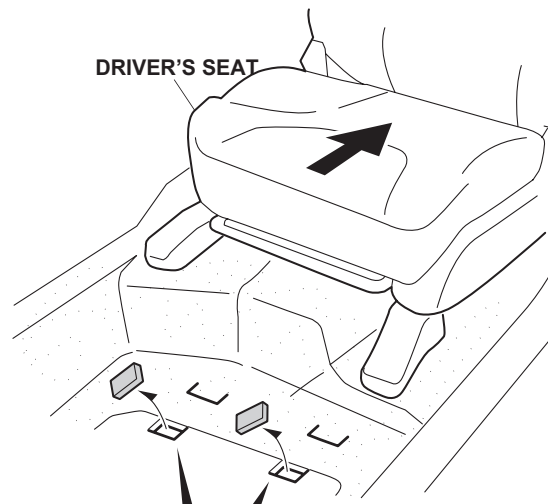

3. Locate the two recesses in the carpet. Using a utility knife, slit the carpet at the front of the recess. Do not cut out the piece between the recess and the rubber mat.

- Lift the floor carpet to create a space to insert the anchor between the floor carpet and insulator.

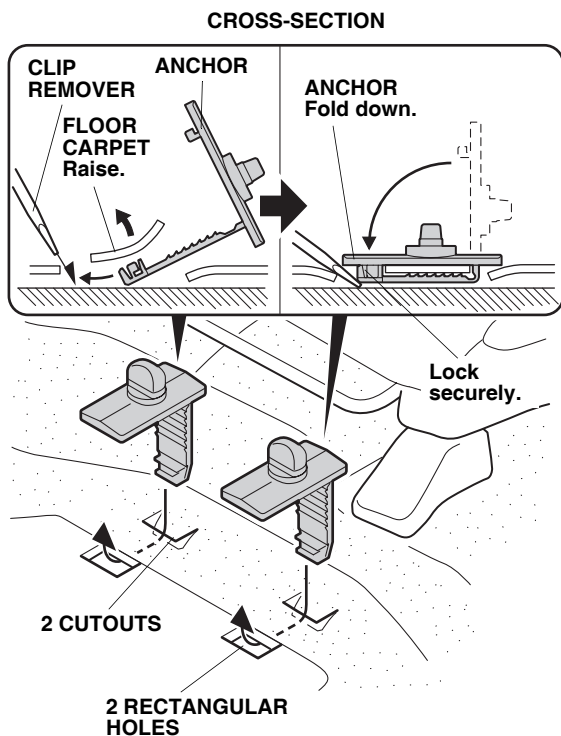

- Insert the two anchors into the two cutouts and move the lock tabs forward into the rectangular holes. If necessary, use a clip remover or equivalent tool to open the hole in the floor carpet.
- Fold the anchors down to lock them in place. Make sure the floor carpet is not caught in the anchors. Confirm that each anchor is locked securely.

- Place the driver's side front floor mat over the anchors as shown.

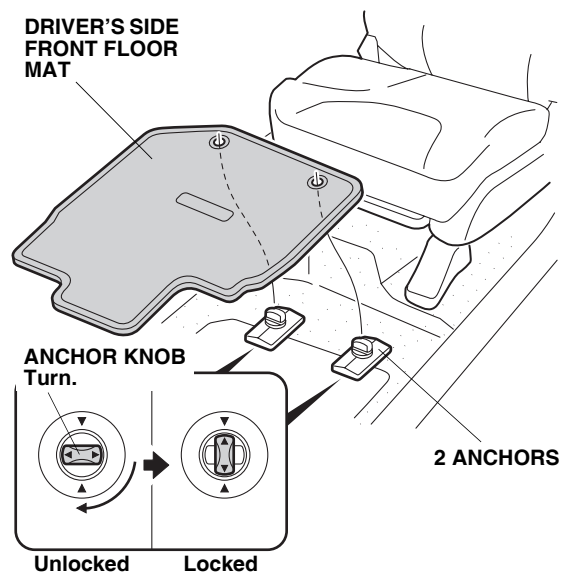

- Turn the knobs on the two anchors to secure the driver's side front floor mat.
- Install the passenger's side front floor mat.

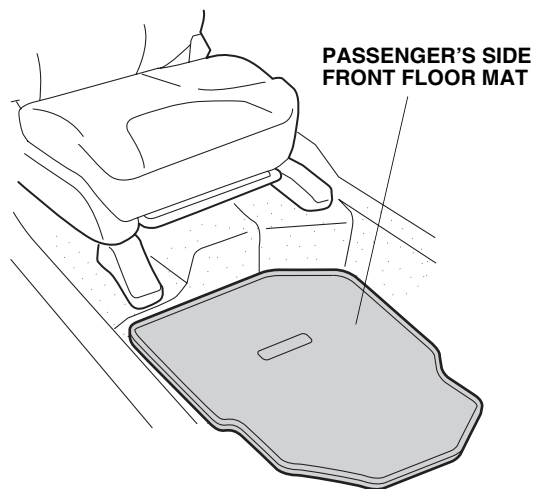

10. Install the right and left rear floor mats.

