



INSTALLATION INSTRUCTIONS

Accessory
ROOF RAILS
 P/N 08L02-TLA-100

Application
2020 CR-V

Publications No.
VERSION 1
 Issue Date
OCT 2019

PARTS LIST

Left roof rail



Right roof rail



4 Caps A



4 Caps B



12 TORX nuts



TOOLS AND SUPPLIES REQUIRED

Flat-tip screwdriver

T-30 TORX bit

Eye protection (face shield, safety goggles, etc.)

File

Felt-tip pen

Blanket

Approx. 120 mm height empty cardboard box

Torque wrench

Ruler

Tape

The following tools are available through the Honda Tool and Equipment Program. On the iN, click on Service > Service Bay > Tool and Equipment Program, then enter the number under "Search." Or, call 888-424-6857.

- Trim Tool Set (T/N SOJATP2014)
- Plastic Trim Tool (T/N SILTRIMTL10)
- Air Saw (T/N AT192A)

Illustration of the Roof Rails on the Vehicle

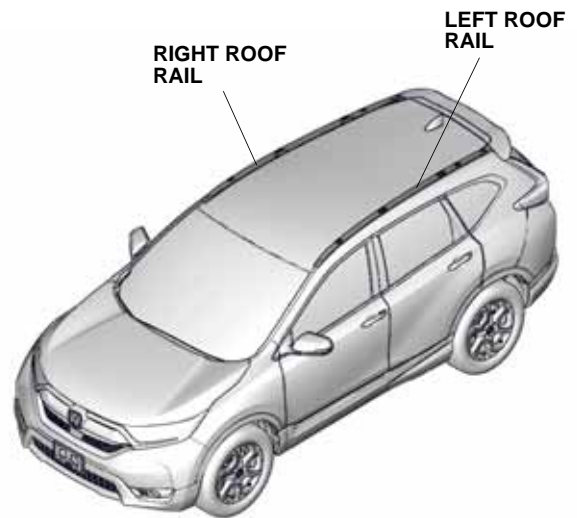

QF20301AN

INSTALLATION

Customer Information: The information in this installation instruction is intended for use only by skilled technicians who have the proper tools, equipment, and training to correctly and safely add equipment to your vehicle. These procedures should not be attempted by “do-it-yourselfers.”

NOTE:

- Be extremely careful not to damage the roof and other finished surfaces of the body when installing the roof rails.
- The weight of the cargo must not exceed the maximum weight capacity of 75 kg (165 lbs).

Installing the Roof Rails

1. Measure rearward from the windshield molding, and mark the left roof molding as shown.

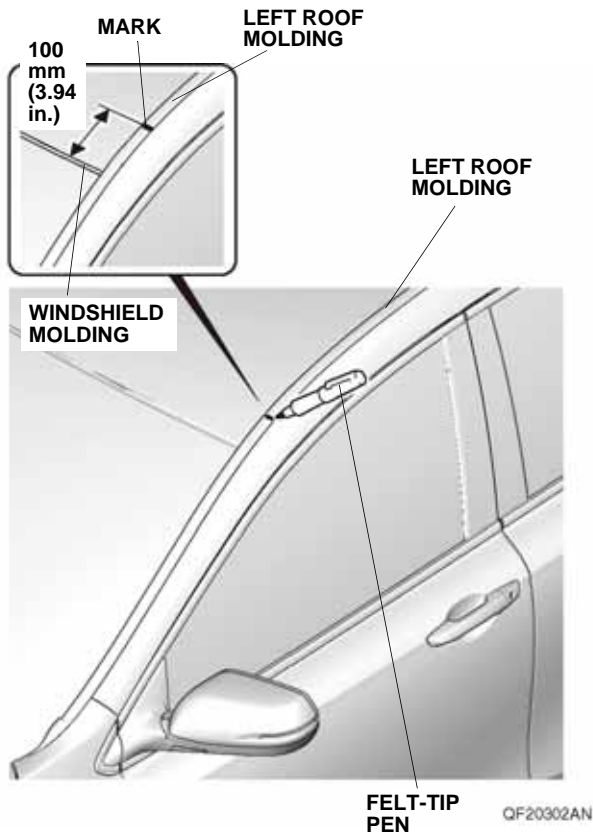

2. Using a plastic trim tool, pry up on the left roof molding cover to release one retaining tab.

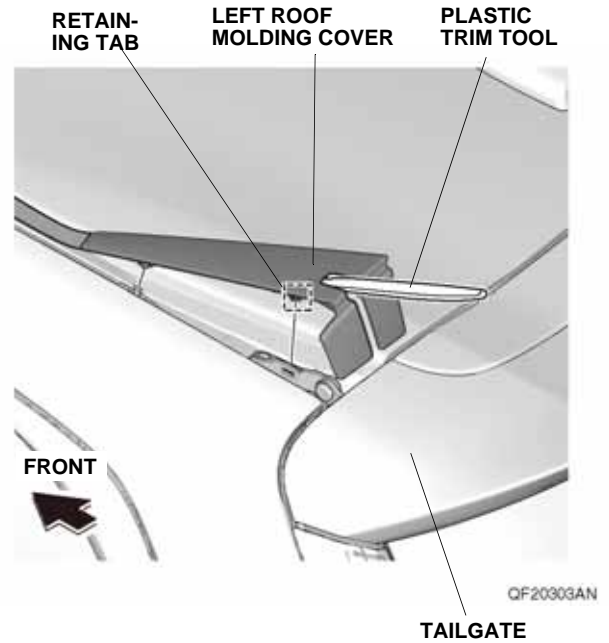

3. Pull the left roof molding toward the outside of the vehicle to release the locking tabs, and then press the locking tabs toward the inside of the vehicle, and release the left roof molding from the vehicle. When releasing the left roof molding, start from the rear of the vehicle and work toward the front.

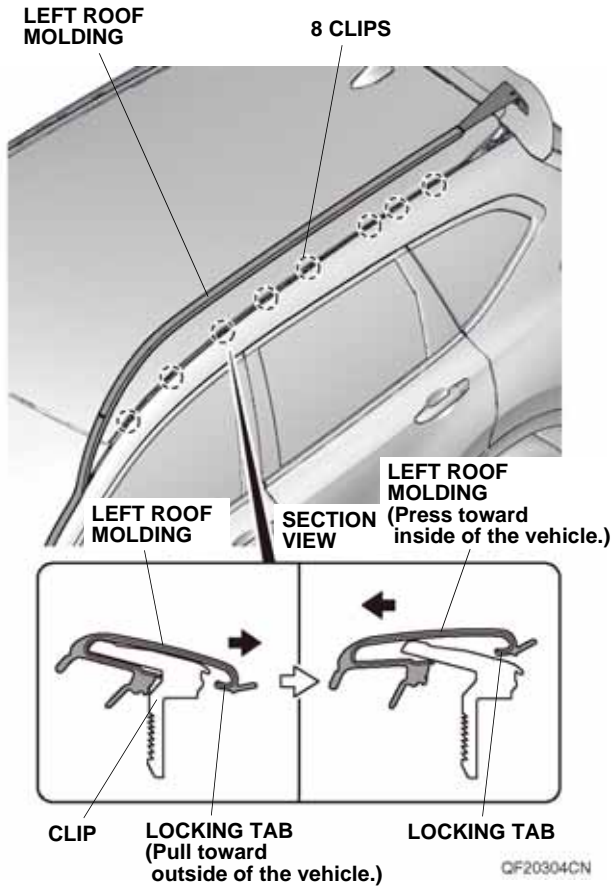

4. While pulling up the left roof molding, remove two clips. Insert a plastic trim tool alternately to each slot in the clip, and release the locking tabs in the order shown. When releasing the left roof molding, start from the rear of vehicle and work toward the front. Be careful not to deform the roof molding.

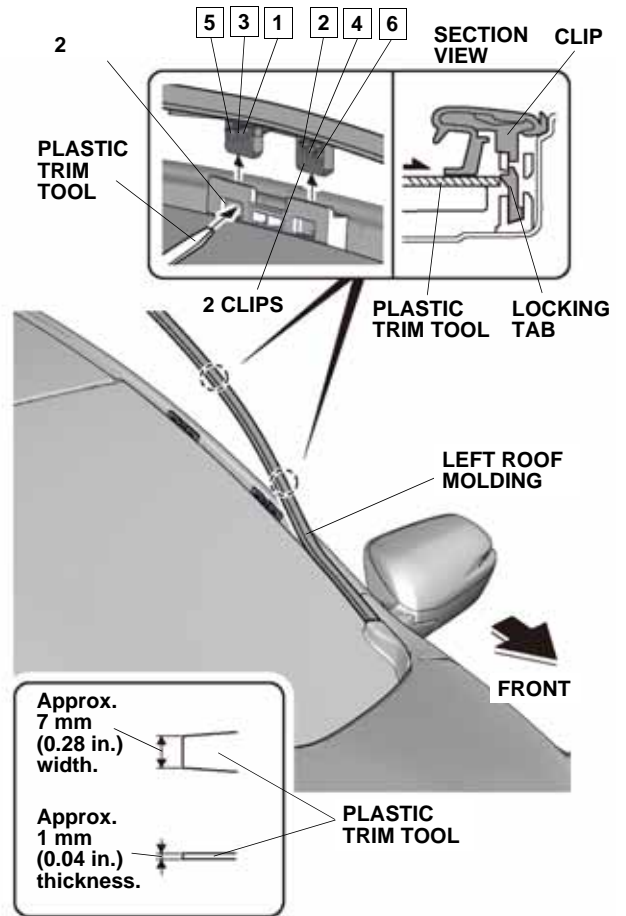

5. Place a blanket over the roof under the left roof molding. Be careful not to deform the roof molding when measuring and cutting.

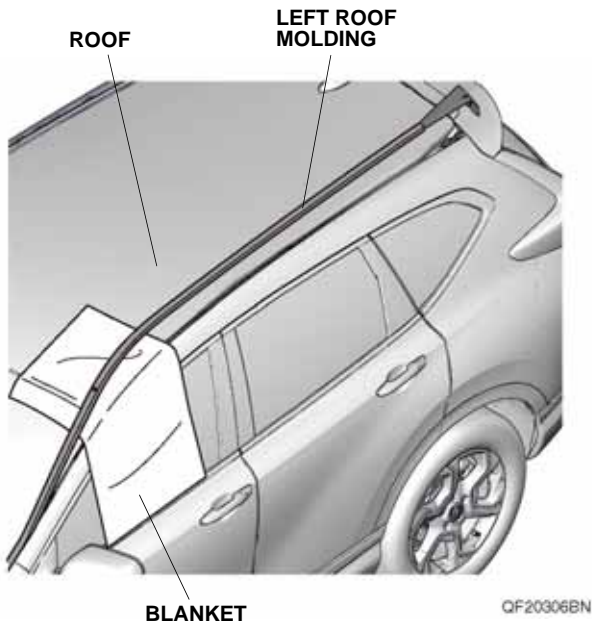

6. Place an empty cardboard box (approx. 120 mm height) under the left roof molding near the mark.

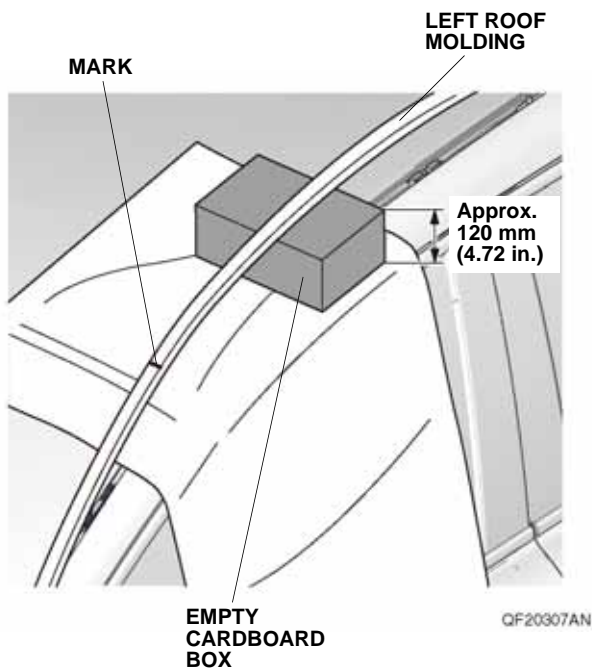

7. While wearing eye protection, use an air saw to cut the left roof molding at the mark. Do not use a cutting wheel or shears to cut the left roof molding; that can damage the left roof molding. With the help of an assistant, hold the rear edge while cutting. Remove any burrs.

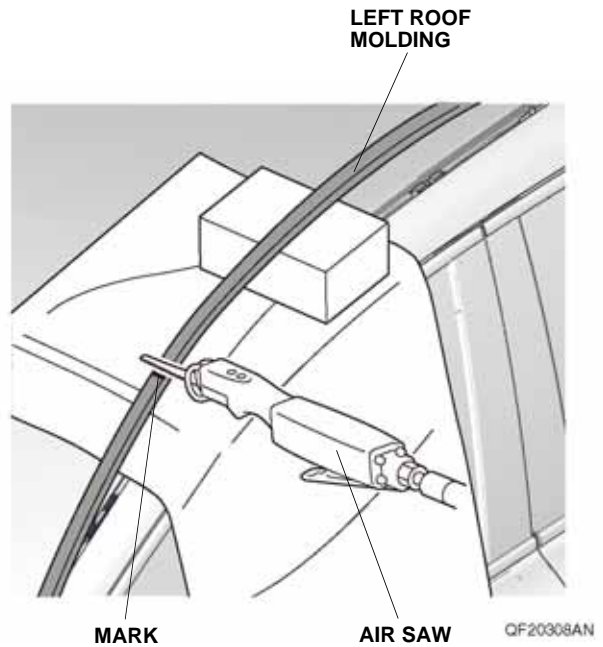

8. Remove the cardboard box and blanket.
9. Secure the two clips removed in step 4.

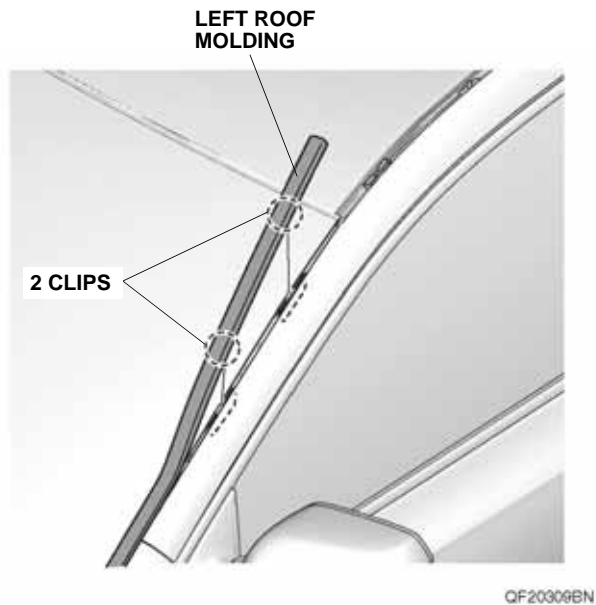

10. Insert two flat-tip screwdrivers alternately between four clips and four stud bolts as shown. While pulling on the clips, release the locking tabs on the clips from the groove on the stud bolts notch by notch, and remove the clips.

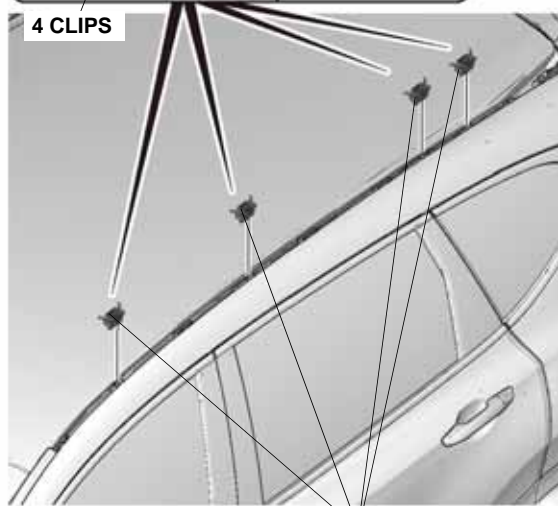
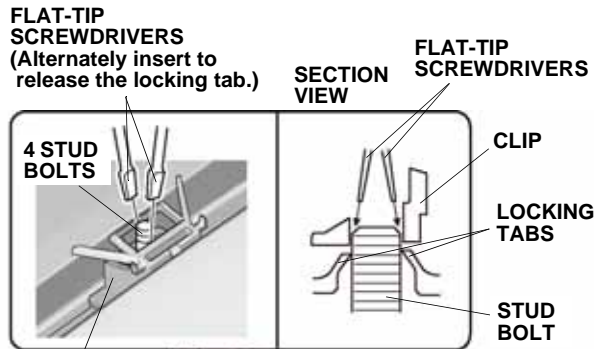

4 CLIPS (Discard.) QF20310AN

11. Remove four clips from the roof.

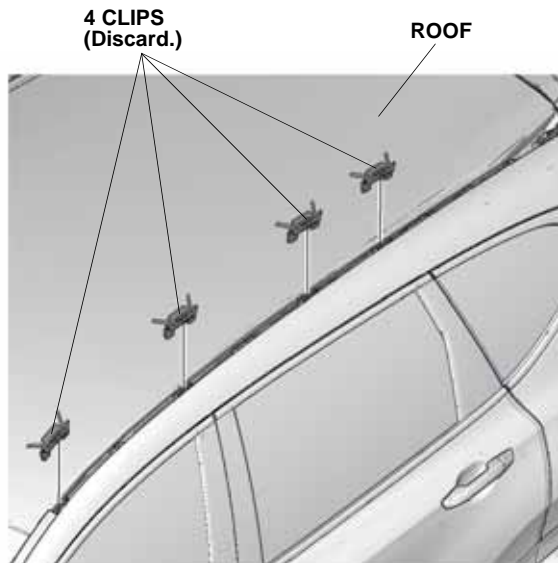

QF20311AN

12. Using a flat-tip screwdriver wrapped with tape, remove the left roof molding cover from the left roof molding. Do not reuse the left roof molding.

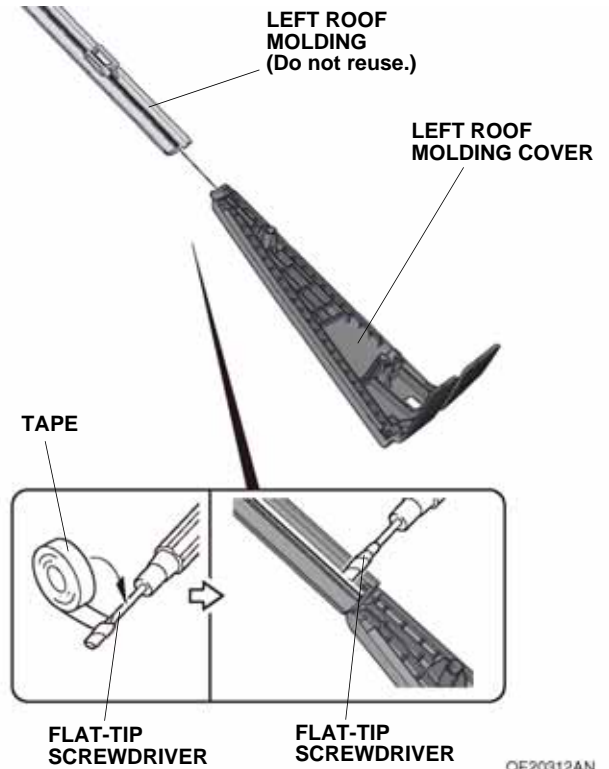

QF20312AN

13. Install the left roof molding cover in its original position on the roof with one retaining tab.

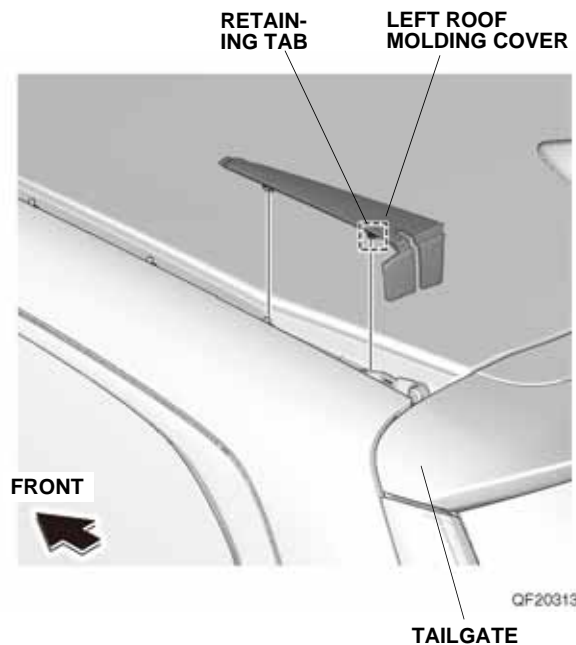

QF20313AN

14. Install the left roof rail to the vehicle with six TORX nuts. Torque the six TORX nuts to 10 N·m (7.4 lb·ft).

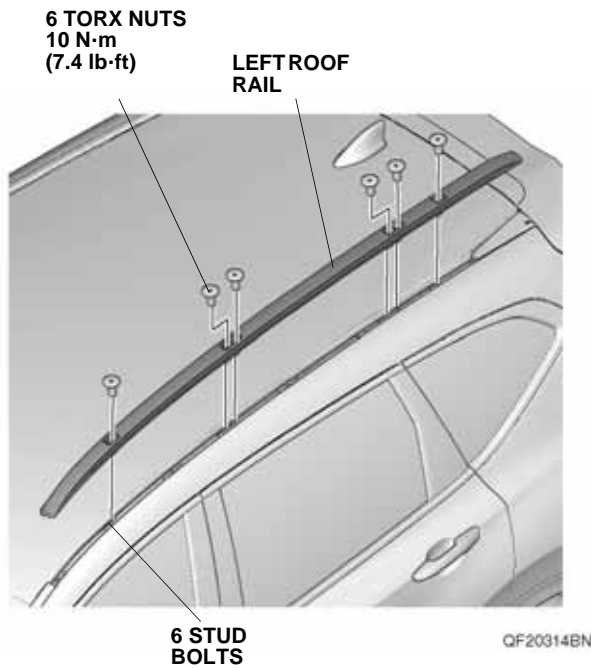

15. Install each cap A and each cap B to the left roof rail with three retaining tabs.

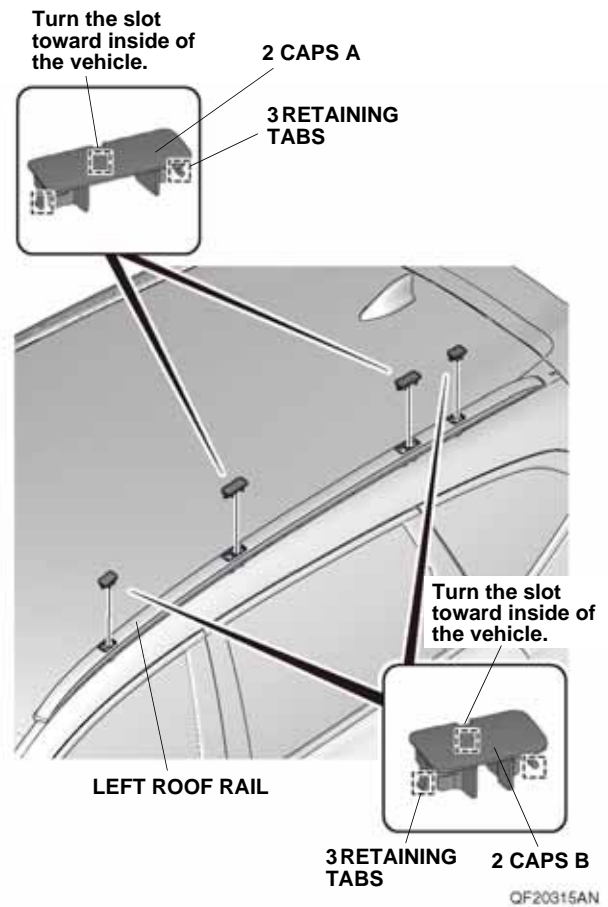

16. Repeat steps 1 through 15 on the right side of the vehicle.

USE AND CARE

Check the roof rail mounting bolts frequently, and retighten if necessary.