



INSTALLATION INSTRUCTIONS

Accessory
REAR SEAT COVERS
 P/N 08P32-TLA-100

Application
2020 CR-V

Publications No.
VERSION 1
 Issue Date
OCT 2019

PARTS LIST

Rear seat covers

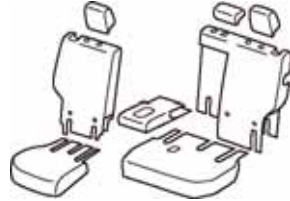
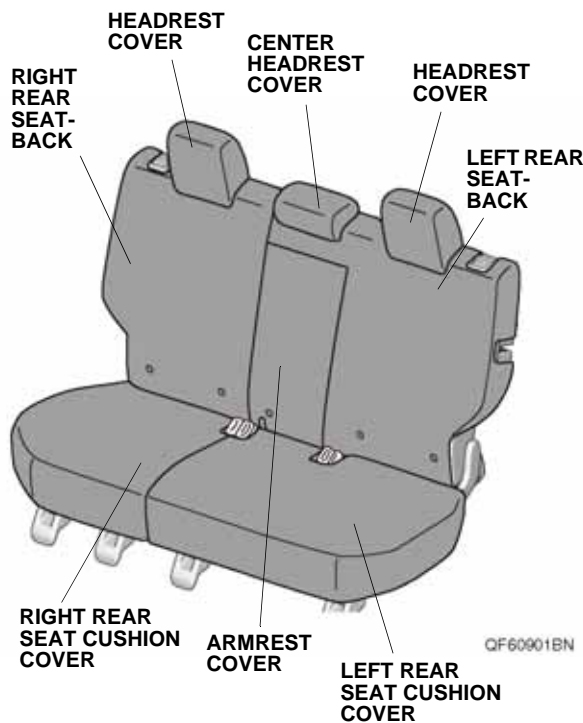

Illustration of the Rear Seat Covers in the Vehicle



INSTALLATION

NOTE:

- Do not damage the vehicle during installation.
 - Do not install the seat covers to the front seat. Improperly covering the front seat may prevent the side airbag from inflating during a side impact.
 - Identify each seat cover by the tags on the back.
1. While pressing on each headrest guide knob, remove the two headrests and the center headrest by pulling them upward.

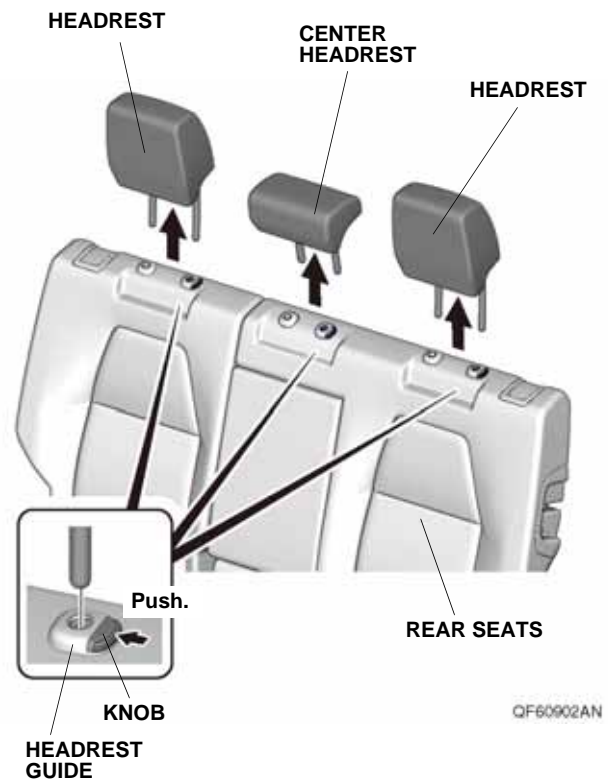

2. Fit two headrest covers and the center headrest cover over the headrests.

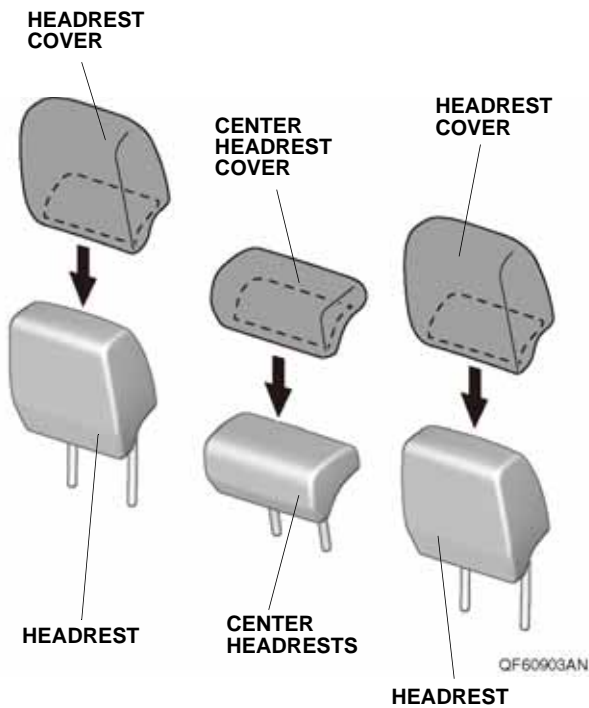

3. Fit the right rear seat-back cover onto the right rear seat-back. Insert the right rear seat-back cover under each headrest guide.

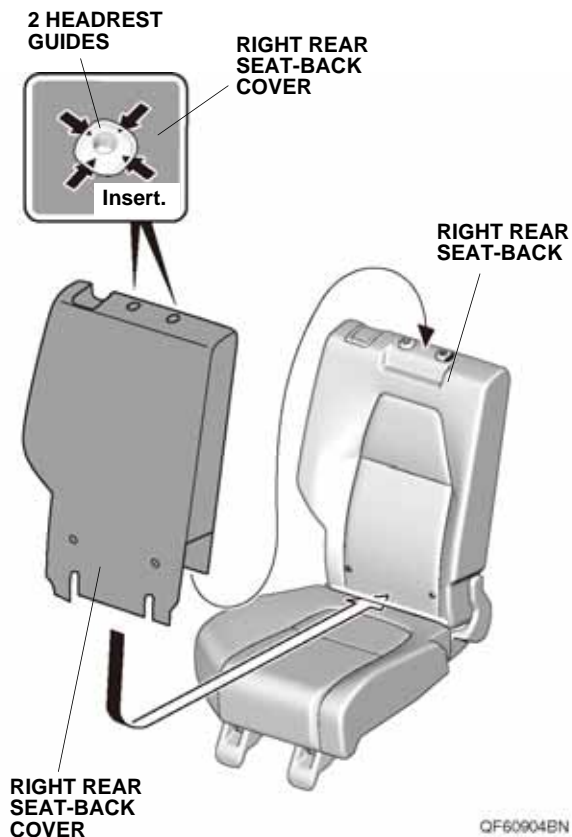

4. Secure the right rear seat-back cover to the right rear seat-back with three fasteners.

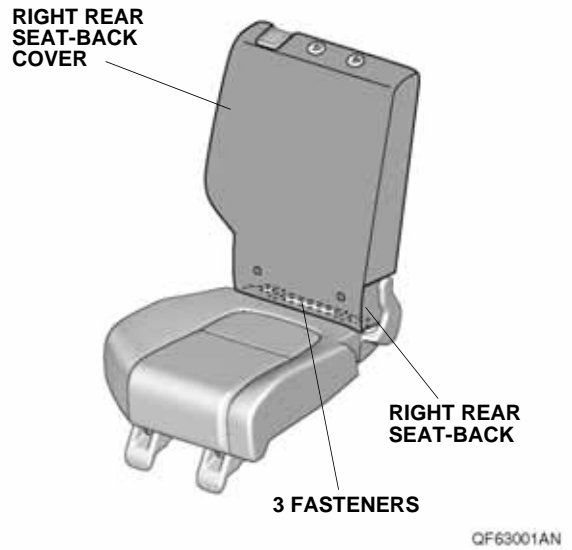

5. Fold down the right rear seat-back, and raise the cargo floor lid as shown. Secure the right rear seat-back cover to the right rear seat-back with four fasteners.

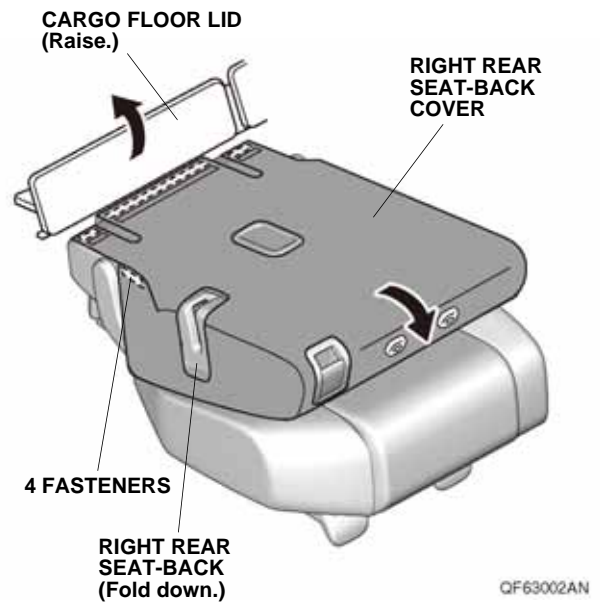

6. Raise the right rear seat-back. Fit the right rear seat cushion cover onto the right rear seat cushion.

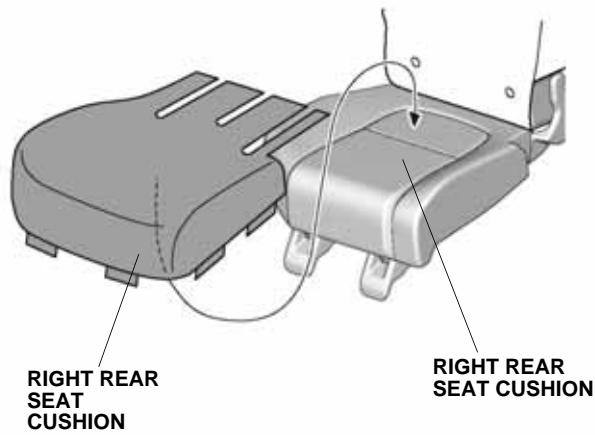

QF60906BN

7. Secure the right rear seat cushion cover into the right rear seat cushion with six fasteners.

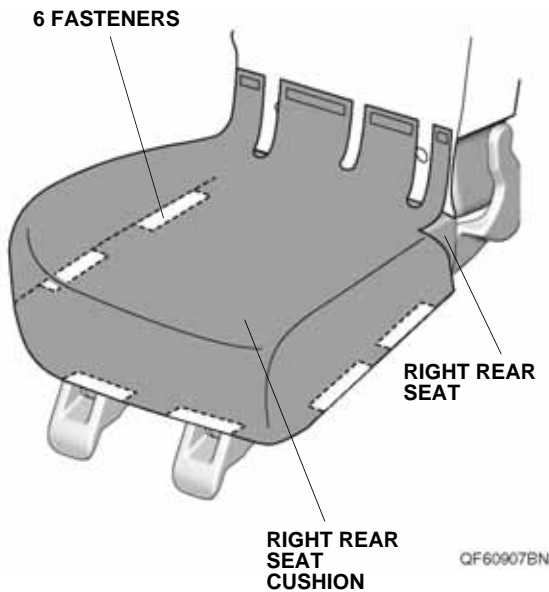

QF60907BN

8. Half fold down the right rear seat-back, and raise the cargo floor lid as shown. Insert the right rear seat cushion cover between the right rear seat-back and right rear seat cushion, and pull out the right rear seat cushion cover behind the right rear seat-back.

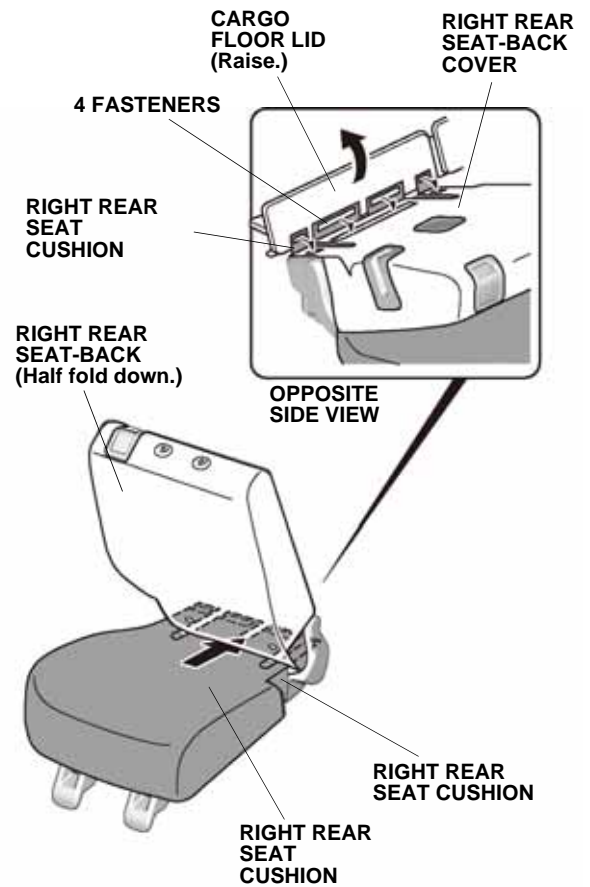

QF63003AN

9. Secure the right rear seat cushion cover to the right rear seat-back cover with four fasteners as shown.
10. Raise the right rear seat-back.

11. Pull down the armrest. Fit the left rear seat-back cover onto the left rear seat-back. Insert the left rear seat-back cover under each headrest guide.

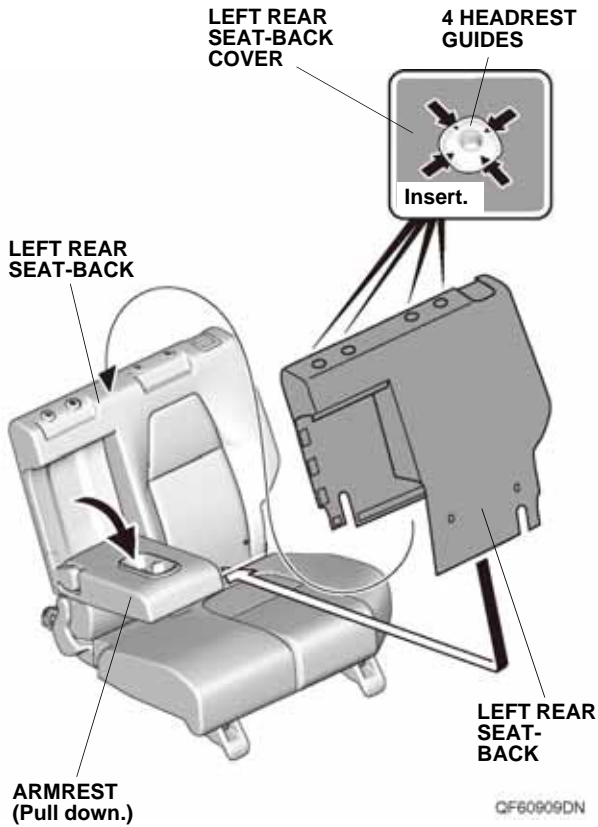

12. Insert the tab to the left rear seat-back. Secure the left rear seat-back cover to the left rear seat-back with two fasteners.

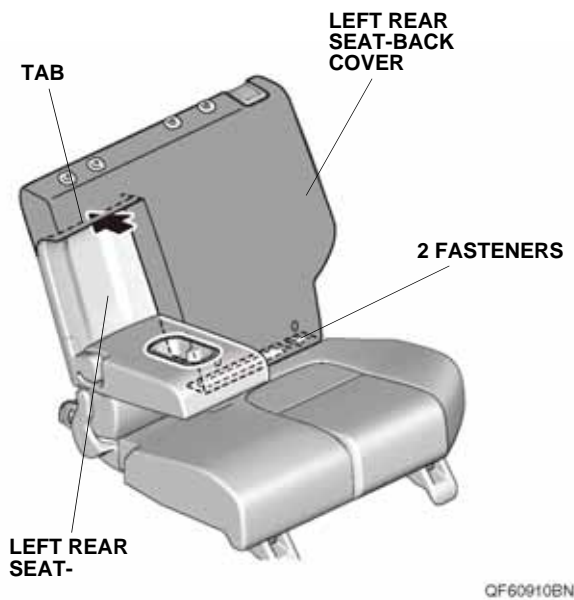

13. Fit the armrest cover onto the armrest.

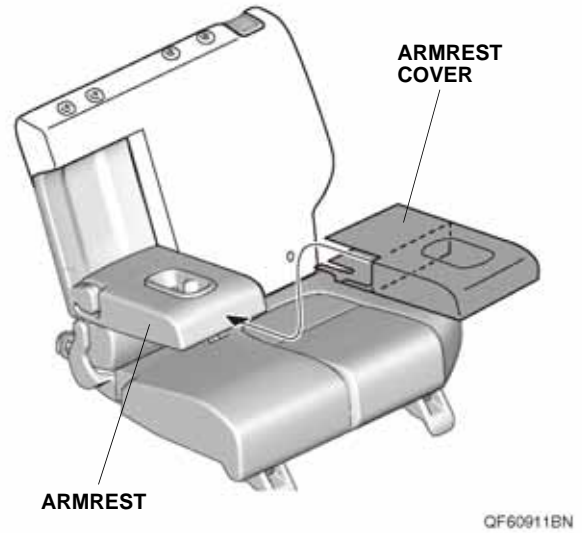

14. Raise the armrest. Pull out the armrest cover between the armrest and left rear seat-back. Secure the armrest cover with four fasteners as shown.

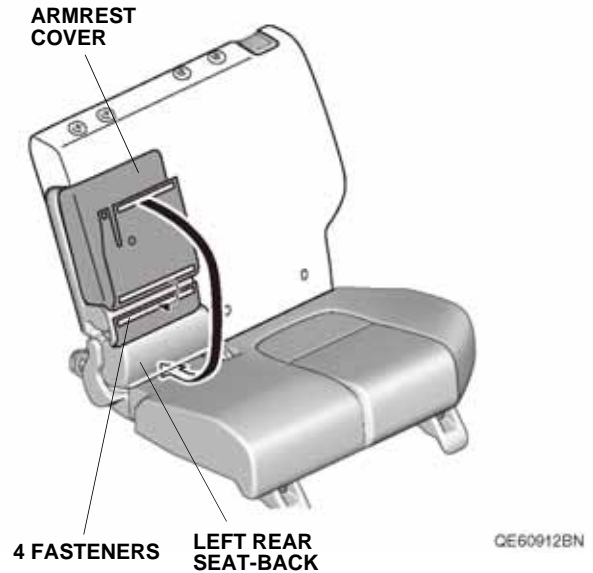

15. Fold down the left rear seat-back, and raise the cargo floor lid as shown. Secure the left rear seat-back cover to the left rear seat-back with seven fasteners.

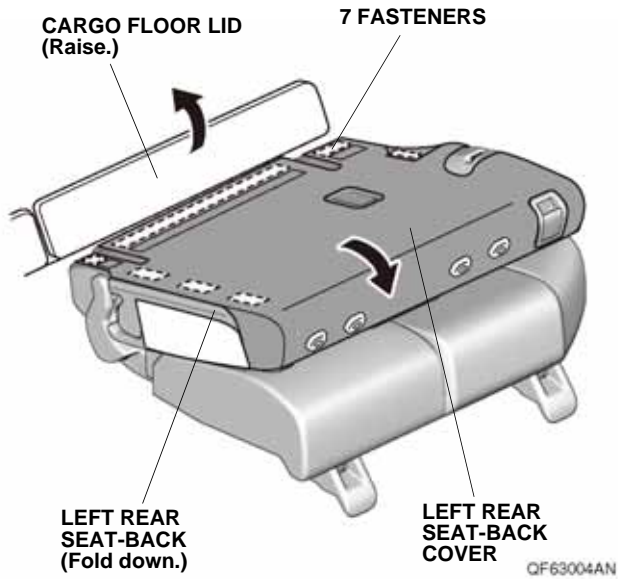

16. Raise the left rear seat-back. Fit the left rear seat cushion cover onto the left rear seat cushion.

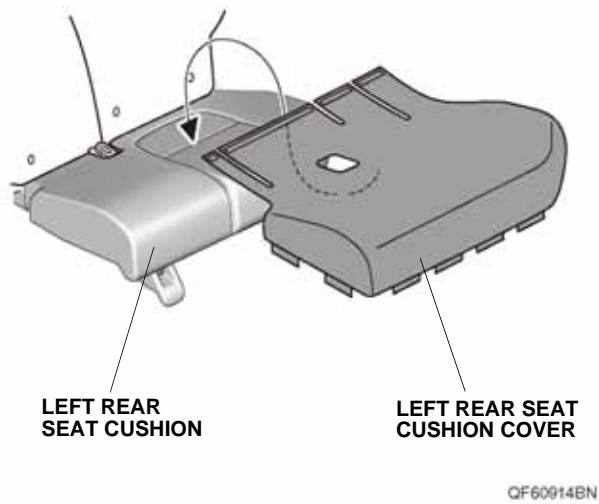

17. Secure the left rear seat cushion cover to the left rear seat cushion with eight fasteners.

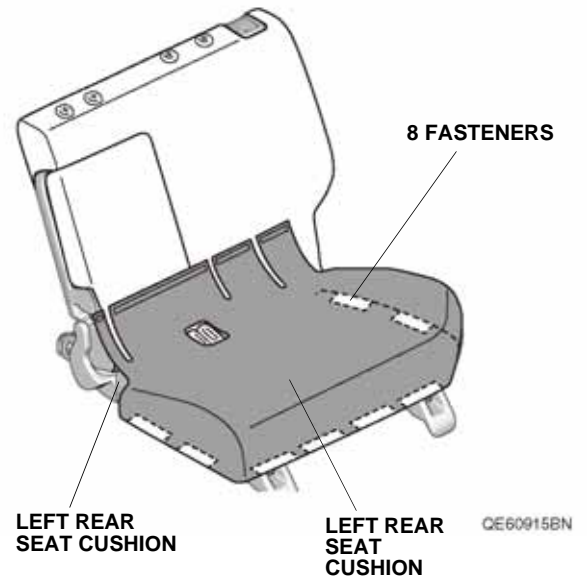

18. Half fold down the left rear seat-back, and raise the cargo floor lid as shown. Insert the left rear seat cushion cover between the left rear seat-back and left rear seat cushion, and pull out the left rear seat cushion cover behind the left rear seat-back.

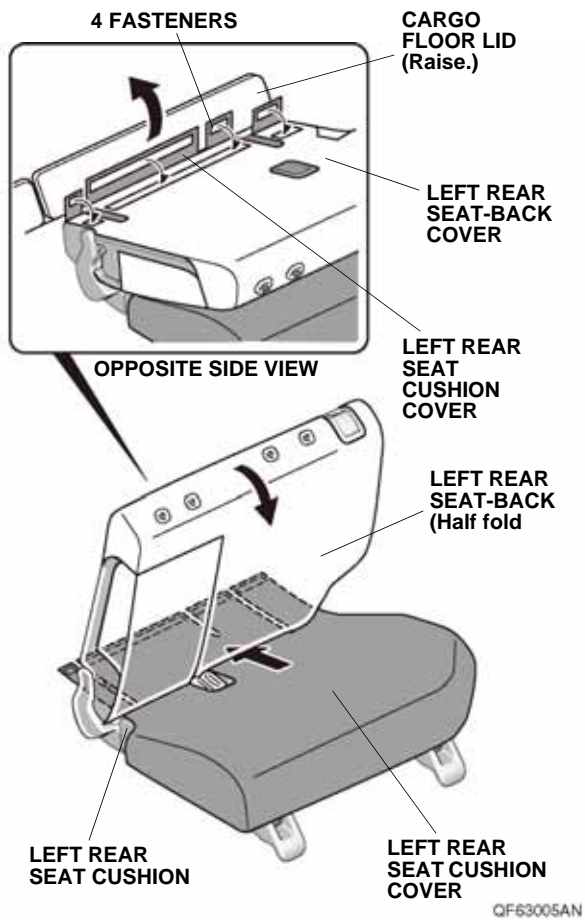

19. Secure the left rear seat cushion cover to the left rear seat-back cover with four fasteners as shown.
20. Raise the left rear seat-back.
21. Install each headrest to the rear seats.