



INSTALLATION INSTRUCTIONS

Accessory
DOOR LOWER TRIMS
P/N 08F57-TLA-100

Application
2020 CR-V

Publications No.
VERSION 1
Issue Date
OCT 2019

PARTS LIST

Left front door lower trim
(Identification mark: FR-L)



Right front door lower trim
(Identification mark: FR-R)



Left rear door lower trim
(Identification mark: RR-L)



Right rear door lower trim
(Identification mark: RR-R)



4 Alcohol wipes



TOOLS AND SUPPLIES REQUIRED

Masking tape

Ruler

The following tool is available through the Honda Tool and Equipment Program. On the iN, click on Service > Service Bay > Tool and Equipment Program, then enter the number under "Search." Or, call 888-424-6857.

Rubber Roller (T/N MHLE54D)

Illustration of the Door Lower Trims on the Vehicle

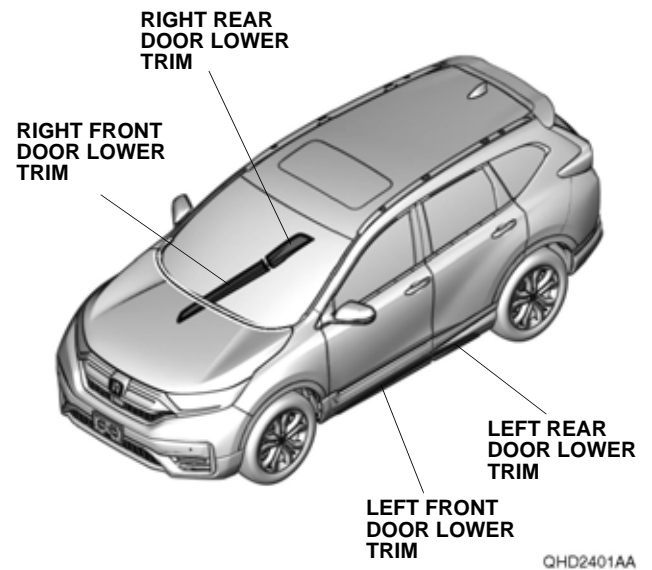

INSTALLATION

Customer Information: The information in this installation instruction is intended for use only by skilled technicians who have the proper tools, equipment, and training to correctly and safely add equipment to your vehicle. These procedures should not be attempted by "do-it-yourselfers."

NOTE:

- Be careful not to damage the body paint finish.
- This kit should be installed only if the ambient air temperature is 60°F (15°C) or above.
- To allow the adhesive to cure, do not wash the vehicle for 24 hours. Make sure the customer is aware of this.

1. Open the left front door, and attach masking tape to the left front door as shown.
NOTE: Wash the bottom of the doors, inside and out, before installing the left front door lower trim.

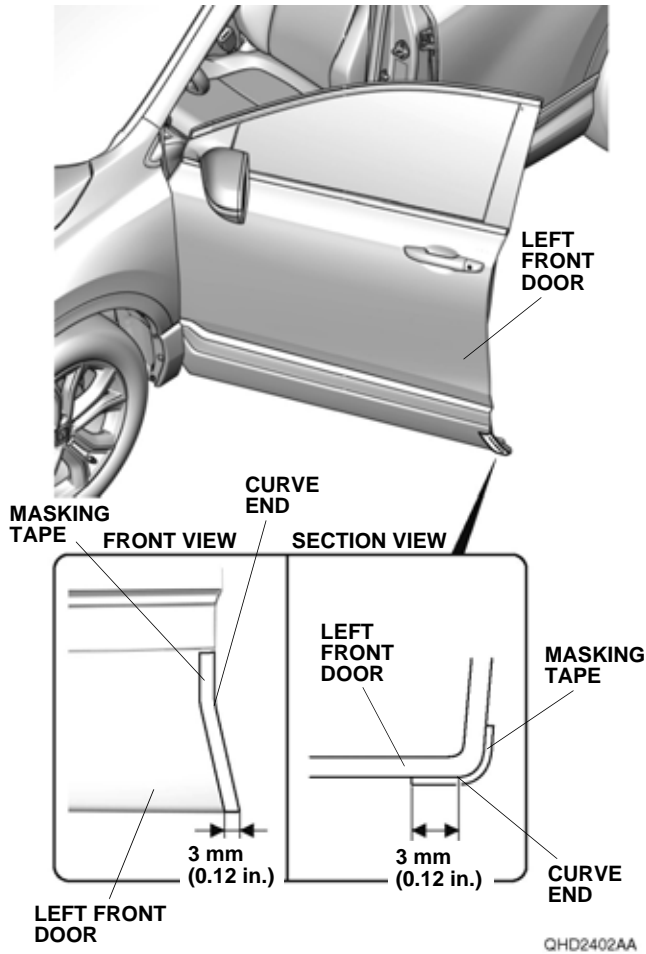

3. Peel back the adhesive backings, and tape them to the front surface of the left front door lower trim with masking tape.
NOTE: Make sure to check the identification mark of the left front door lower trim before installation.

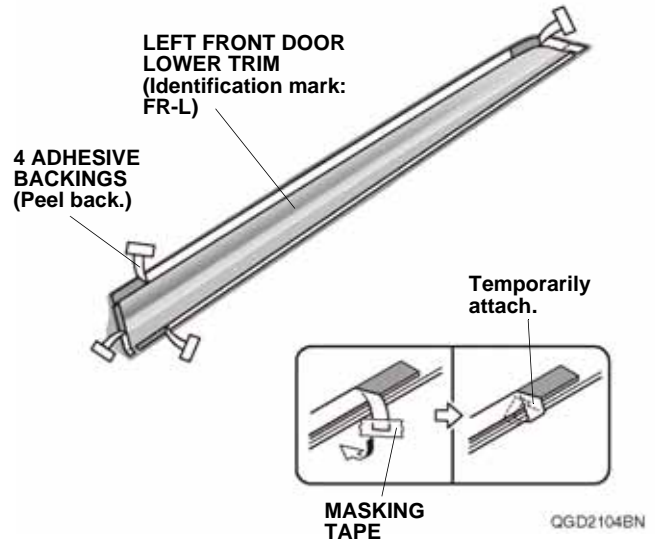

2. Using the alcohol wipe, thoroughly clean the left front door where the left front door lower trim will attach.



4. Line up the left front door lower trim with masking tape as shown.
 NOTE: Make sure that there are no gaps between the left front door and the left front door lower trim.

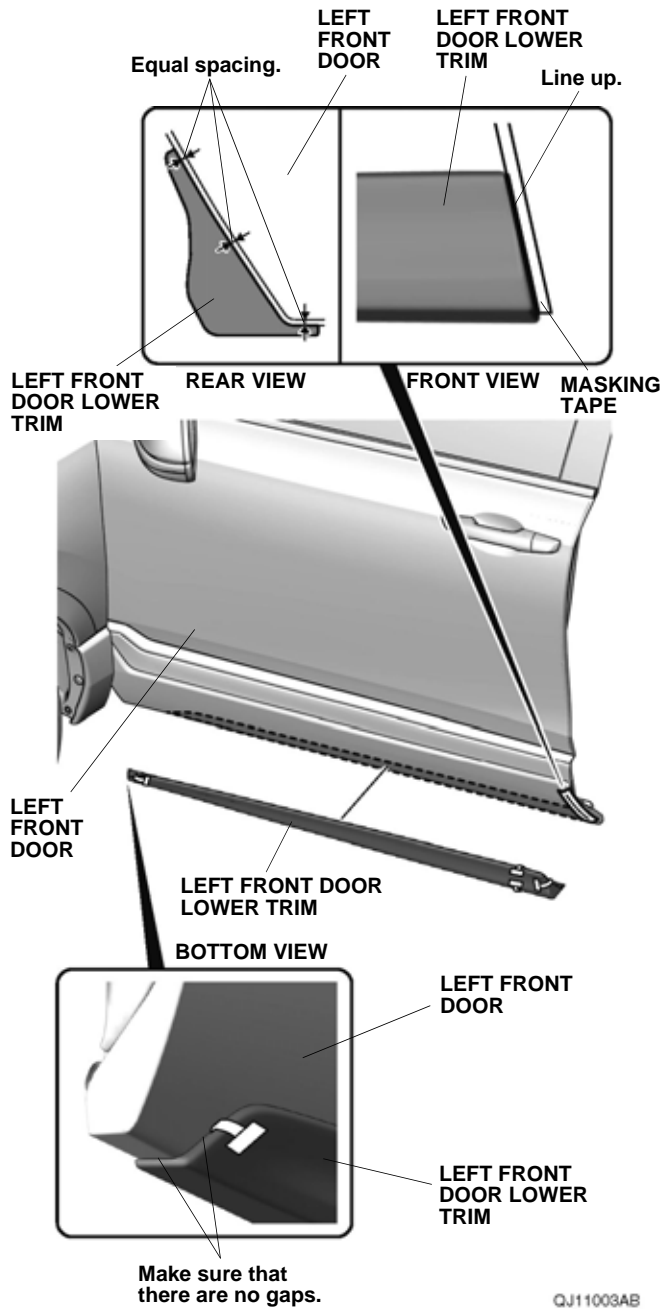

5. Loosely secure the left front door lower trim to the left front door with masking tape as shown.

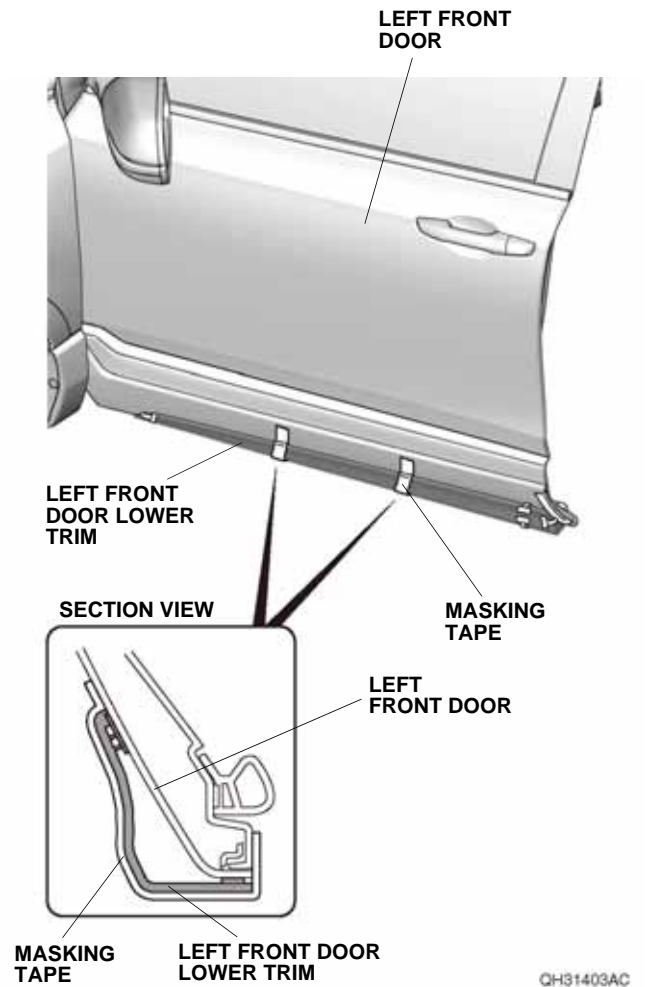

6. While applying light pressure against the left front door lower trim, carefully remove the three adhesive backings as shown.

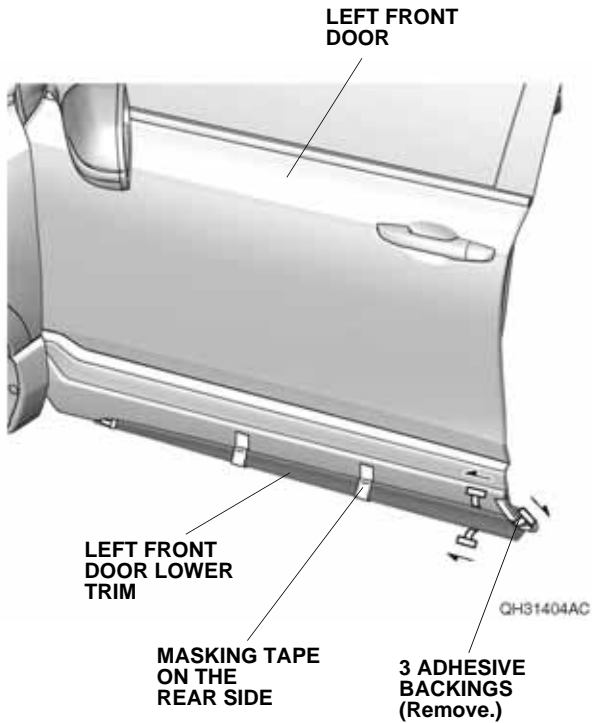

7. Using the rubber roller, apply firm pressure against the rear of the left front door lower trim. Start from the rear side, and roll the left front door lower trim as shown. Apply firm pressure for 30 seconds at 100 mm (3.94 in.) increments. NOTE: Apply firm pressure, especially at the end.

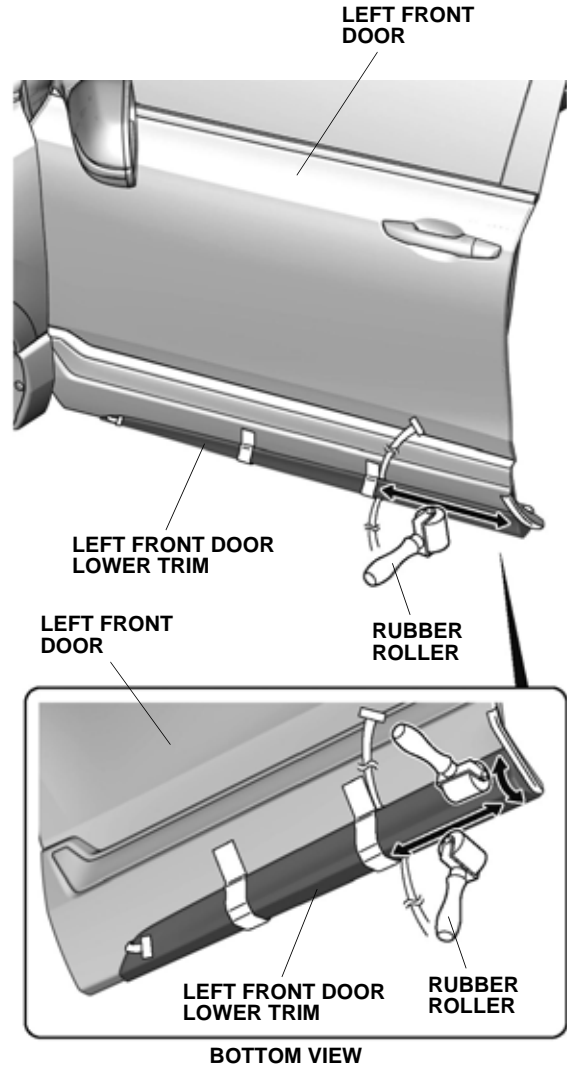

QHD2403AA

8. Remove the masking tape. While applying light pressure against the left front door lower trim, carefully remove the adhesive backings up to the edge of the remaining masking tape.

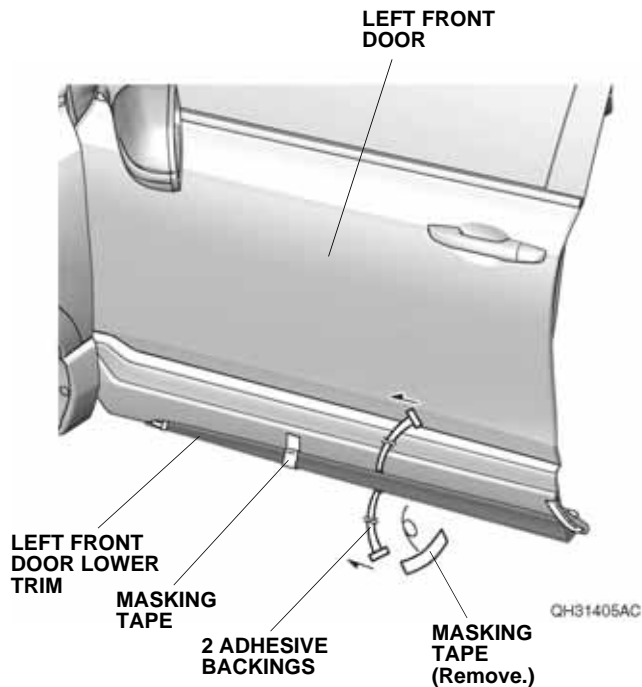

9. Using the rubber roller, apply firm pressure against the center of the left front door lower trim. Start from the rear side, and roll the left front door lower trim as shown. Apply firm pressure for 30 seconds at 100 mm (3.94 in.) increments.

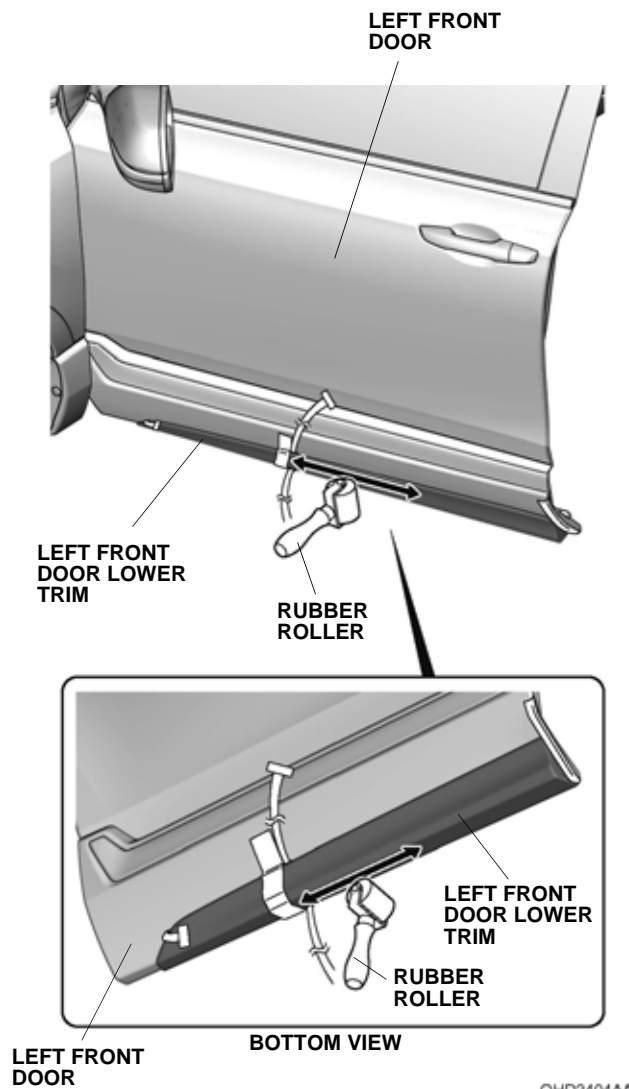

10. Remove the masking tape. While applying light pressure against the left front door lower trim, carefully remove the adhesive backings as shown.

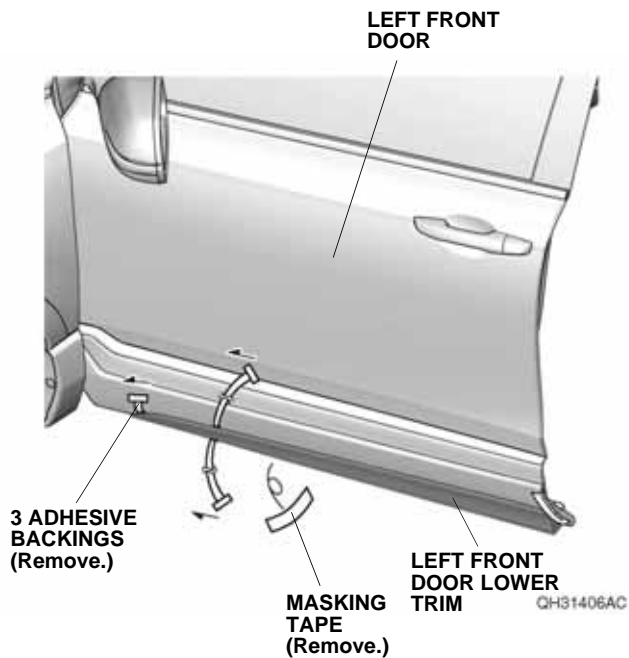

11. Using the rubber roller, apply firm pressure against the front of the left front door lower trim. Start from the rear side, and roll the left front door lower trim as shown. Remove the masking tape. NOTE: Apply firm pressure, especially at the end.

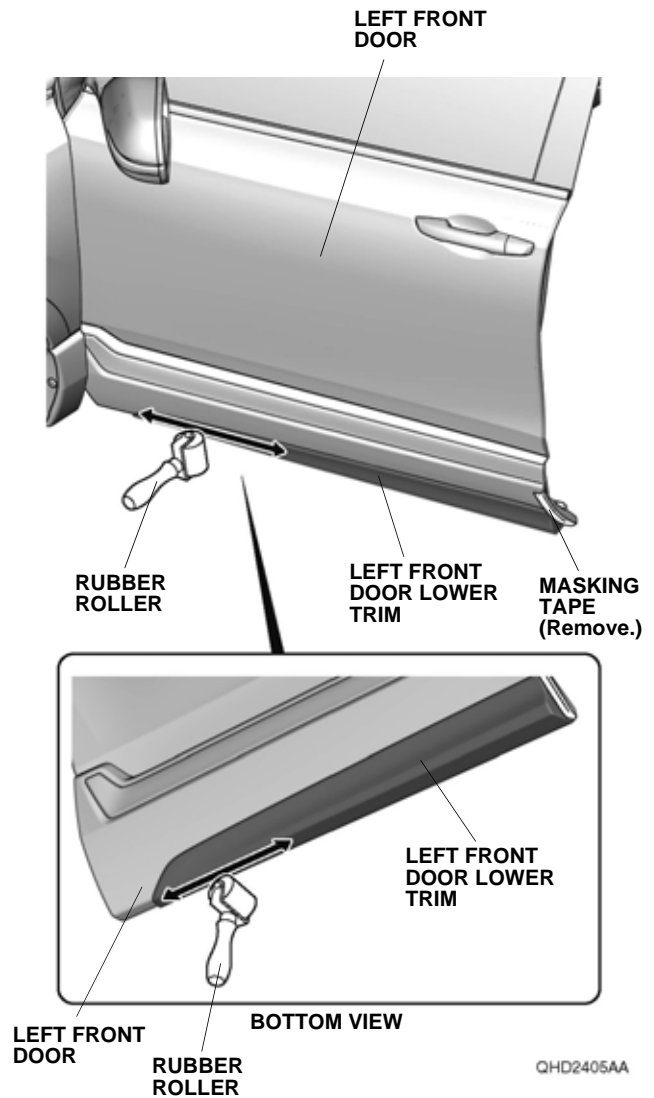

12. Repeat steps 1 through 11 on the right front door.

13. Attach masking tape to the left rear door as shown.

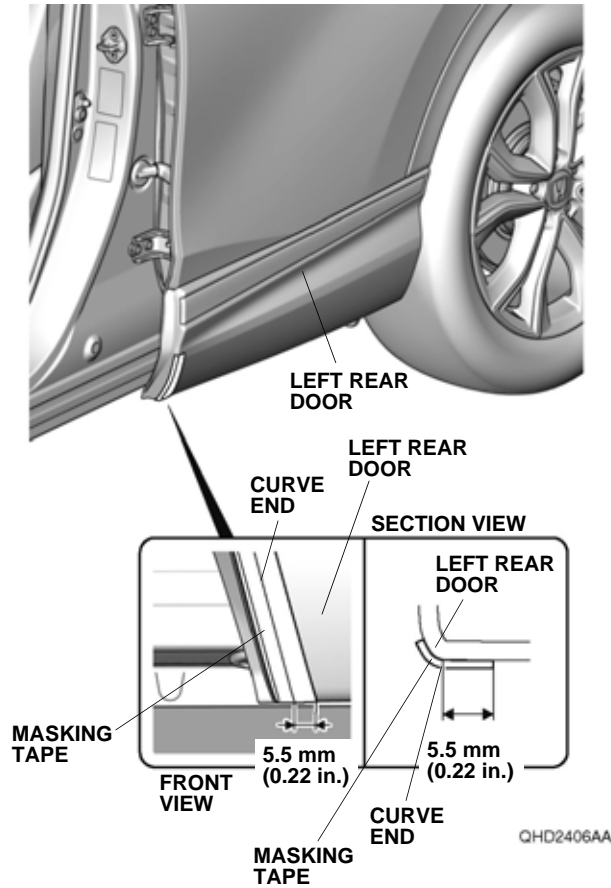

14. Using the alcohol wipe, thoroughly clean the left rear door where the left rear door lower trim will attach.

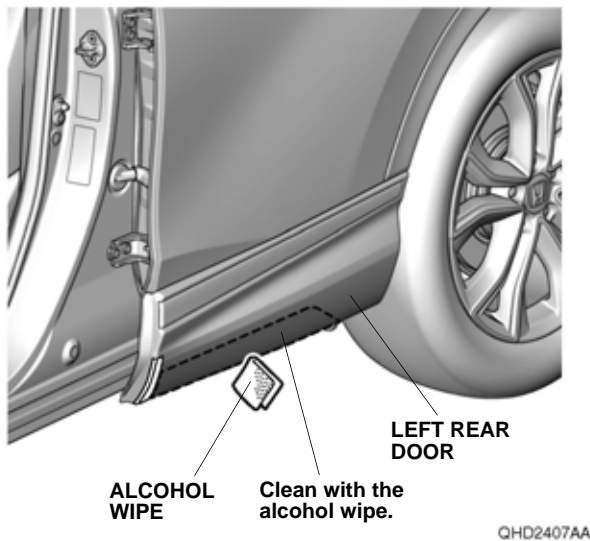

15. Peel back the adhesive backings, and tape them to the front surface of the left rear door lower trim with masking tape.

NOTE: Make sure to check the identification mark of the left rear door lower trim before installation.

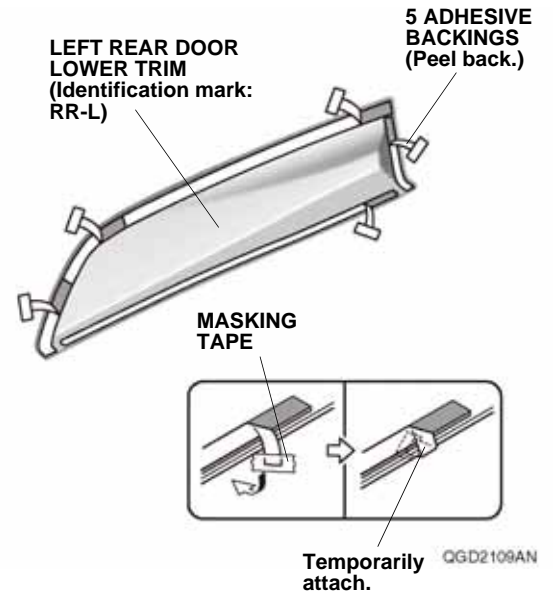

16. Line up the left rear door lower trim as shown.
 NOTE: Make sure that there are no gaps between the left rear door and the left rear door lower trim.

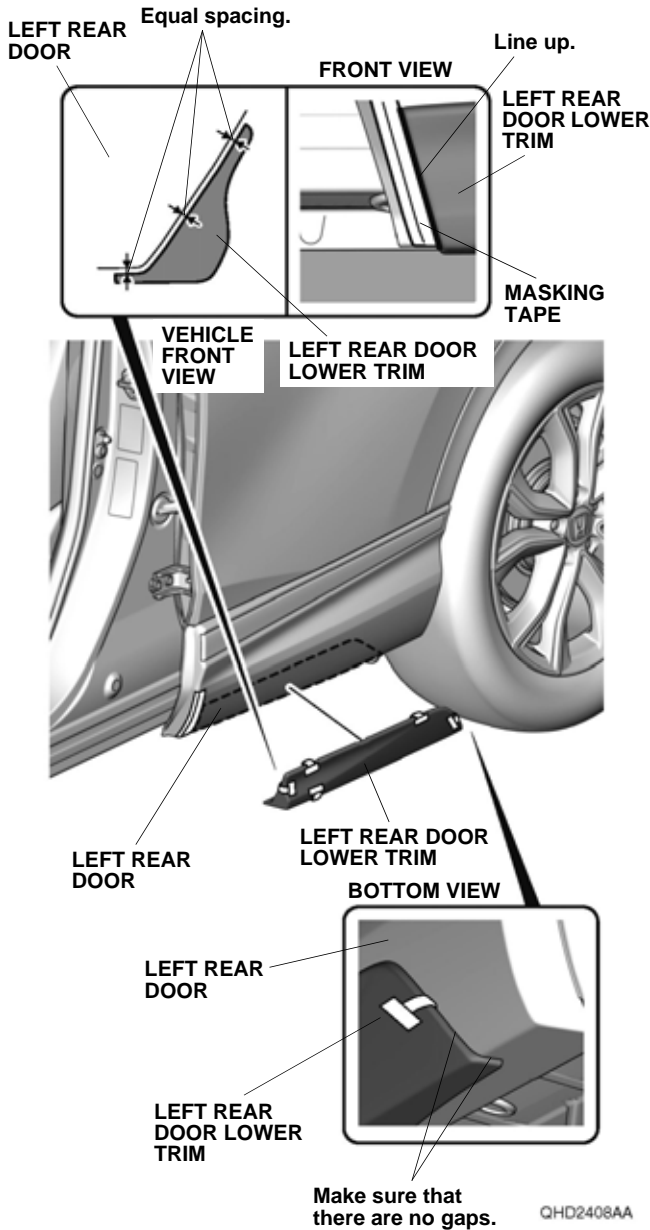

17. Open the left rear door. Loosely secure the left rear door lower trim to the left rear door as shown.

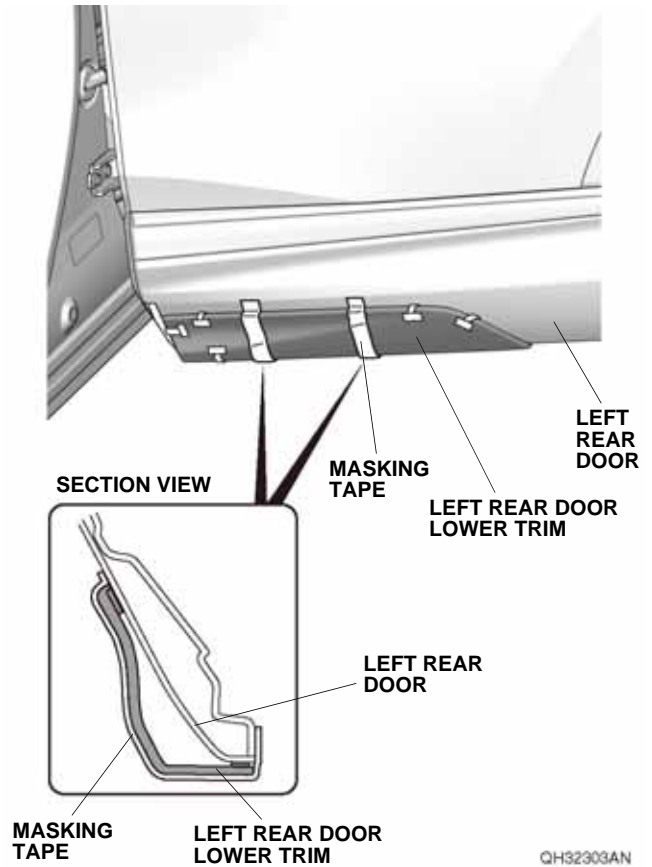

18. While applying light pressure against the left rear door lower trim, carefully remove the taped adhesive backings up to the edge of the masking tape on the front side as shown.

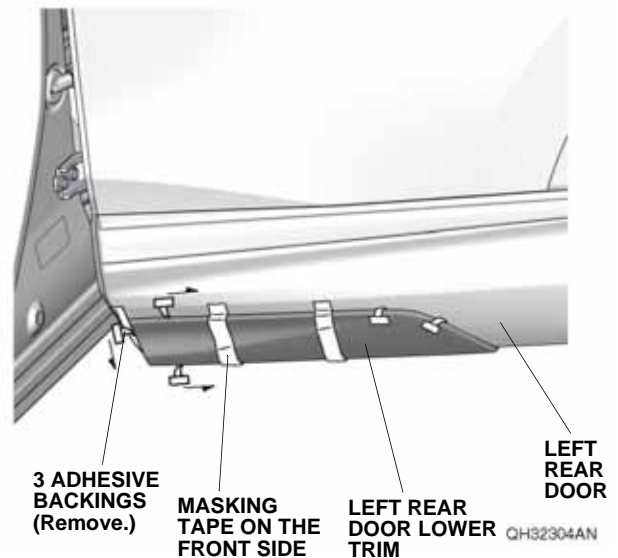

19. Using the rubber roller, apply firm pressure against the front of the left rear door lower trim. Start from the front side, and roll the left rear door lower trim as shown. Apply firm pressure for 30 seconds at 100 mm (3.94 in.) increments.
NOTE: Apply firm pressure, especially at the end.

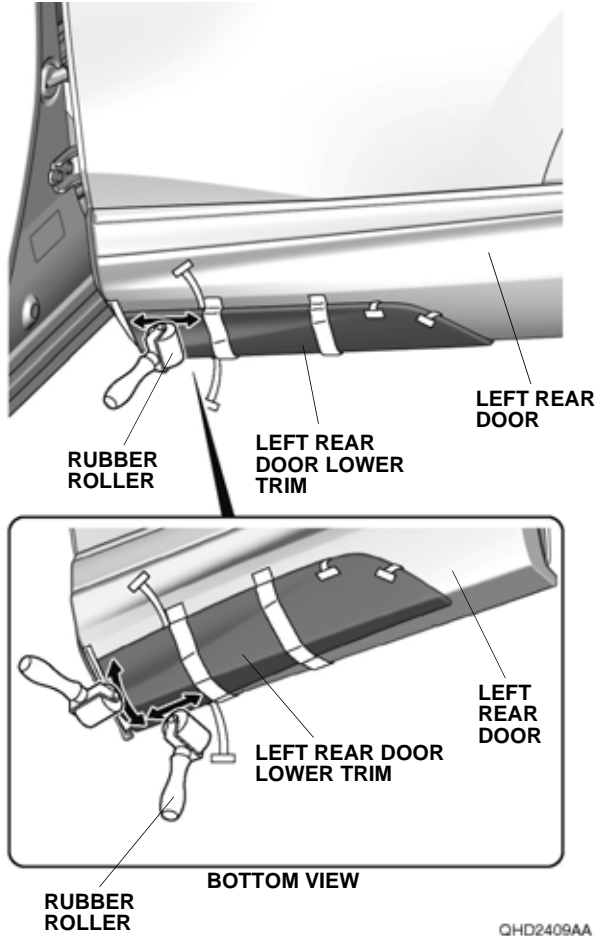

20. Remove the masking tape. While applying light pressure against the left rear door lower trim, carefully remove the adhesive backings up to the edge of the remaining masking tape.

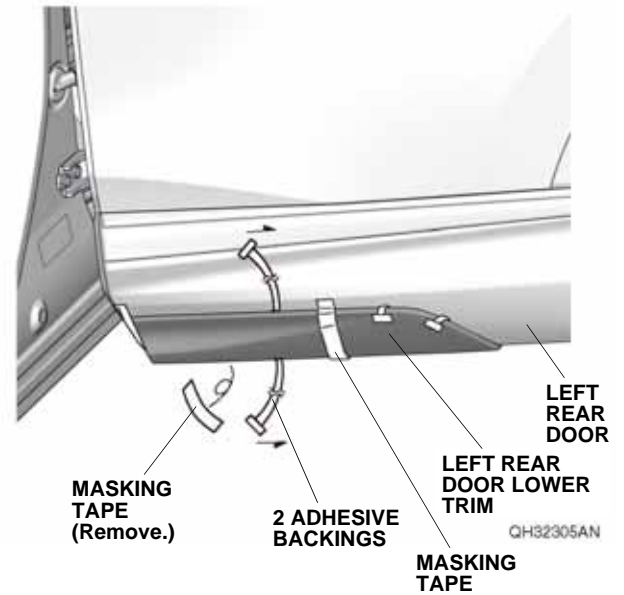

21. Using the rubber roller, apply firm pressure against the center of the left rear door lower trim. Start from the front side, and roll the left rear door lower trim as shown. Apply firm pressure for 30 seconds at 100 mm (3.94 in.) increments.

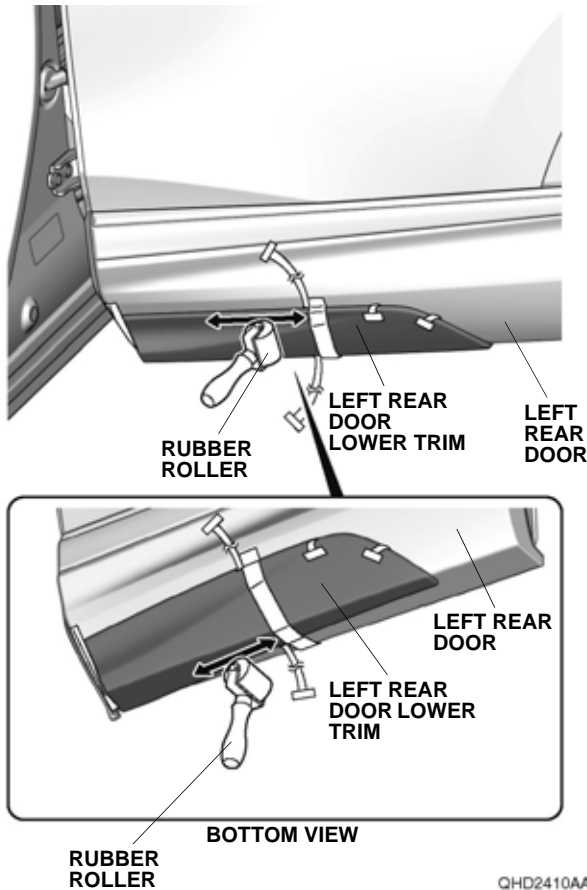

22. Remove the masking tape. While applying light pressure against the left rear door lower trim, carefully remove the adhesive backings as shown.

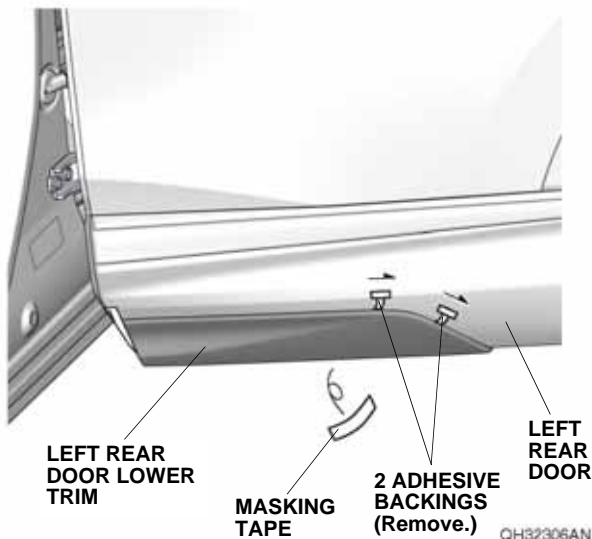

23. Using the rubber roller, apply firm pressure against the rear of the left rear door lower trim. Start from the front side, and roll the left rear door lower trim as shown. Remove the masking tape. NOTE: Apply firm pressure, especially at the end.

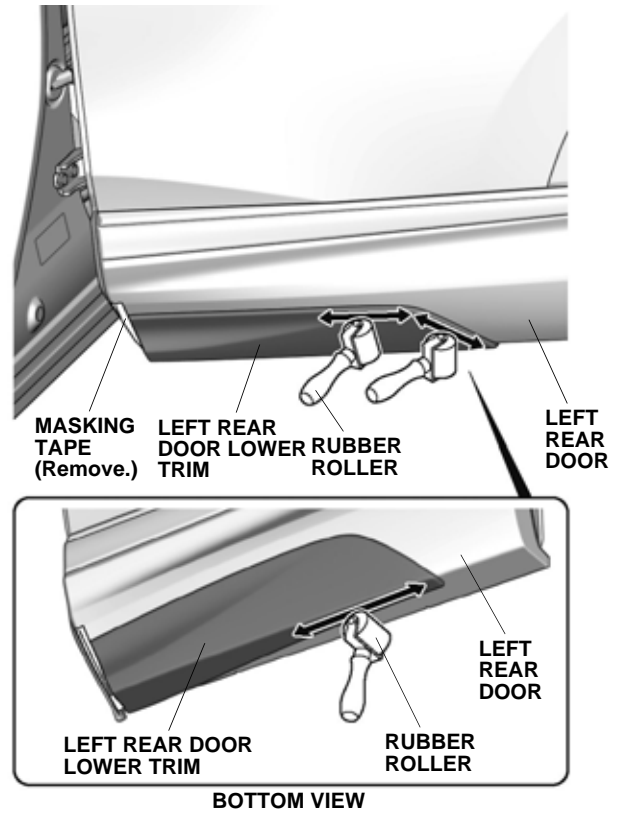

24. Repeat steps 13 through 23 on the right rear door.