



INSTALLATION INSTRUCTIONS

Accessory
SPLASH GUARDS
P/N 08P00-TLA-100

Application
2019 CR-V

Publications No.
VERSION 1
Issue Date
OCT 2018

PARTS LIST

Left front splash guard



Right front splash guard



Left rear splash guard



Right rear splash guard



2 Spring nuts A



4 Spring nuts B

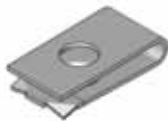

6 Self-tapping screws, 5 x 25 mm



2 Self-tapping screws, 5 x 18 mm



TOOLS AND SUPPLIES REQUIRED

Phillips screwdriver

Stubby Phillips screwdriver

Pushpin

Illustration of the Splash Guards on the Vehicle



INSTALLATION

Customer Information: The information in this installation instruction is intended for use only by skilled technicians who have the proper tools, equipment, and training to correctly and safely add equipment to your vehicle. These procedures should not be attempted by “do-it-yourselfers.”

NOTE:

- Be careful not to damage the paint finish.
- Clean the areas to be covered.

Installing the Front Splash Guards

1. Turn the steering wheel fully counterclockwise.

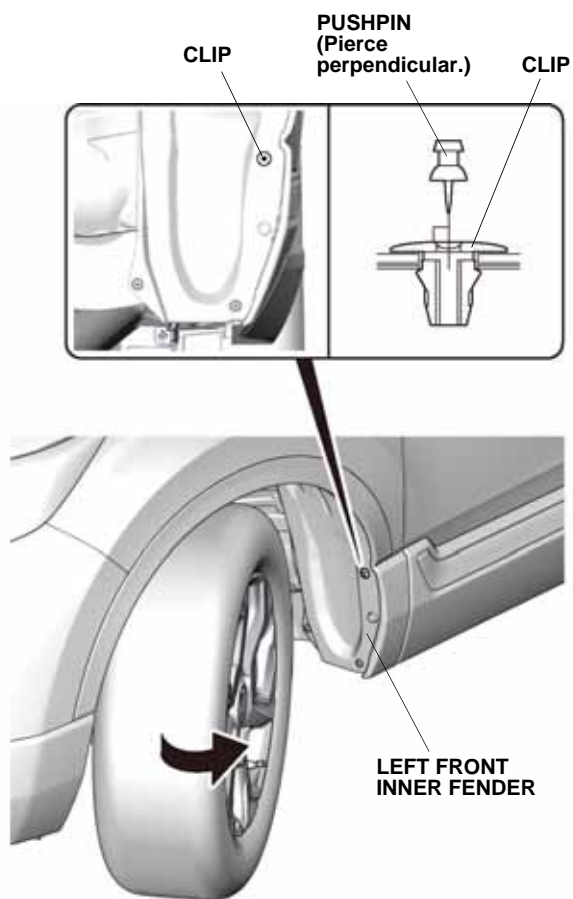

QF20802AX

2. Using a pushpin, pierce the center of the clip on the left front inner fender.
NOTE: Make sure to pierce the clip perpendicular to the fender.

3. Remove two self-tapping screws from the left front inner fender.

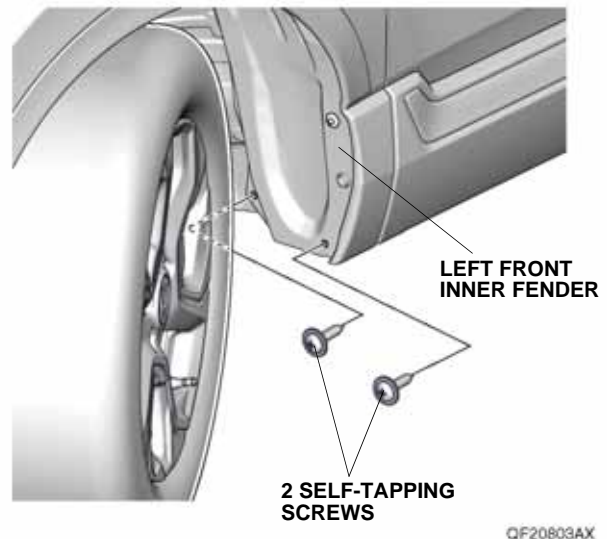

QF20803AX

- Loosely secure the left front splash guard on the left front inner fender with one 5 x 25 mm self-tapping screw and two self-tapping screws removed in step 3.

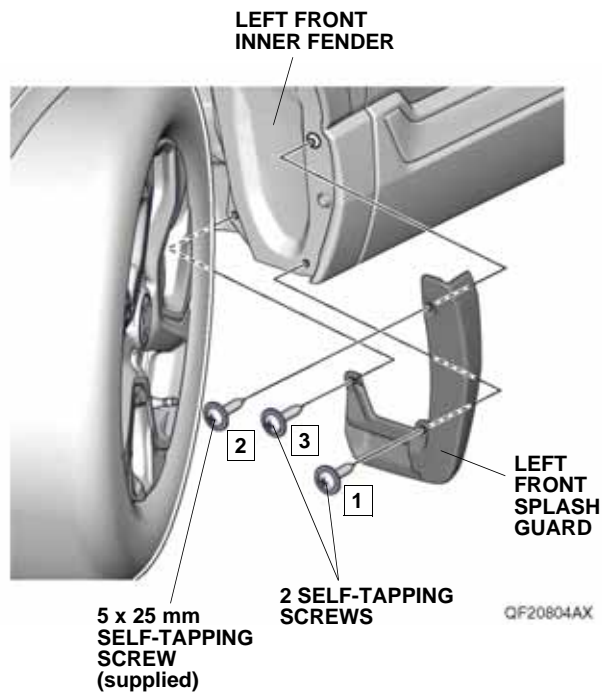

- While holding the left front splash guard against the left front inner fender, tighten one 5 x 25 mm self-tapping screw and two self-tapping screws in the order shown.
NOTE: Make sure there are no gaps between the left front splash guard and the vehicle body. If there is a gap, loosen the self-tapping screws, hold the splash guard against the body, and tighten the screws.
- Turn the steering wheel fully clockwise, and repeat steps 2 through 5 on the right side of the vehicle.

Installing the Rear Splash Guards

- Locate the two dimples. Using a pushpin, pierce the rear bumper at the dimples.
NOTE: Make sure to pierce the dimples perpendicular to the rear bumper.

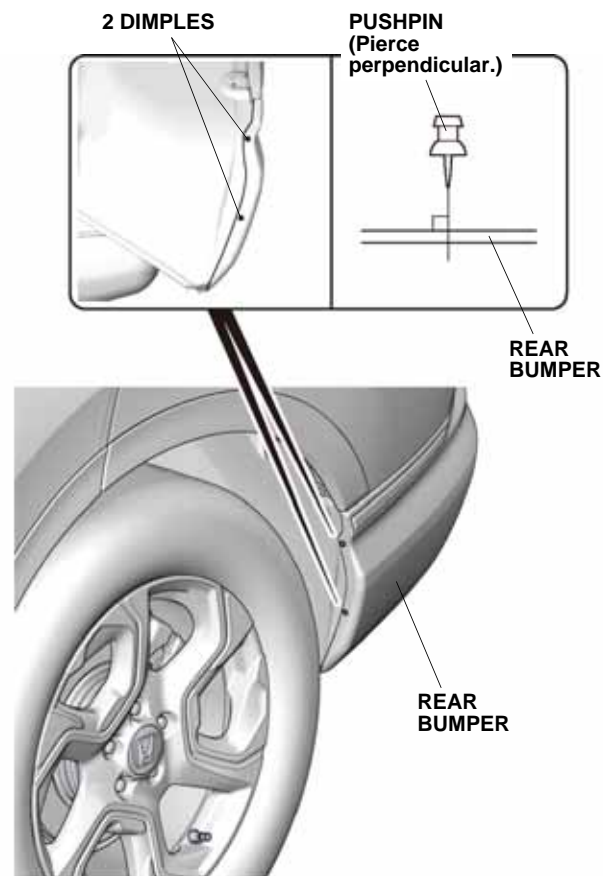

- Thread the 5 x 25 mm self-tapping screw into the pierced dimple. Remove the self-tapping screw. Repeat for the other dimple.

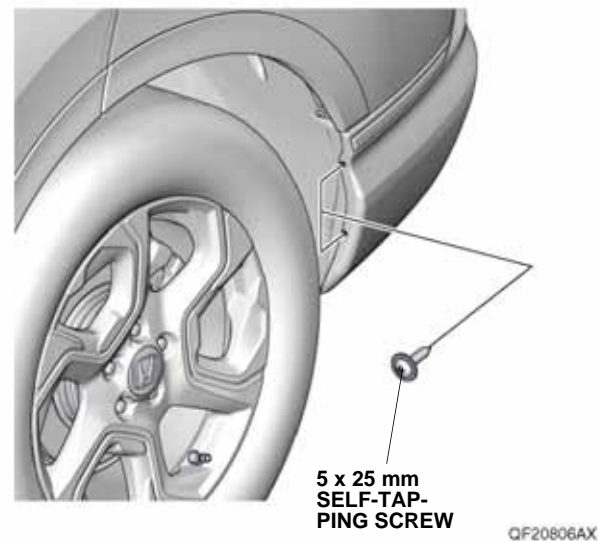

9. Install one spring nut A and two spring nuts B to the rear bumper as shown. Make sure to install the spring nut in the correct position and orientation.

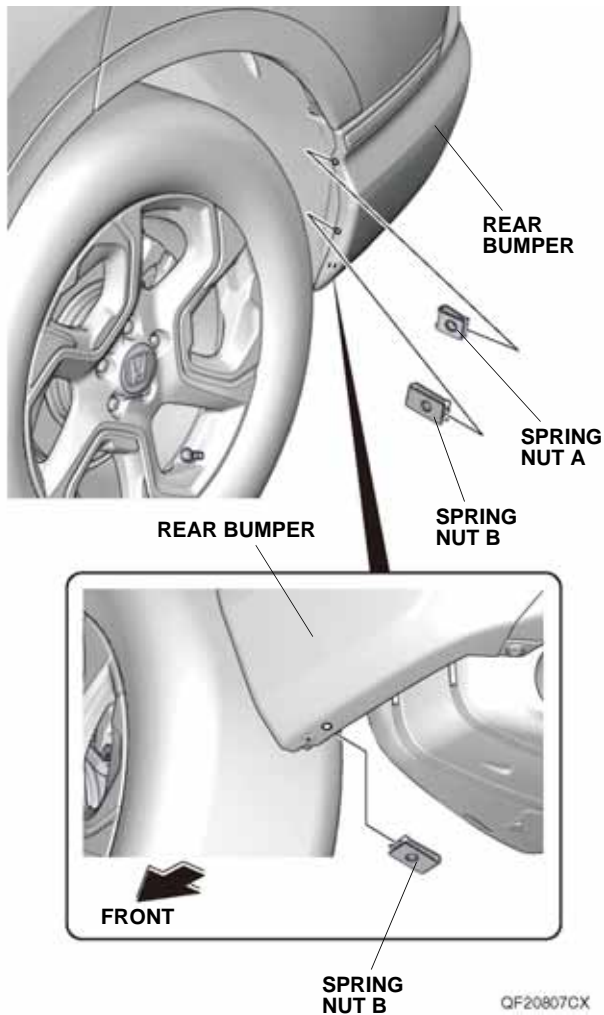

10. Loosely install the left rear splash guard to the rear bumper with two 5 x 25 mm self-tapping screws and one 5 x 18 mm self-tapping screw.

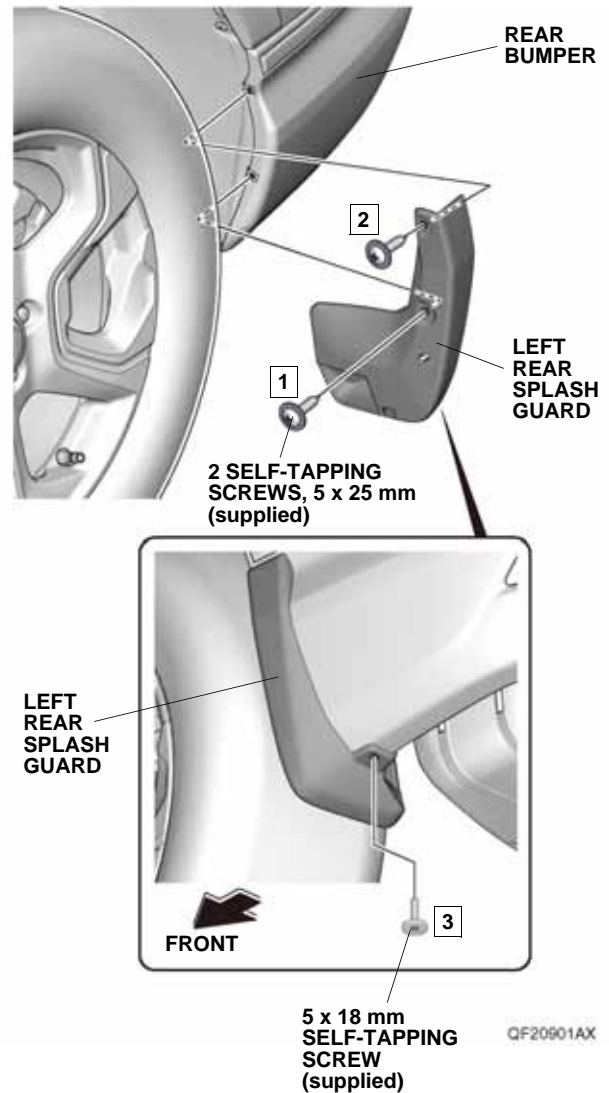

11. While holding the left rear splash guard against the rear bumper, tighten the two 5 x 25 mm self-tapping screws and one 5 x 18 mm self-tapping screw in the order shown.
- NOTE: Make sure there are no gaps between the left rear splash guard and the vehicle body. If there is a gap, loosen the self-tapping screws, hold the splash guard against the body, and tighten the screws.
12. Repeat steps 7 through 11 on the right side of the vehicle.