



INSTALLATION INSTRUCTIONS

Accessory
RUNNING BOARDS
 P/N 08L33-TLA-100

Application
2019 CR-V

Publications No.
VERSION 1
 Issue Date
OCT 2018

PARTS LIST

Left running board



Right running board



2 Brackets A



2 Brackets B



2 Brackets C



Left bracket D



Right bracket D



48 Flange bolts
 (Black or silver)



2 Cushion tapes



TOOLS AND SUPPLIES REQUIRED

Ratchet

10 mm, 12 mm, and 17 mm Sockets

Torque wrench

Utility knife

Ruler

Felt-tip pen

Shop towel

Isopropyl alcohol

The following tools are available through the Honda Tool and Equipment Program. On the iN, click on Service > Service Bay > Tool and Equipment Program, then enter the number under "Search." Or, call 888-424-6857.

- Trim Tool Set (T/N SOJATP2014)
- Plastic Trim Tool (T/N SILTRIMTL10)

Illustration of the Running Boards on the Vehicle

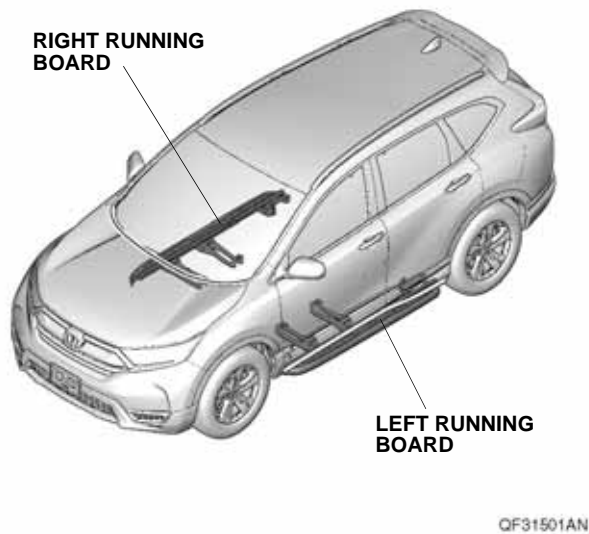

INSTALLATION

Customer Information: The information in this installation instruction is intended for use only by skilled technicians who have the proper tools, equipment, and training to correctly and safely add equipment to your vehicle. These procedures should not be attempted by “do-it-yourselfers.”

NOTE:

- Thoroughly clean the bottom of the body between the front and rear wheels.
- Be careful not to damage the body paint finish.
- These instructions show the left side running board being installed; the same procedure applies to installing the right running board.

With the vehicle on a lift, locate the floor under cover. If the vehicle is equipped with the one-piece floor under cover, continue with step 1; if the vehicle is equipped with the separate floor under covers, go to step 6.

With one-piece floor under cover

1. Remove the floor under cover.

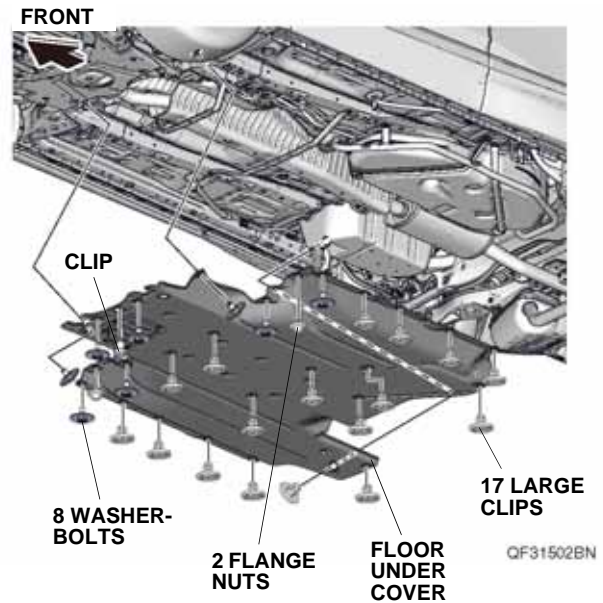

If the vehicle is equipped with the insulator on the floor under cover, continue with step 2; otherwise, go to step 4.

With insulator

- Using a utility knife, cut the insulator on the floor under cover and fold it into the inside of the insulator as shown.

NOTE: Do not cut into the padding. Do not peel off the bonded part on the insulator.

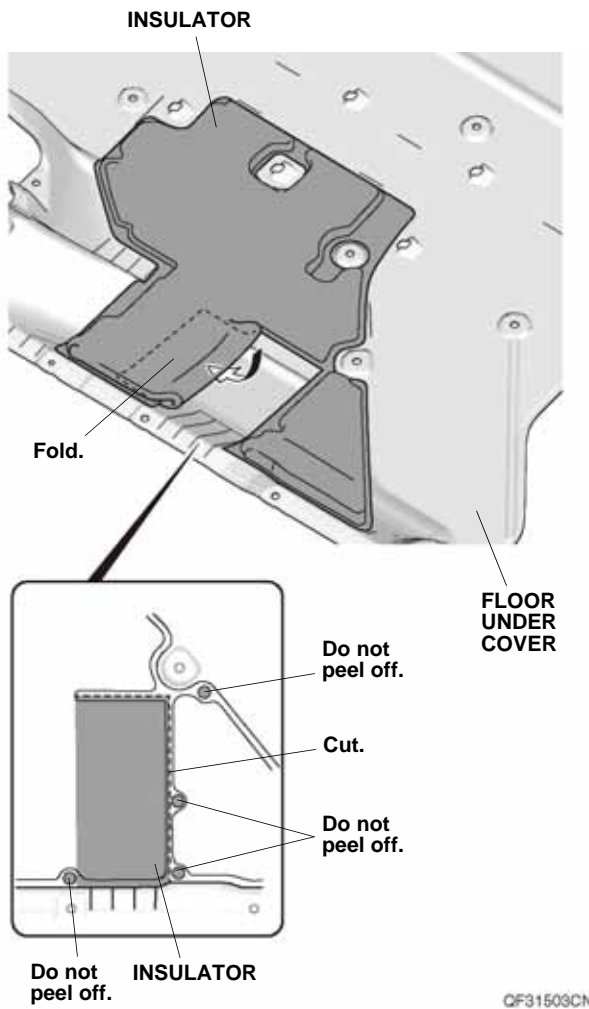

- Using a utility knife, cut the insulator on the floor under cover and fold it into the inside of the insulator as shown.

NOTE: Do not cut into the padding. Do not peel off the bonded part on the insulator.

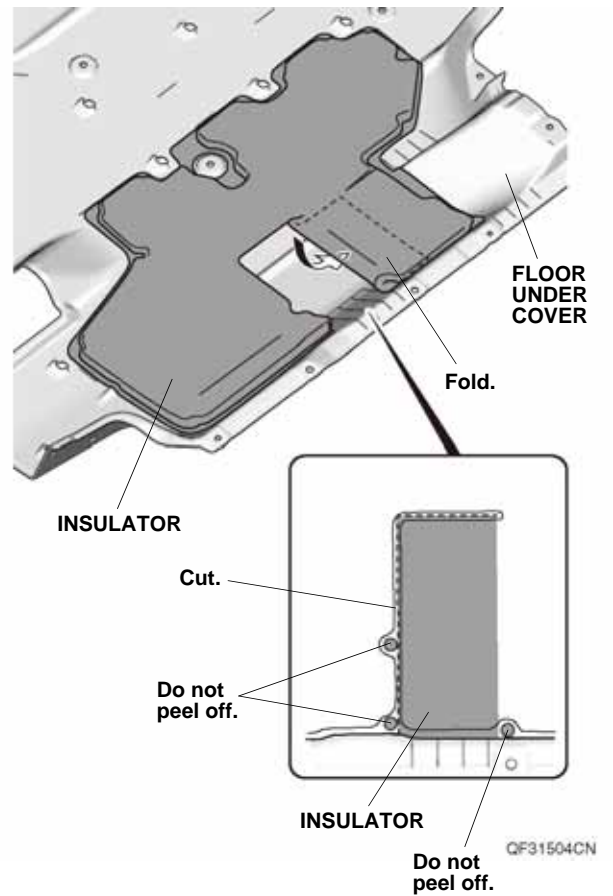

4. Using a utility knife, cut off the floor under cover as shown.

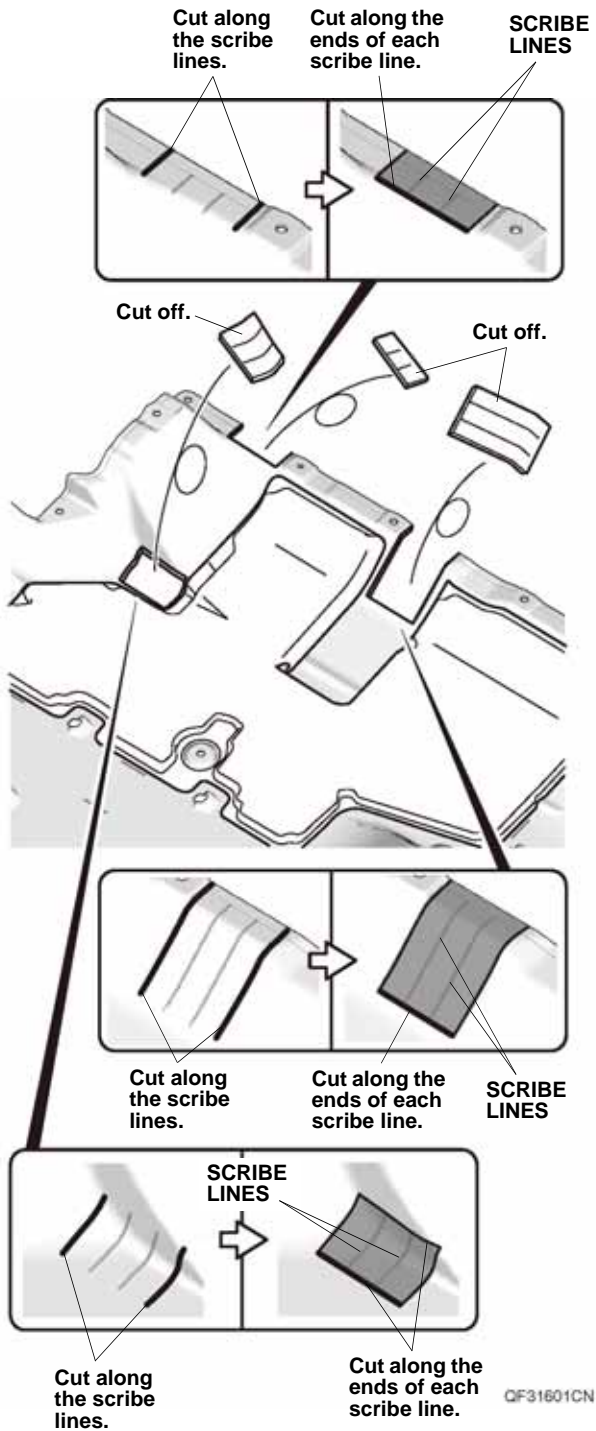

5. Using a utility knife, cut off the floor under cover as shown. Go to step 16.

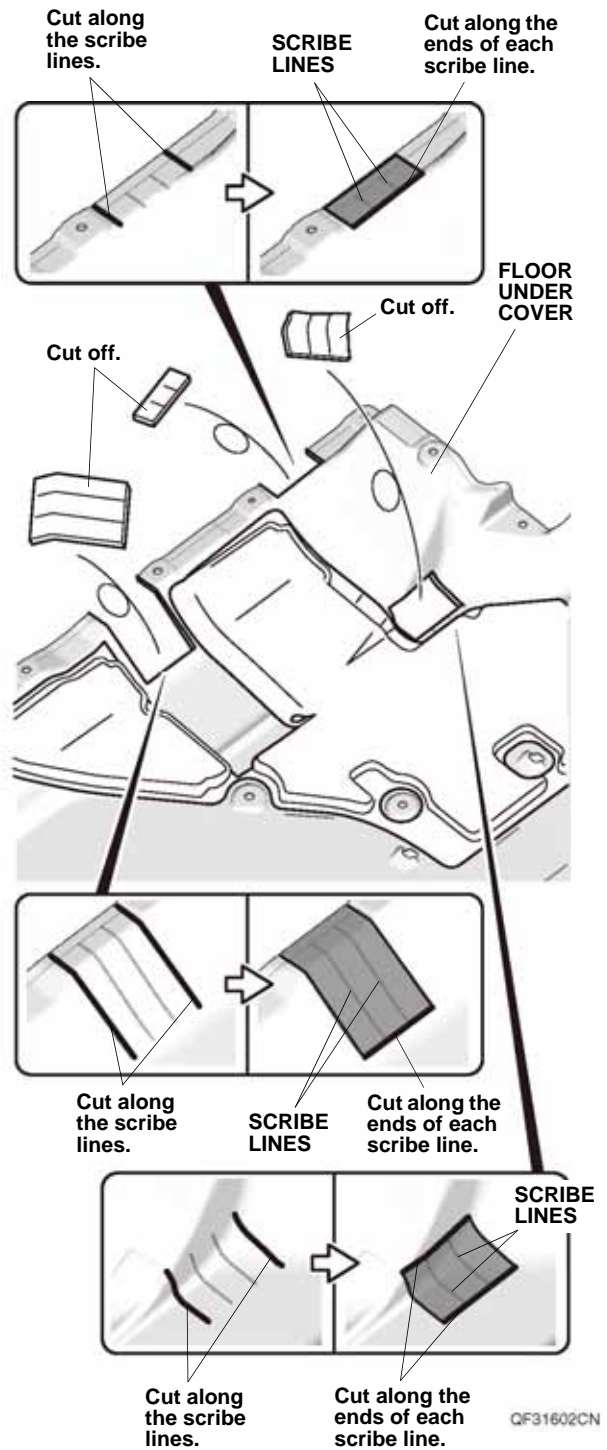

With separate floor under covers

6. Remove the left floor under cover.

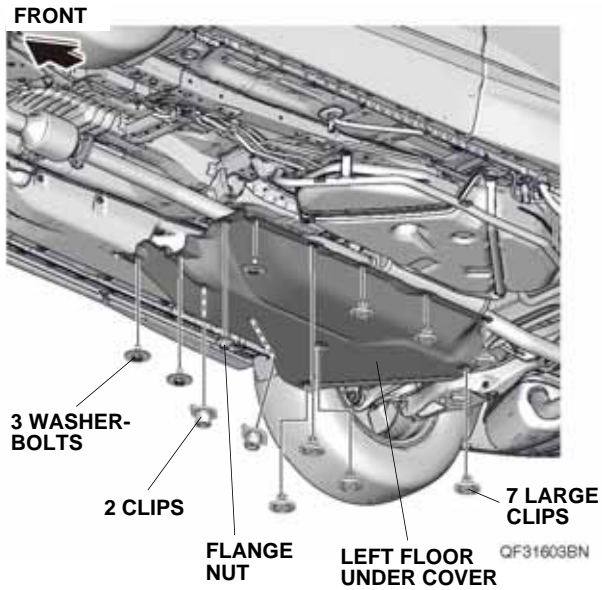

7. Remove the right floor under cover.

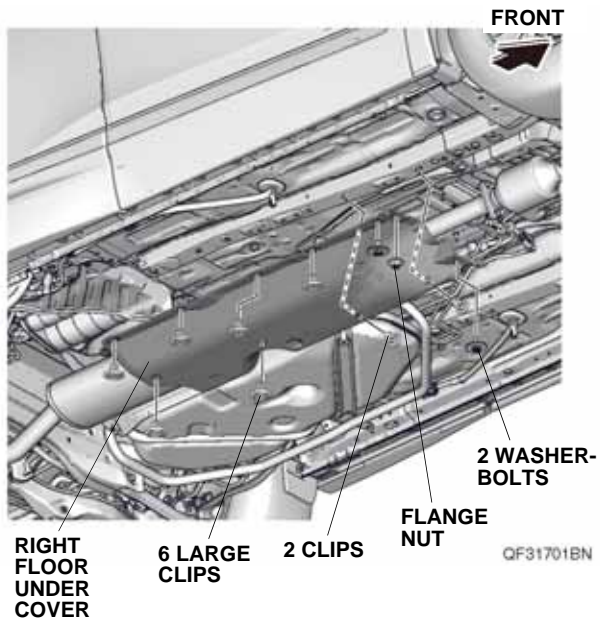

If the vehicle is equipped with the insulator on the floor under covers, continue with step 8; otherwise, go to step 10.

With insulator

8. Using a utility knife, cut the insulator on the left floor under cover and fold it into the inside of the insulator as shown.

NOTE: Do not cut into the padding. Do not peel off the bonded part on the insulator.

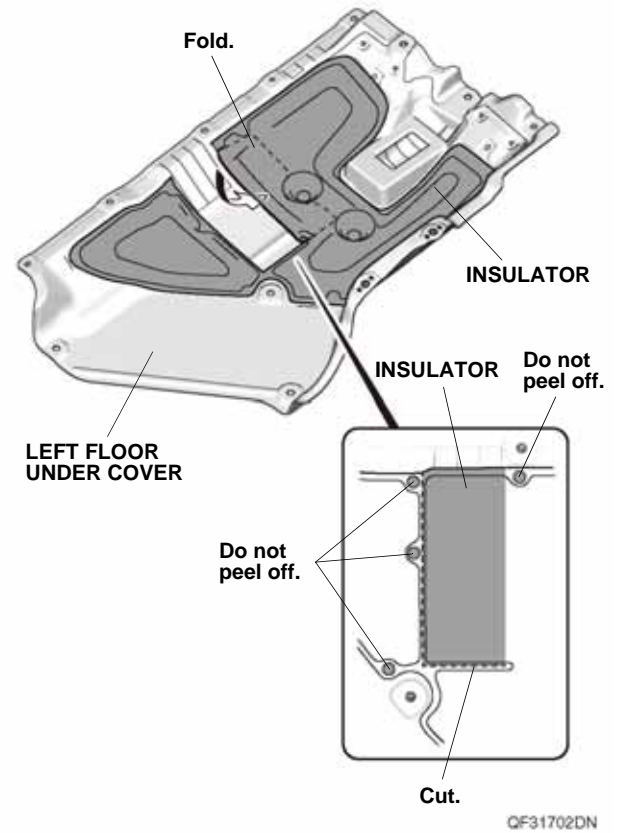

9. Using a utility knife, cut the insulator on the right floor under cover and fold it into the inside of the insulator as shown.

NOTE: Do not cut into the padding. Do not peel off the bonded part on the insulator.

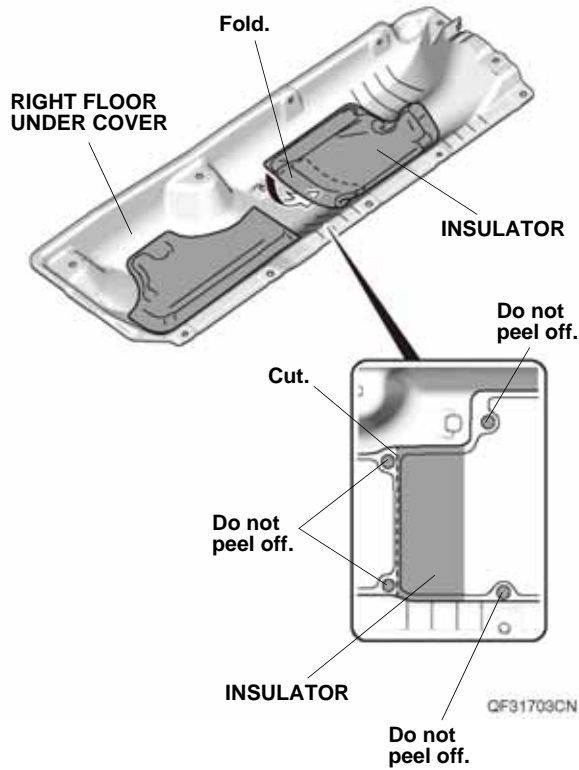

10. Using a utility knife, cut off the right floor under cover as shown.

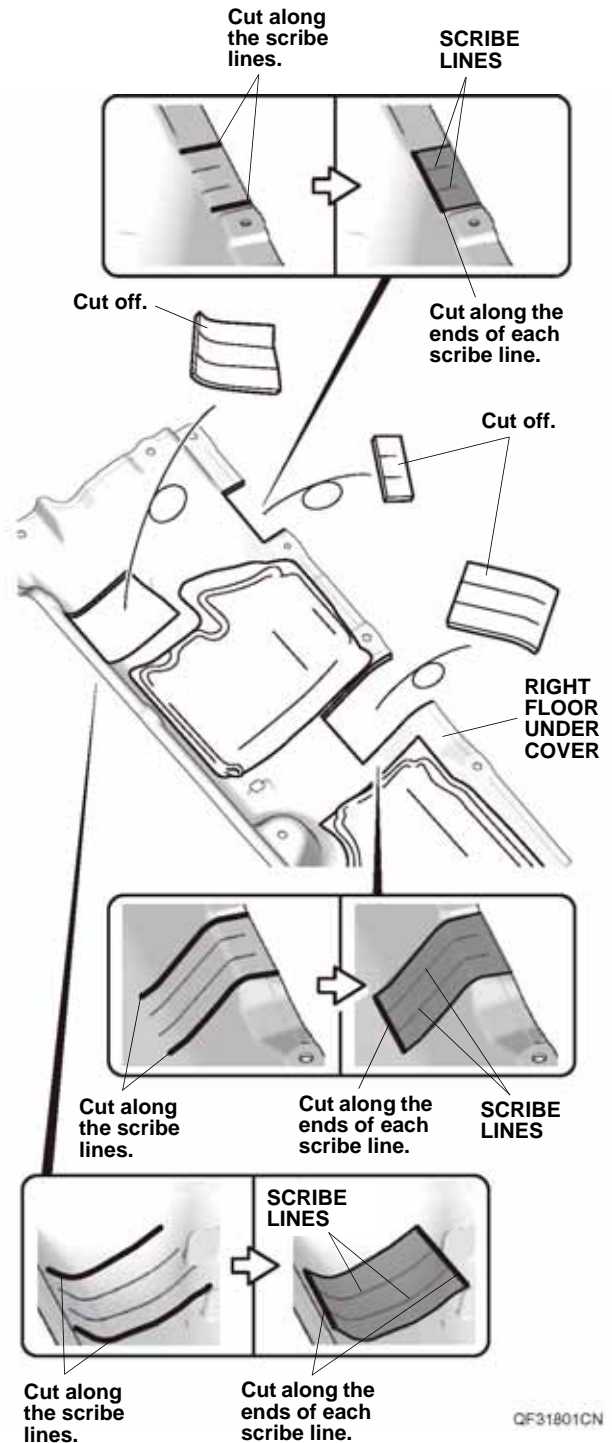

11. Using a felt-tip pen, mark the left floor under cover as shown.

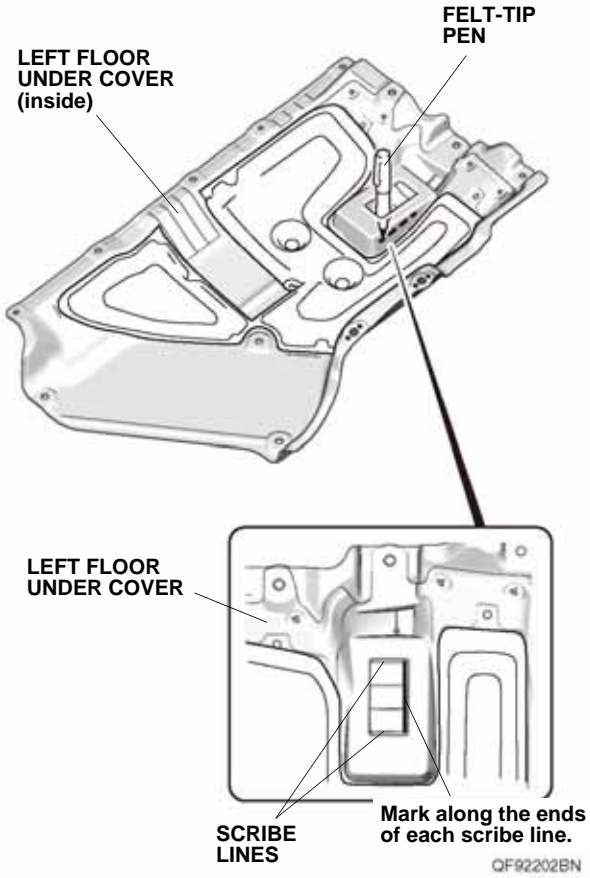

12. Using a utility knife, cut the left floor under cover as shown.

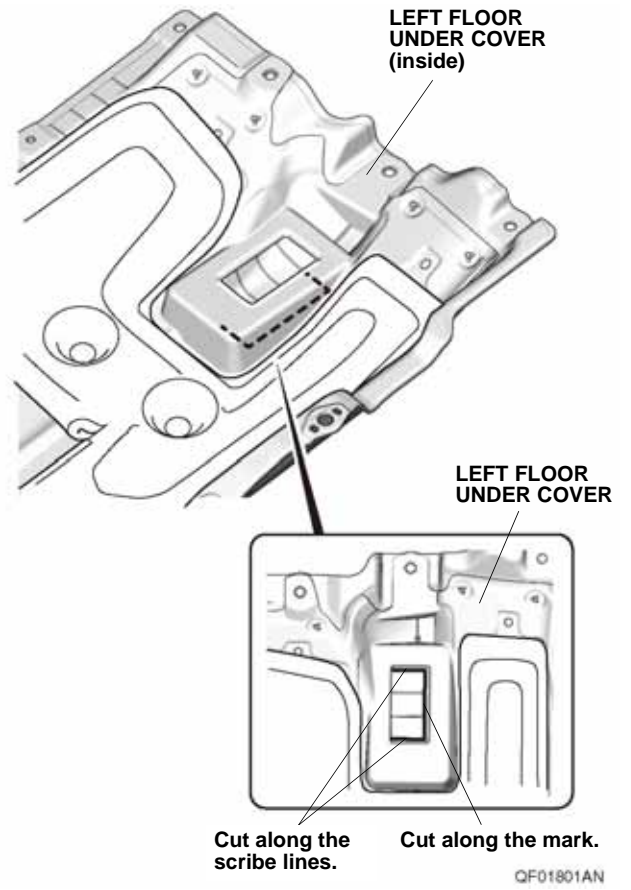

13. Using a felt-tip pen, mark the left floor under cover as shown.

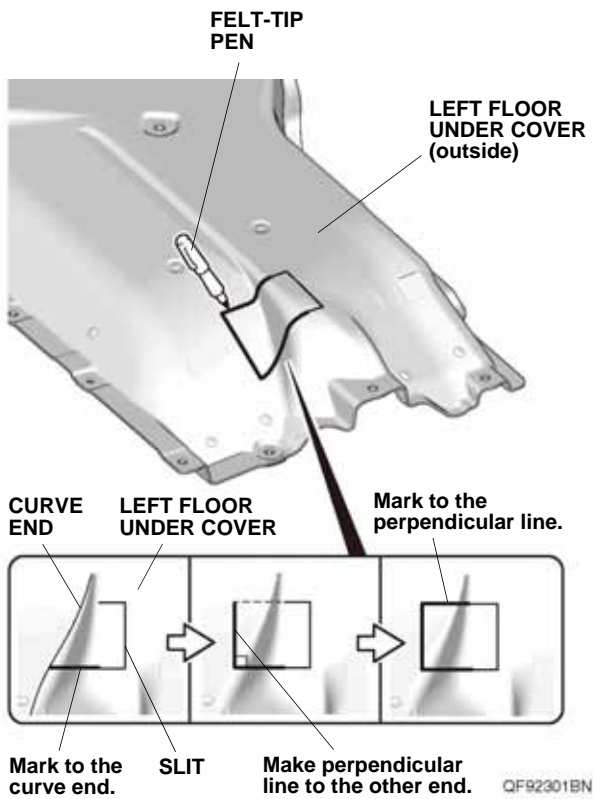

14. Using a utility knife, cut off the left floor under cover along the mark.
NOTE: Be careful not to damage the inside parts.

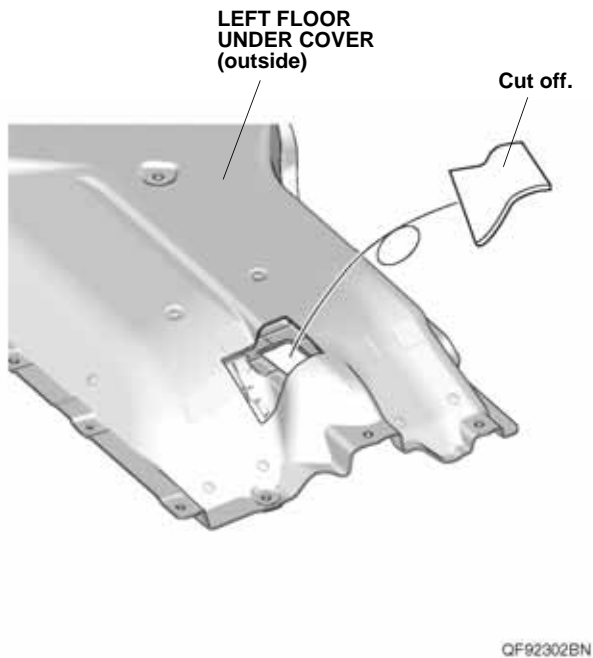

15. Using a utility knife, cut off the left floor under cover as shown.

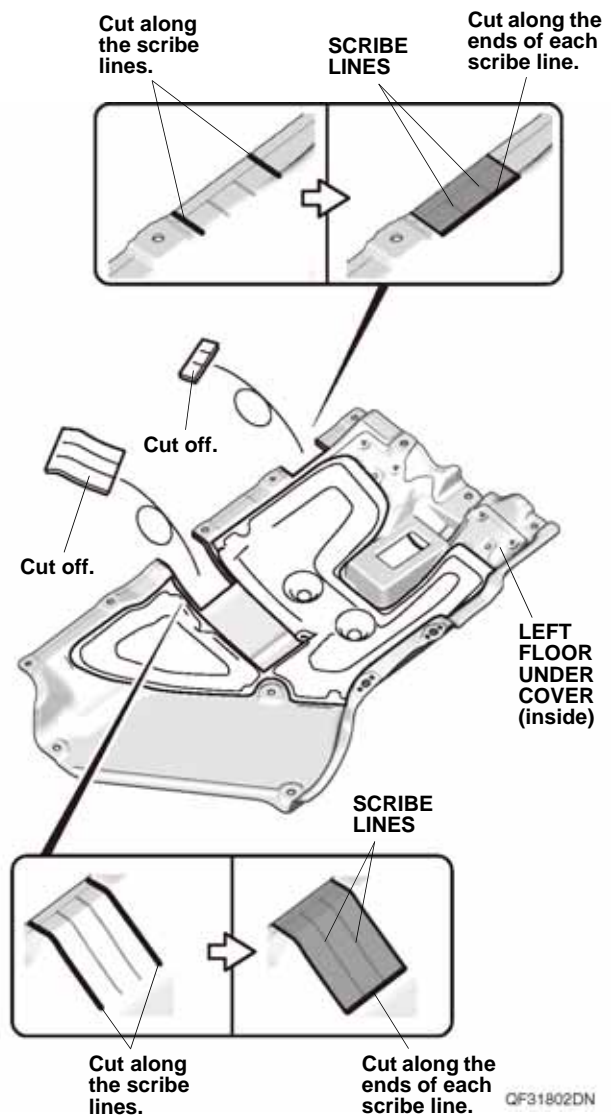

16. Using isopropyl alcohol on a shop towel, thoroughly clean brackets B where the cushion tapes will attach.

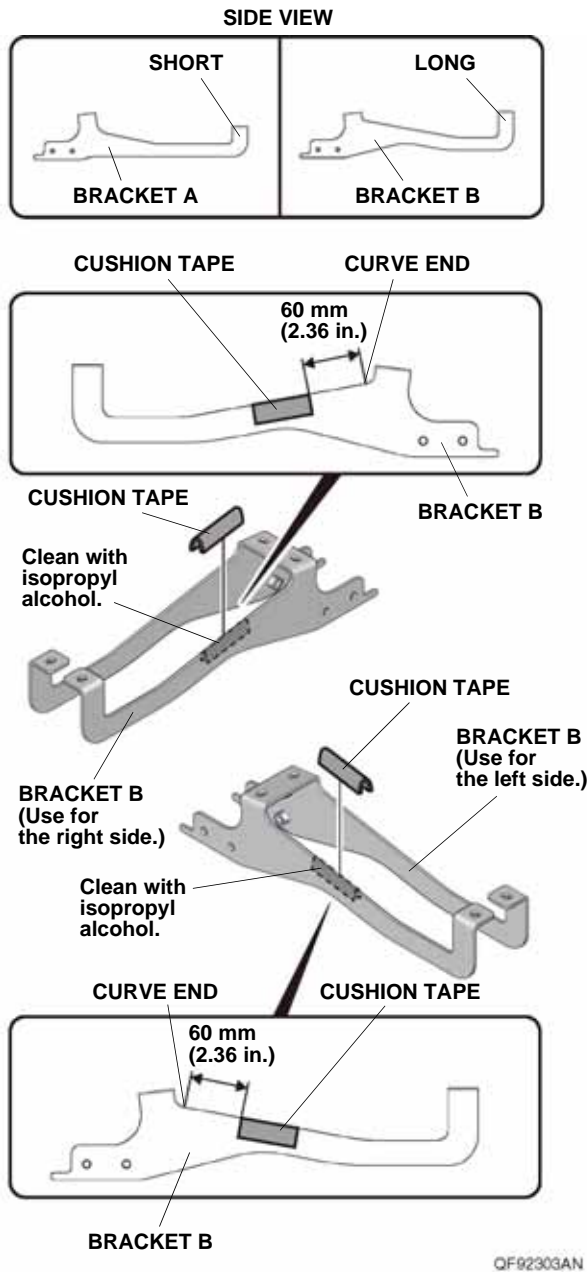

17. Attach one cushion tape to each bracket B as shown. Make sure to attach the cushion tapes in the correct position and orientation.

18. Loosely secure bracket B to the vehicle panel with four flange bolts.

NOTE: If there are black and silver flange bolts in the kit, use the silver flange bolts.

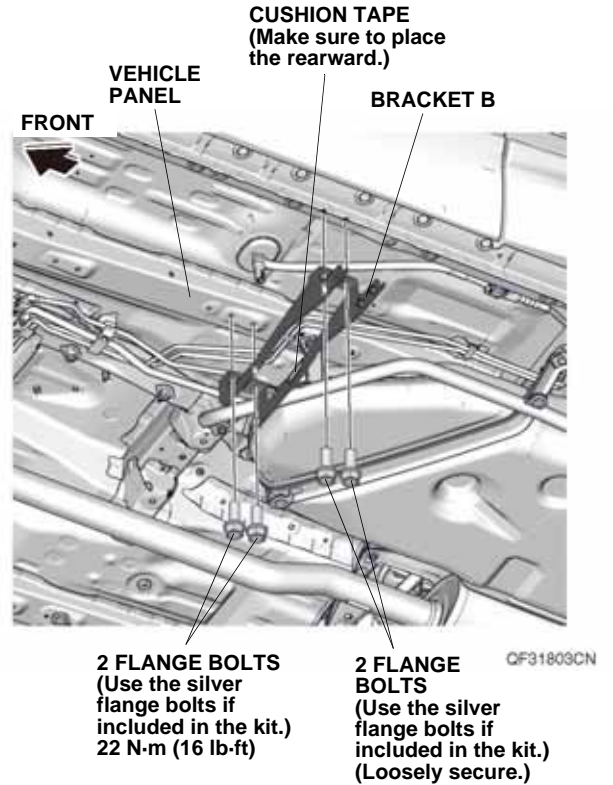

19. Tighten two inboard flange bolts. Torque the flange bolts to 22 N·m (16 lb-ft).
20. Repeat steps 18 and 19 on the right side of the vehicle.

If the vehicle is equipped with the one-piece floor under cover, continue with step 21; if the vehicle is equipped with the separate floor under covers, go to step 22.

With one-piece floor under cover

21. Install the floor under cover. Torque the flange nuts and washer-bolts to 6.9-11.8 N·m (5.1-9 lb·ft). Go to step 24.

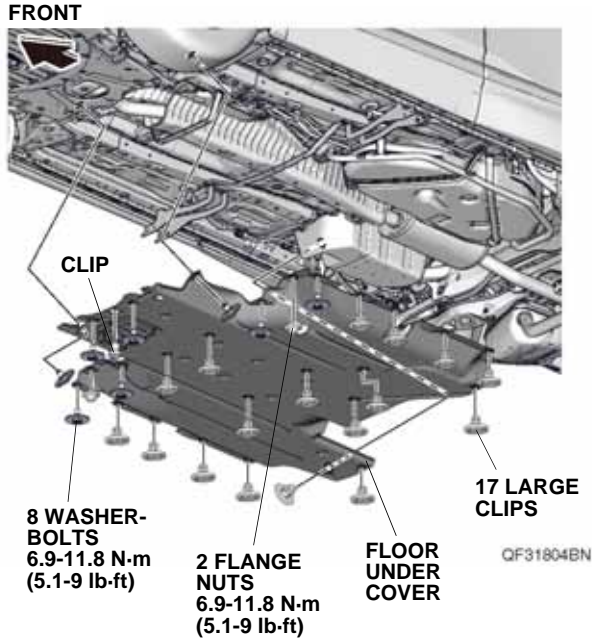

With separate floor under covers

22. Install the left floor under cover. Torque the flange nut and washer-bolts to 6.9-11.8 N·m (5.1-9 lb·ft).

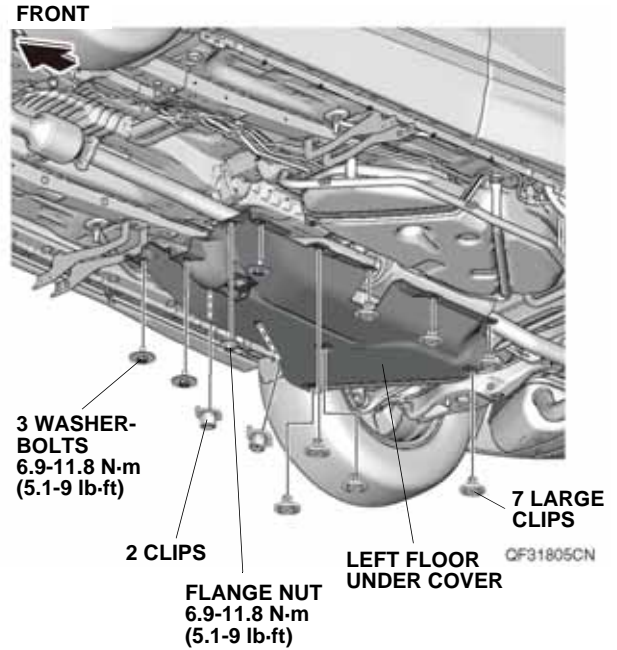

23. Install the right floor under cover. Torque the flange nut and washer-bolts to 6.9-11.8 N·m (5.1-9 lb·ft).

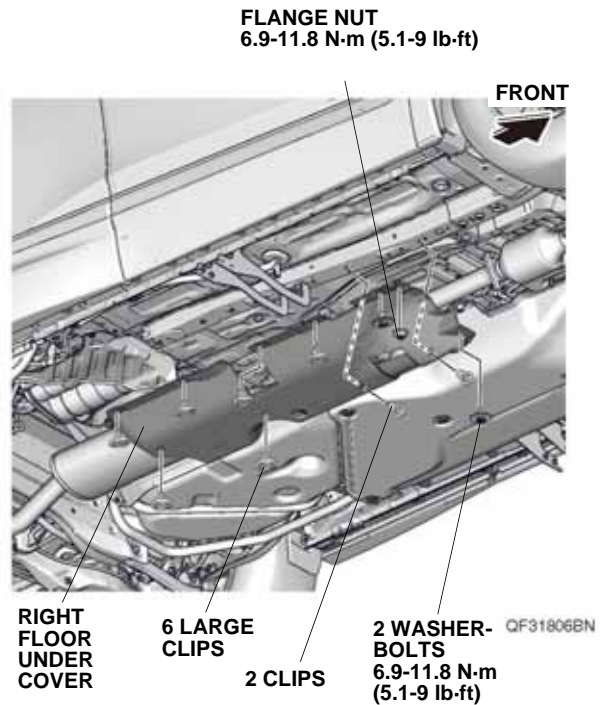

24. Loosely secure bracket A to the vehicle panel with four flange bolts.
 NOTE: If there are black and silver flange bolts in the kit, use the silver flange bolts.

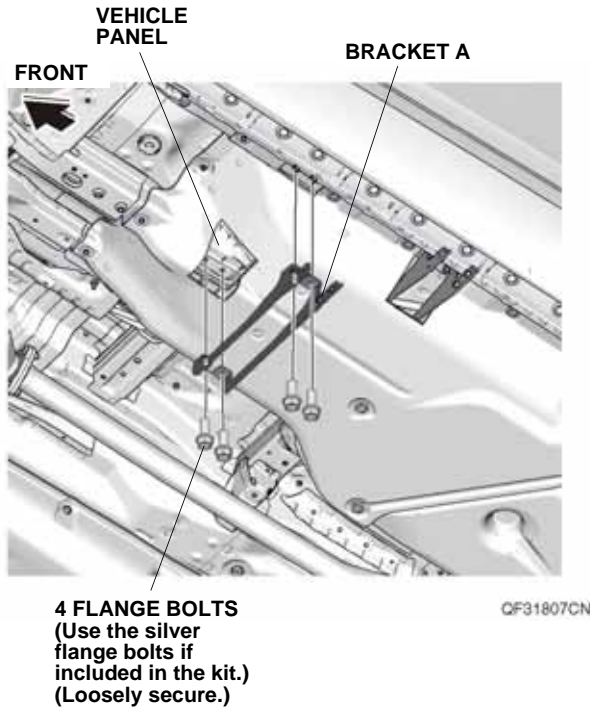

25. Loosely secure bracket C and left bracket D to the vehicle panel with three flange bolts.
 NOTE: If there are black and silver flange bolts in the kit, use the silver flange bolts.

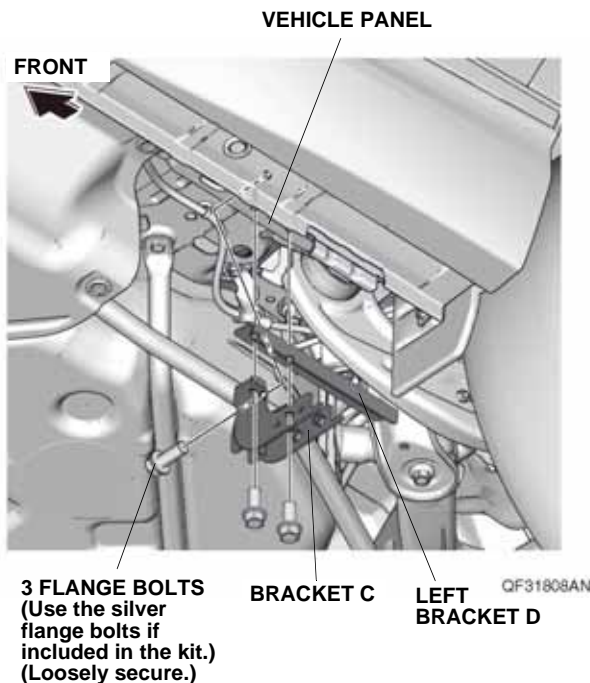

26. With the help of an assistant, loosely secure the left running board to bracket A, bracket B, bracket C, and left bracket D with 13 flange bolts.
 NOTE: If there are black and silver flange bolts in the kit, use six black flange bolts and seven silver flange bolts as shown.

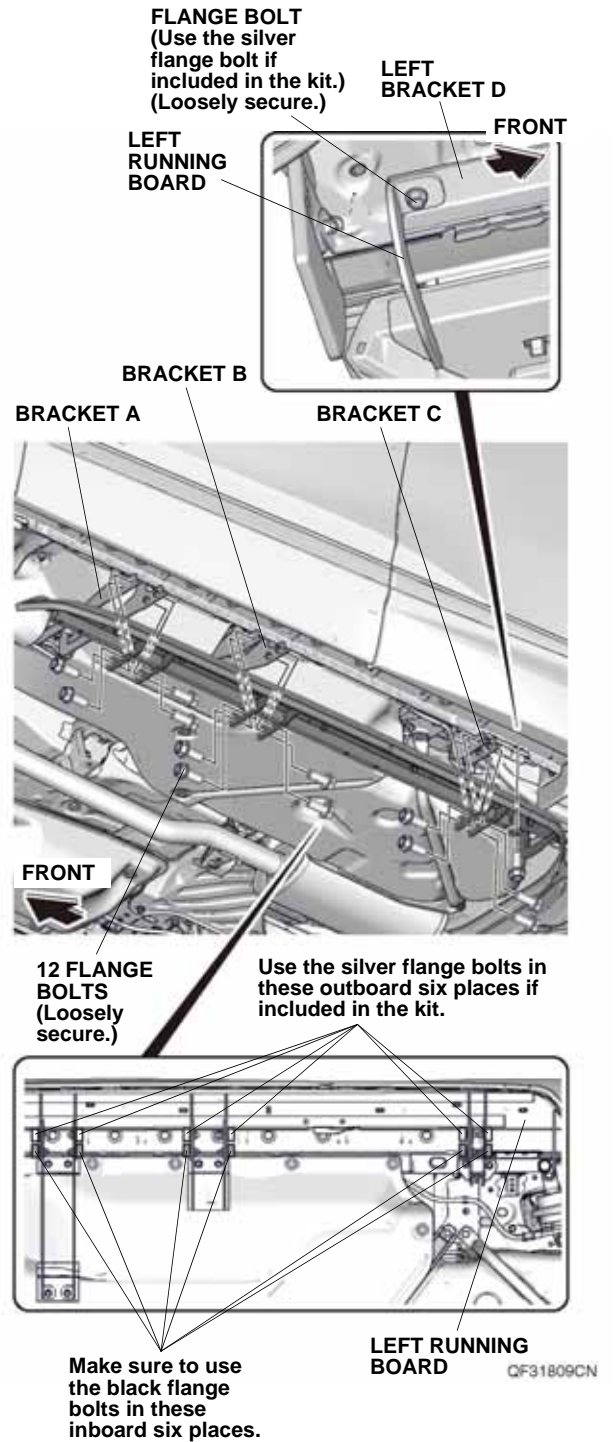

27. Secure bracket A, bracket B, and bracket C to the vehicle panel with nine flange bolts. Torque the flange bolts to 22 N-m (16 lb-ft).

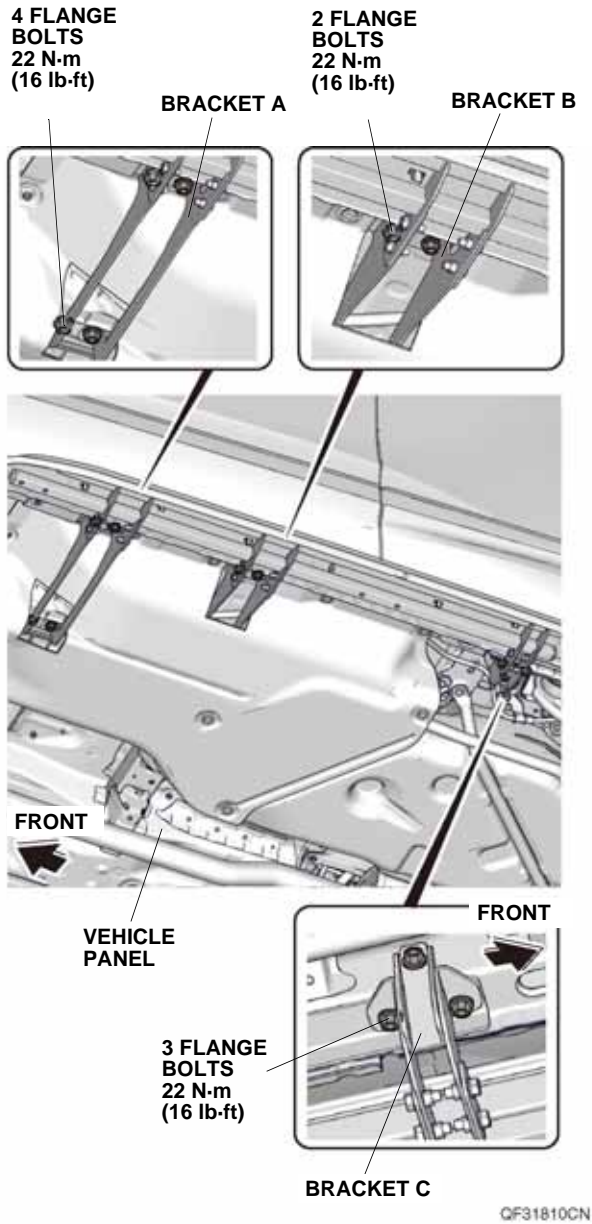

28. Secure the left running board to bracket A, bracket B, bracket C, and left bracket D with 13 flange bolts. Torque the flange bolts to 22 N-m (16 lb-ft).

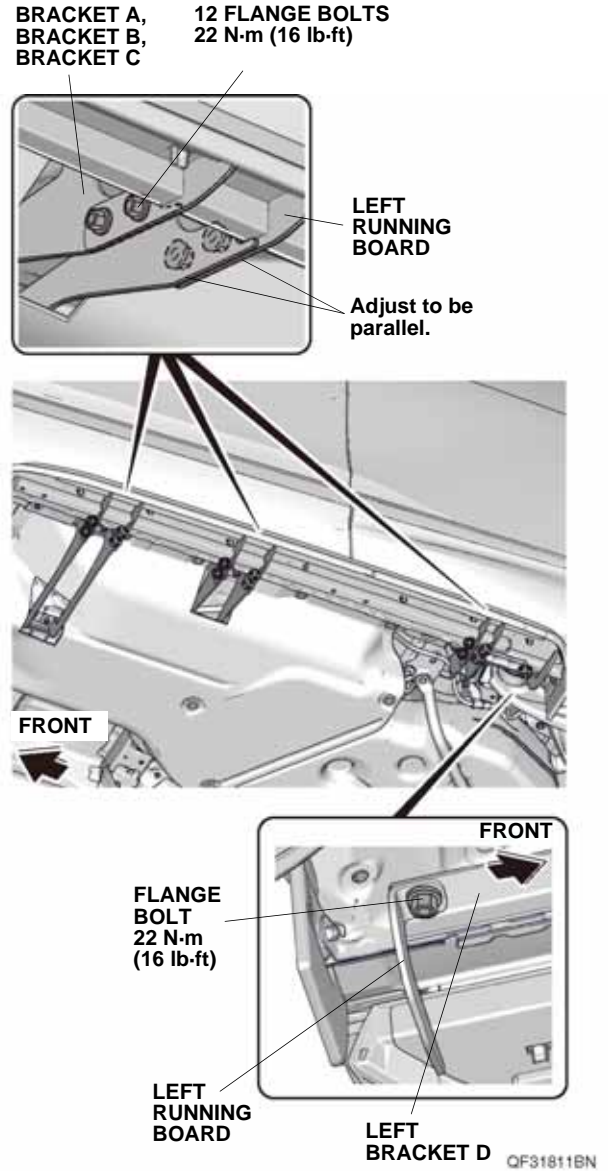

29. Repeat steps 24 through 28 on the right side of the vehicle.