



INSTALLATION INSTRUCTIONS

Accessory
EXHAUST PIPE FINISHER
 P/N 08F53-TLA-100

Application
2019 CR-V

Publications No.
VERSION 1

Issue Date
OCT 2018

PARTS LIST

Exhaust pipe finisher



Washer-bolt



TOOLS AND SUPPLIES REQUIRED

Ratchet

10 mm Socket

Torque wrench

Illustration of the Exhaust Pipe Finisher on the Vehicle

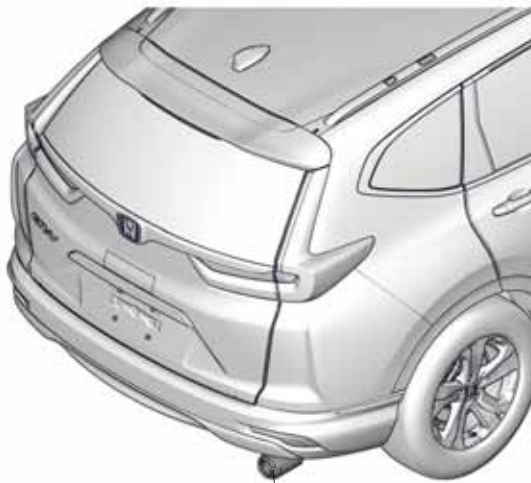

EXHAUST PIPE FINISHER

QF21901AA

INSTALLATION

Customer Information: The information in this installation instruction is intended for use only by skilled technicians who have the proper tools, equipment, and training to correctly and safely add equipment to your vehicle. These procedures should not be attempted by "do-it-yourselfers."

NOTE:

- Be careful not to damage the vehicle body and the parts of the vehicle.
- The exhaust pipe finisher is designed exclusively for the CR-V; it is not applicable to any other models.
- Allow the exhaust pipe to cool down before installing the exhaust pipe finisher.
- This instruction shows the exhaust pipe finisher being installed on the right exhaust pipe. An additional exhaust pipe finisher (sold separately) can be installed on the left exhaust pipe.

Installing the Exhaust Pipe Finisher

1. Slide the exhaust pipe finisher in until the projection of the exhaust pipe finisher contacts the end of the exhaust pipe.

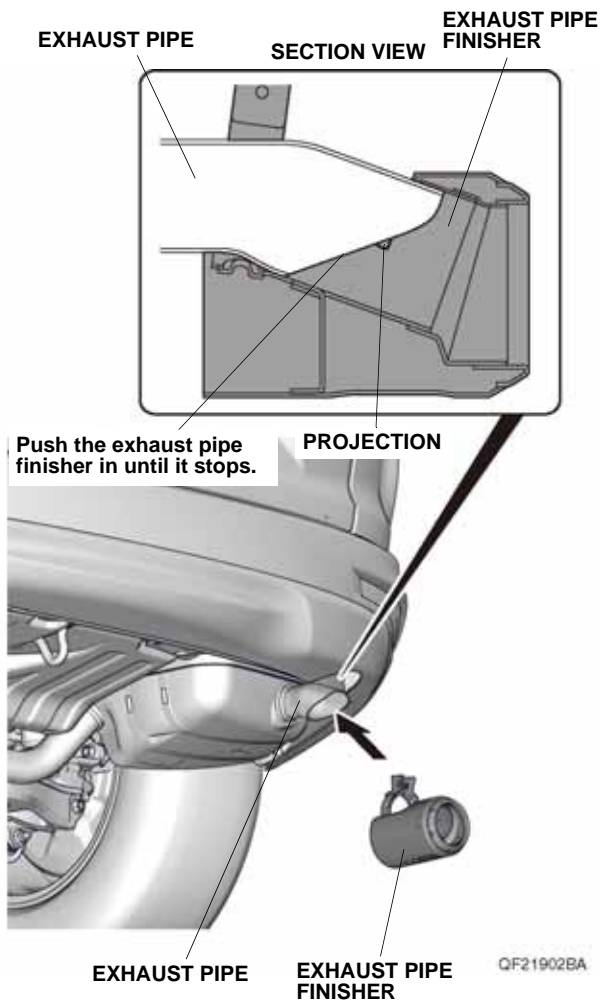

2. Thread one washer-bolt into the exhaust pipe finisher. While holding the exhaust pipe finisher firmly against the exhaust pipe, tighten the washer-bolt. Torque the washer-bolt to 10 N·m (7 lb·ft).

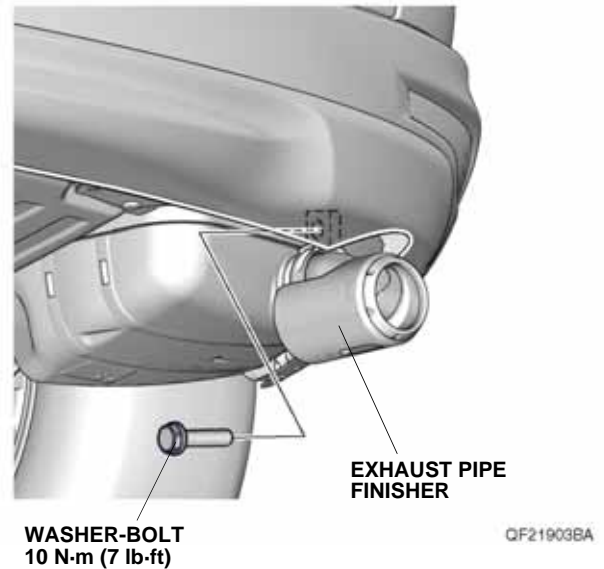

3. Start the engine, and rev it up a few times. Listen for vibration from the exhaust pipe finisher, and adjust if necessary.

USE AND CARE

Use a sponge or cloth and a solution of mild liquid dishwashing soap and water to clean the exhaust pipe finisher. Wax the exhaust pipe finisher using Honda Metal Polish (08C20-A021S). Never use a wax that contains abrasive material as it may scratch the surface.