



INSTALLATION INSTRUCTIONS

Accessory
ALL-SEASON FLOOR MATS
P/N 08P17-TLA-100
P/N 08P17-TLA-100A

Application
2019 CR-V

Publications No.
VERSION 1
Issue Date
OCT 2018

PARTS LIST

Driver's all-season floor mat



Passenger's all-season floor mat



Rear all-season floor mat



Illustration of the All-Season Floor Mats in the Vehicle

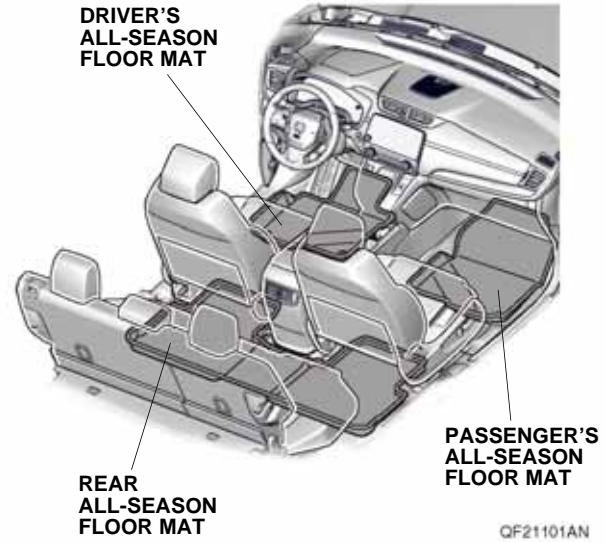

INSTALLATION

NOTE:

- Before installing the mats, identify their installation positions.
- Connect the mat to the anchors to prevent the mat from sliding forward and possibly interfering with the pedals.
- If you remove a mat, make sure you re-anchor it when you put it back in your vehicle.
- If you replace a mat, use a factory mat designed to be used with the anchors.
- If you use a non-factory mat in the driver's footwell, make sure it fits properly and that it can be used with the anchors.
- Do not put an additional mat on top of the anchored mat. An additional mat may slide forward and possibly interfere with the pedals.

Installing the All-Season Floor Mats

1. If equipped, remove the standard floor mats as described in the owner's manual.

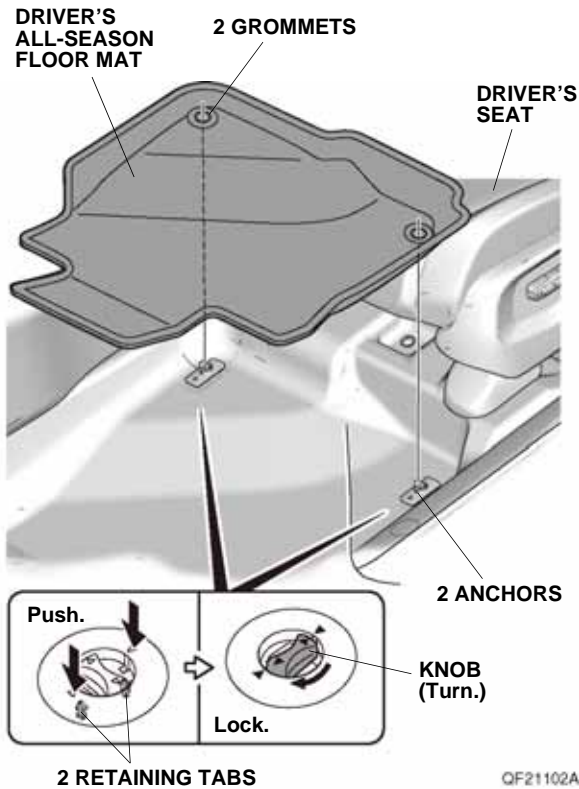

2. Place the grommets in the driver's all-season floor mat over the anchors. Push the grommets into the anchors to secure the retaining tabs, then turn the knobs 90° to secure the driver's all-season floor mat.

3. Place the passenger's all-season floor mat as shown.

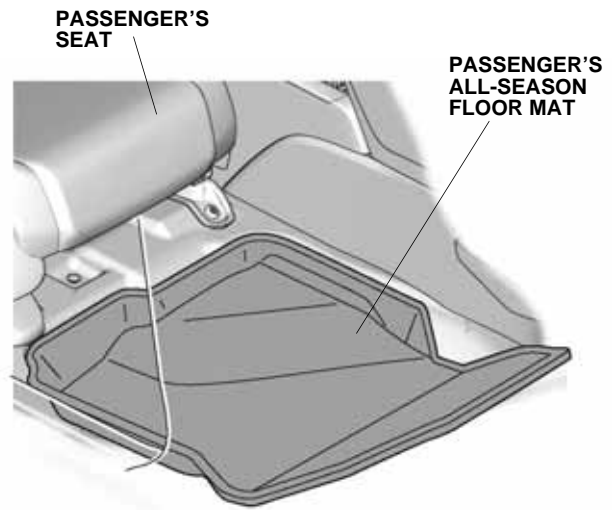

4. Place the rear all-season floor mat as shown.

