



## INSTALLATION INSTRUCTIONS

Accessory  
FRONT FENDER TRIMS  
P/N 08F59-TLA-100

Application  
2018 CR-V

Publications No.  
**VERSION 1**  
Issue Date  
OCT 2017

### PARTS LIST

Left front fender trim



Right front fender trim



Template



2 Alcohol swabs



### TOOLS AND SUPPLIES REQUIRED

Masking tape

*The following tool is available through the Honda Tool and Equipment Program. On the iN, click on Service > Service Bay > Tool and Equipment Program, then enter the number under "Search." Or, call 888-424-6857.*

Rubber Roller (T/N MHLE54D)

### Illustration of the Front Fender Trims on the Vehicle

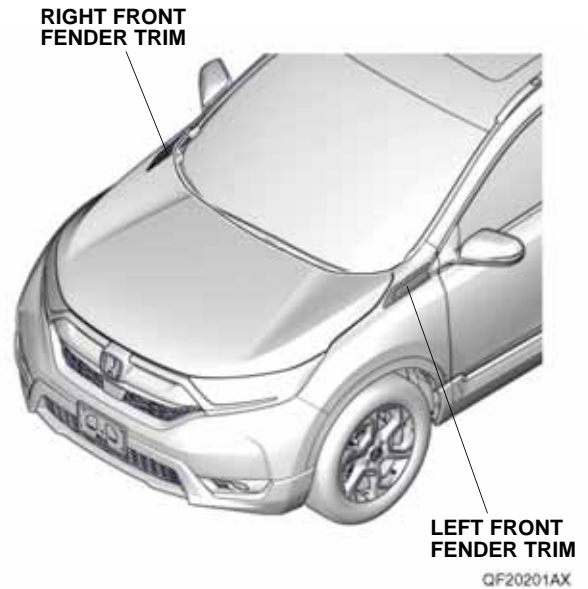

### INSTALLATION

**Customer Information:** The information in this installation instruction is intended for use only by skilled technicians who have the proper tools, equipment, and training to correctly and safely add equipment to your vehicle. These procedures should not be attempted by "do-it-yourselfers."

#### NOTE:

- Be careful not to damage the paint finish.
- This kit should be installed only if the ambient air temperature is 15°C (60°F) or above.
- To allow the adhesive to cure, do not wash the vehicle for 24 hours. Make sure your customer is aware of this.

1. Using an alcohol swab, thoroughly clean the left front fender where the left front fender trim will attach.

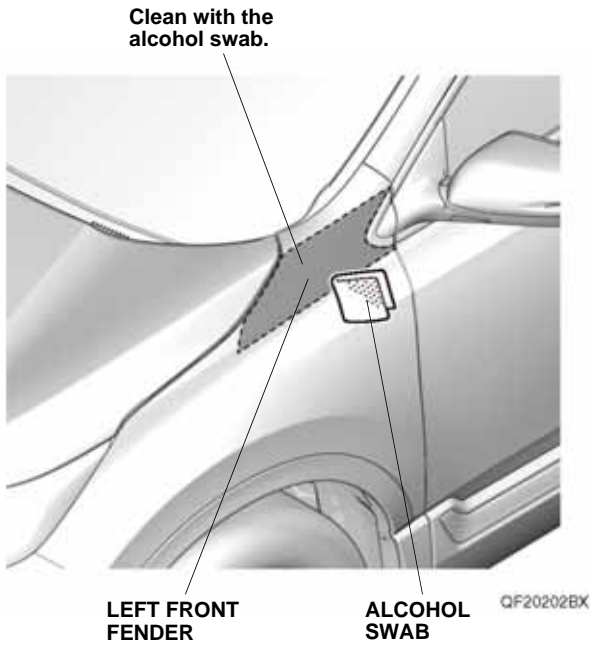

2. Fold the tab on the template. Line up the template with the character line, and attach it to the left front fender with masking tape as shown.

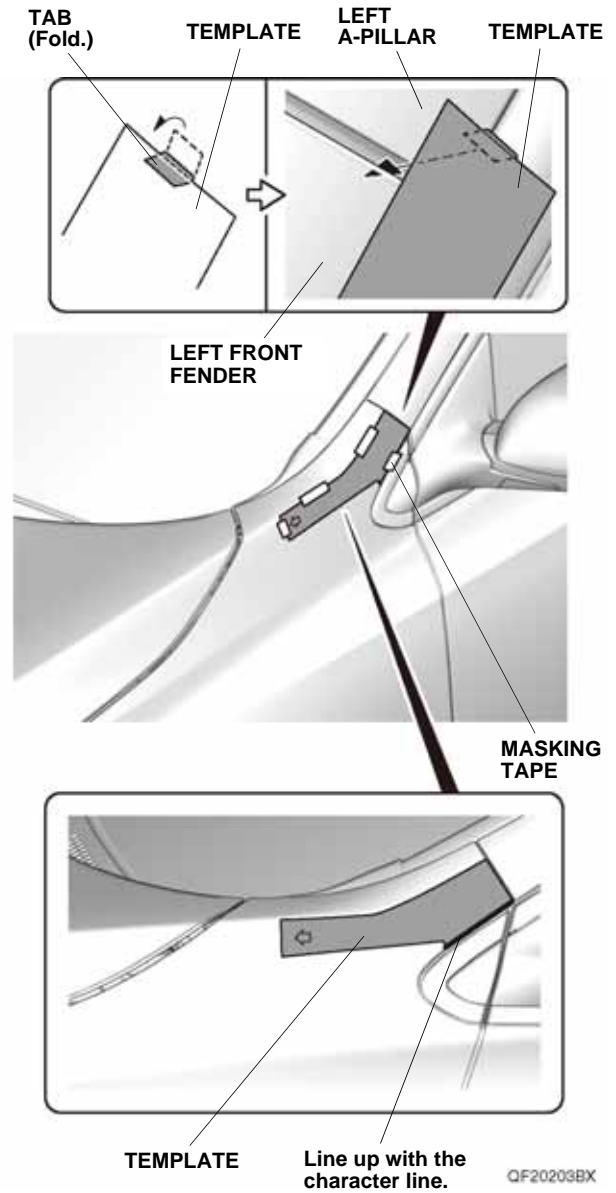

3. Peel back the adhesive backings, and tape them to the front surface of the left front fender trim with masking tape. Remove the remaining adhesive backings.

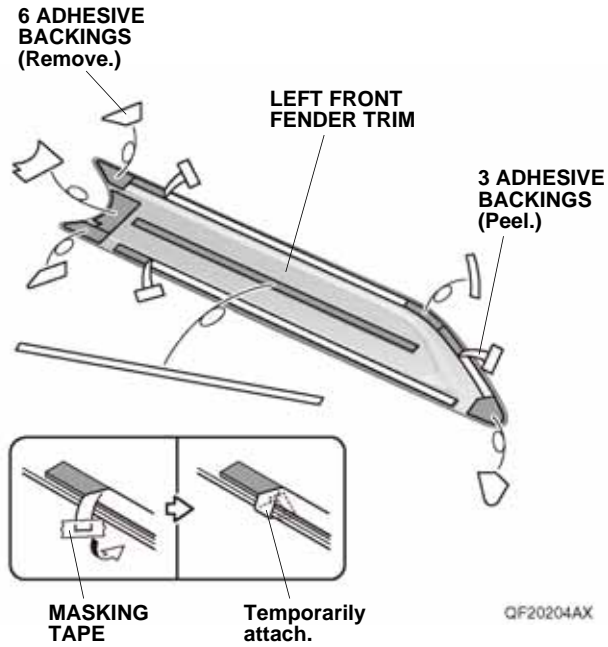

4. Line up the left front fender trim with the template, and attach it to the left front fender as shown.

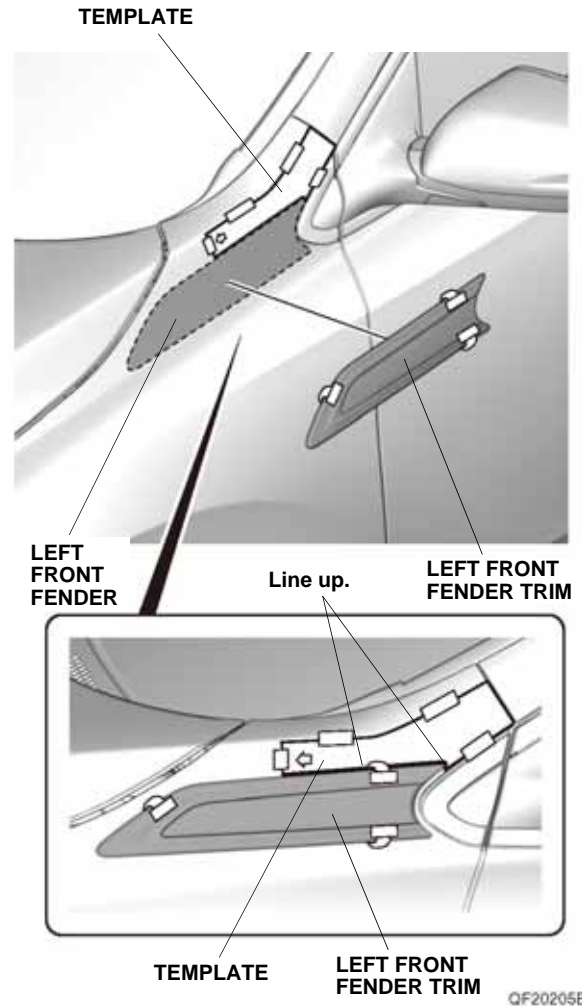

5. While applying light pressure against the left front fender trim, carefully remove the taped adhesive backings.

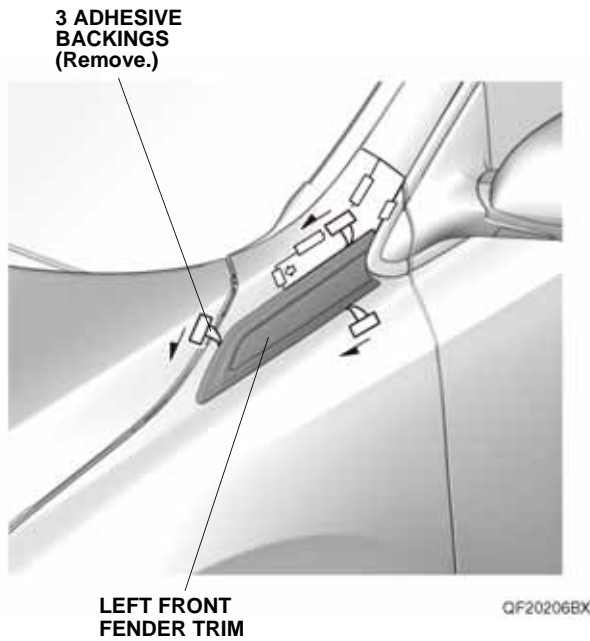

6. Using a rubber roller, apply firm pressure against the left front fender trim and roll from one end to the other. Apply firm pressure, especially at the ends.

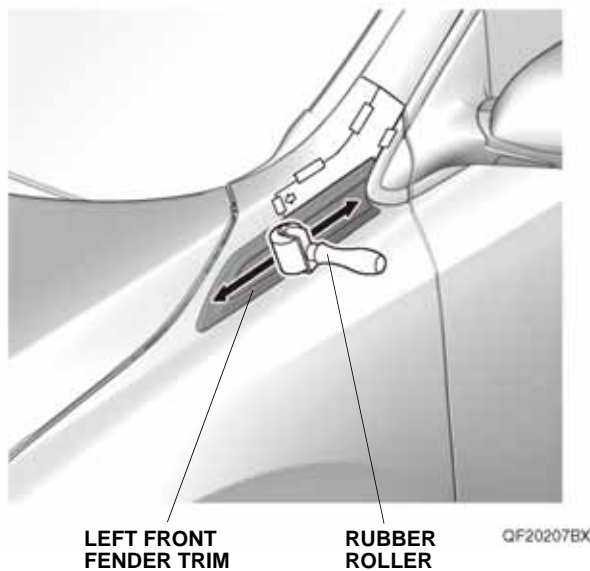

7. Remove the template. Turn the template over, and repeat steps 1 through 6 on the right side of the vehicle.