



**INSTALLATION  
INSTRUCTIONS**

Accessory  
**TRAILER HITCH**

Application  
**2009 CR-V**

Publications No.  
**All 40373**  
Issue Date  
**AUG 2008**

**PARTS LIST**

**Trailer Hitch Kit  
P/N 08L92-SWA-100**

Trailer hitch

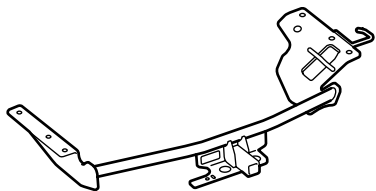

Ball mount

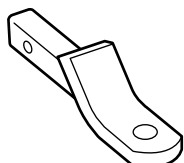

Center plate



6 Hex bolts, 10 x 40 mm

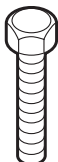

Hex bolt, 12 x 45 mm

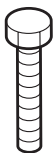

Hex nut, 12 mm



6 Plain washers, 10 mm



Plain washer, 12 mm



6 Spring washers, 10 mm



Spring washer, 12 mm



Hitch pin

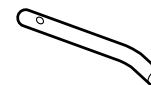

Hitch pin clip



Receiver cover

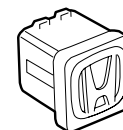

Template

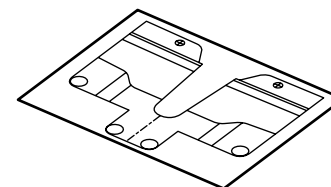

Spacer (If equipped, not used)



**Trailer Hitch Harness Kit**  
**P/N 08L91-SWA-100**

Trailer fuse harness

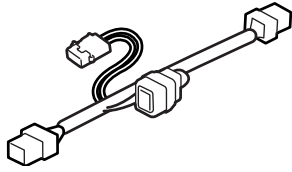

Control unit harness

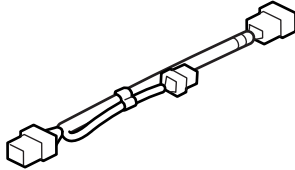

Trailer socket harness

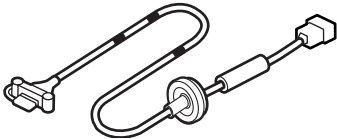

Control unit bracket

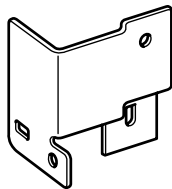

Control unit

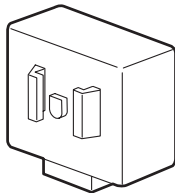

2 Flange bolts, 6 x 40 mm



Flange bolt, 6 x 16 mm



2 Flange nuts, 6 mm



2 Harness tapes

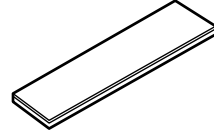

8 Wire ties

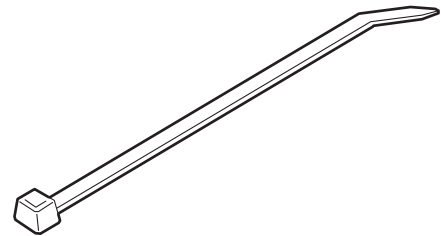

3 Wire ties with clip

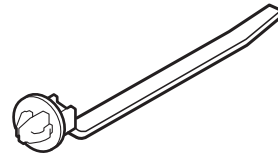

Connector clip



Fuse (5 A)

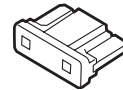

Fuse label

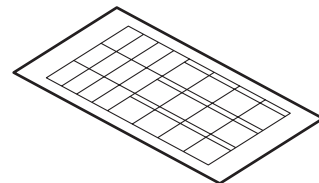

Accessory User's Information Manual

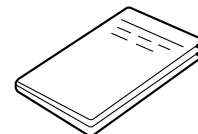

## TOOLS AND SUPPLIES REQUIRED

Phillips screwdriver  
Flat-tip screwdriver  
Ratchet  
5 mm, 6 mm, 10 mm, 12 mm, and 19 mm Sockets  
Utility knife  
Clip remover  
Diagonal cutters  
Scissors  
Torque wrench  
Drill  
3 mm Drill bit  
20 mm Hole saw  
Blanket  
Eye protection (safety goggles, face shield, etc.)  
Isopropyl alcohol  
Shop towel  
Hack saw blade  
Felt-tip pen  
Tape  
Pushpin

### *Illustration of the Trailer Hitch Installed on the Vehicle*

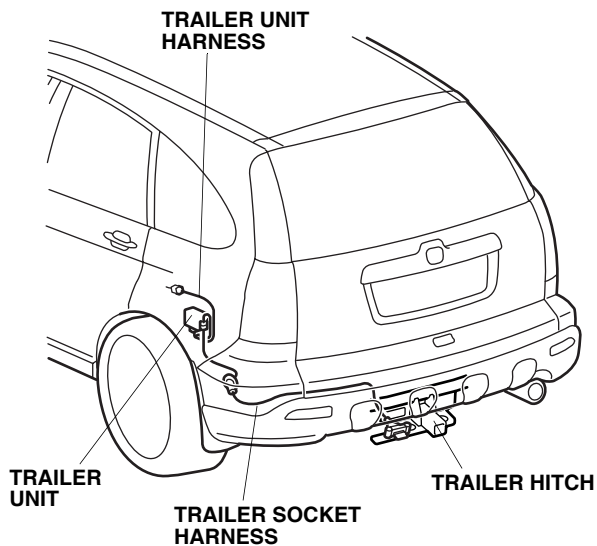

## INSTALLATION

**Customer Information:** The information in this installation instruction is intended for use only by skilled technicians who have the proper tools, equipment, and training to correctly and safely add equipment to your vehicle. These procedures should not be attempted by "do-it-yourselfers."

1. Make sure you have the anti-theft codes for the audio and navigation systems (if equipped), and write down the XM radio presets (if equipped).
2. Disconnect the negative cable from the battery.
3. Fold the rear seat forward.
4. Remove the rear door sill trim (three clips).

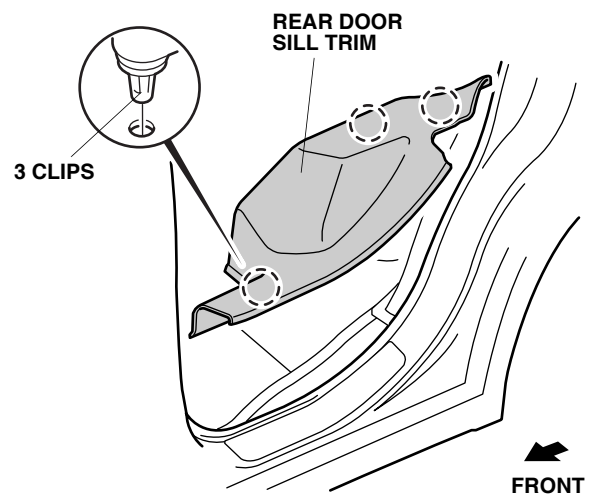

5. Remove the cargo area floor (two hooks).

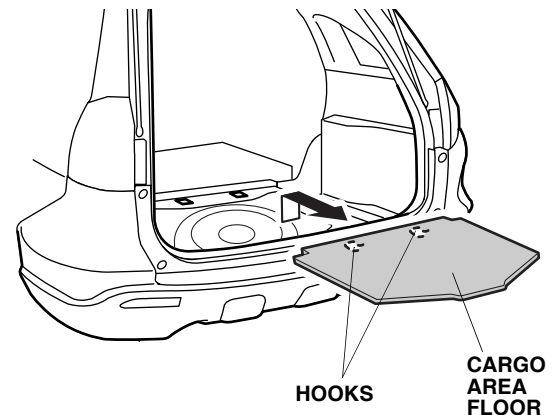

- Remove the two cargo tie-down hooks (two vehicle bolts).

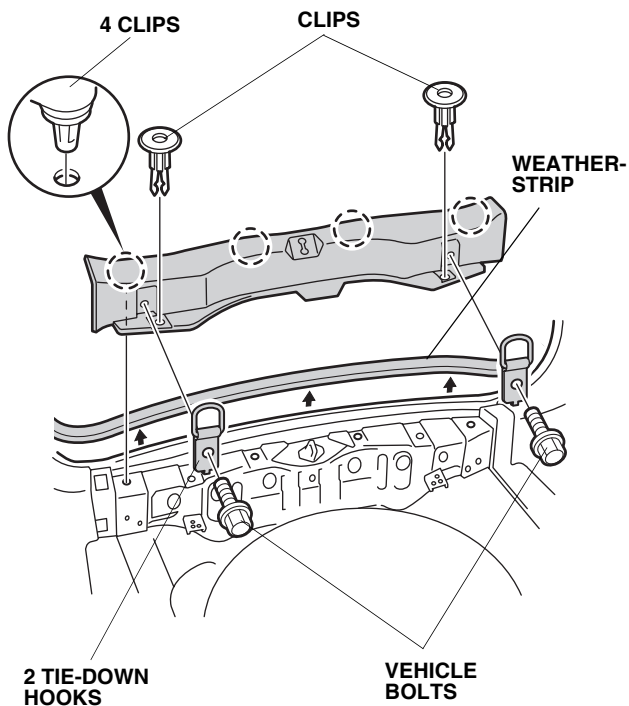

- Pull back the weatherstrip from around the rear trim panel, and remove the rear trim panel (four clips and two clips).
- Remove the lid from the left cargo area side trim panel (eight retaining tabs and one bolt).

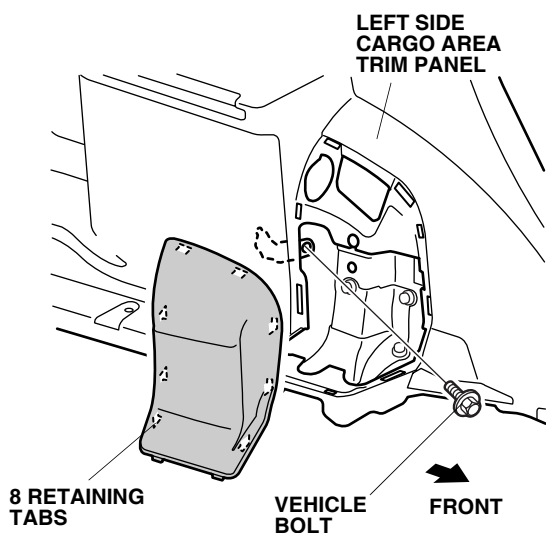

- Remove the rear door and tailgate weatherstrip from the left side rear door, and remove the washer bolt and the two clips from the trim panel.

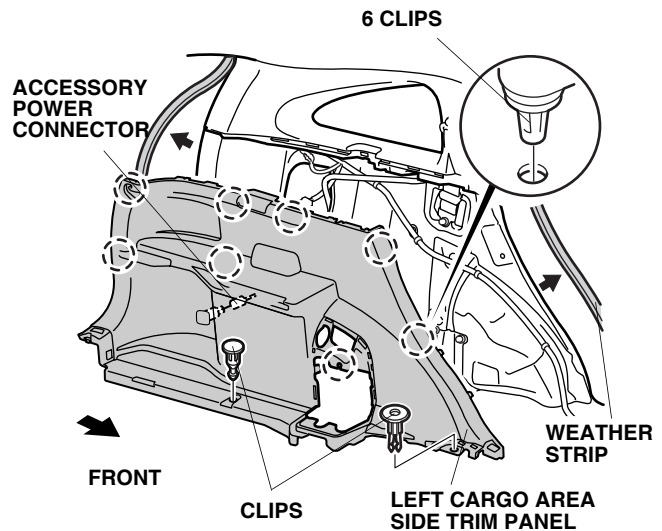

- Remove the left cargo area side trim panel (ten clips).
- Remove the drain hose from the two vehicle hooks.

