



INSTALLATION INSTRUCTIONS

Accessory	Application	Publications No.
FLOOR MATS P/N 08P15-TGH-100A	2021 CIVIC TYPE R	VERSION 1
		Issue Date AUG 2020

PARTS LIST

Driver's floor mat

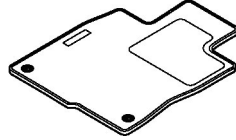

Passenger's floor mat

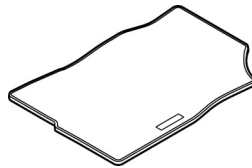

Left rear floor mat

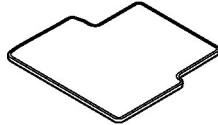

Right rear floor mat

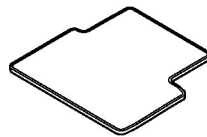
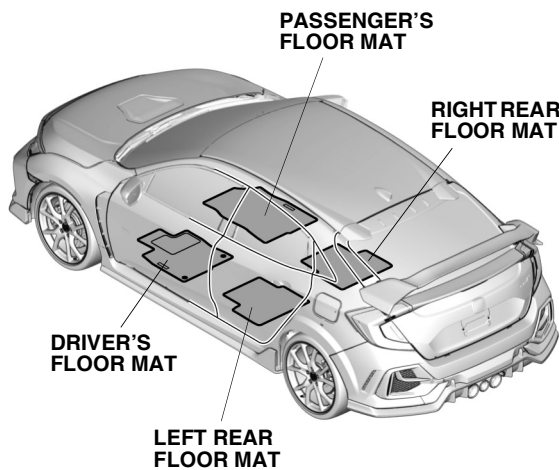

Illustration of the Floor Mats Installed in the Vehicle



QJ11301BR

INSTALLATION

NOTE:

- Before installing the mats, identify their installation positions.
- Connect the driver's mat to the anchors to prevent the mat from sliding forward and possibly interfering with the pedals.
- If you remove the driver's mat, make sure you re-anchor it when you put it back in your vehicle.
- If you replace the driver's mat, use a factory mat designed to be used with the anchors.
- If you use a non-factory mat in the driver's footwell, make sure it fits properly and that it can be used with the anchors.
- Do not put an additional mat on top of the anchored mat. An additional mat may slide forward and possibly interfere with the pedals.

Installing the Floor Mats

1. Remove the floor mats as described in the owner's manual.

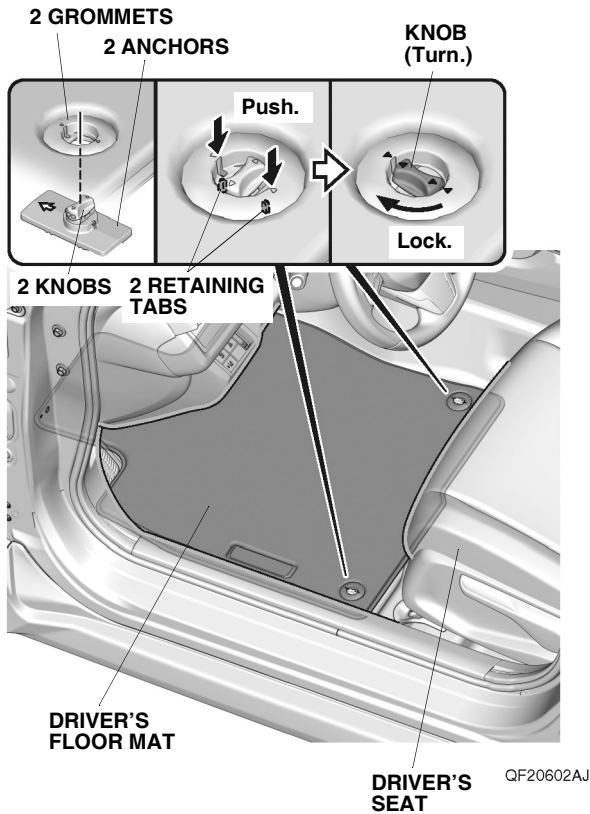

2. Place the grommets in the driver's floor mat over the anchors. Push the grommets into the anchors to secure the retaining tabs, then turn the knobs 90° to secure the floor mat.

3. Place the passenger's floor mat as shown.

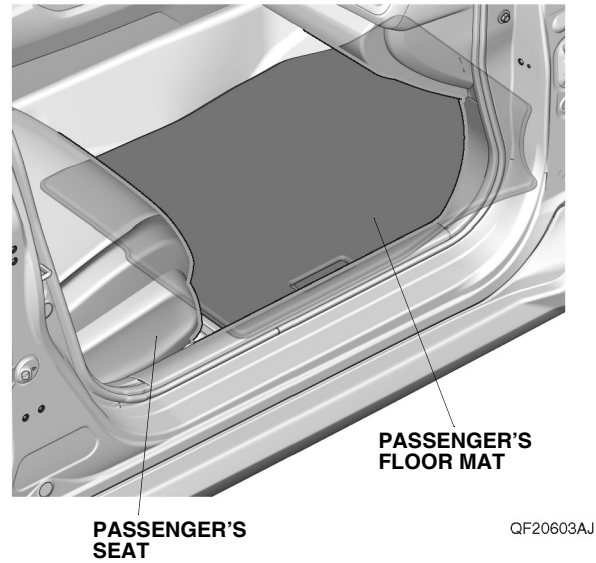

4. Place the left and right rear floor mats as shown.

