



INSTALLATION INSTRUCTIONS

Accessory

TAILGATE SPOILER
P/N 08F02-TEA-100A

Application

2020 CIVIC TYPE R

Publications No.

VERSION 1

Issue Date

FEB 2020

PARTS LIST

Center tailgate spoiler



2 Tailgate support struts



Left stopper



Right stopper



Left tailgate grip cover



Right tailgate grip cover



2 Bolts, 6 x 65 mm



2 TORX screws



4 Bolts, 6 x 12 mm



4 Washers



TOOLS AND SUPPLIES REQUIRED

Flat-tip screwdriver

10 mm Socket

Ratchet

Masking tape

T30 TORX bit

Phillips screwdriver

Torque wrench

The following tools are available through the Honda Tool and Equipment Program. On the iN, click on Service > Service Bay > Tool and Equipment Program, then enter the number under "Search." Or, call 888-424-6857.

- Trim Tool Set (T/N SOJATP2014)
- Plastic Trim Tool (T/N SILTRIMTL10)

Illustration of the Tailgate Spoiler Installed on the Vehicle

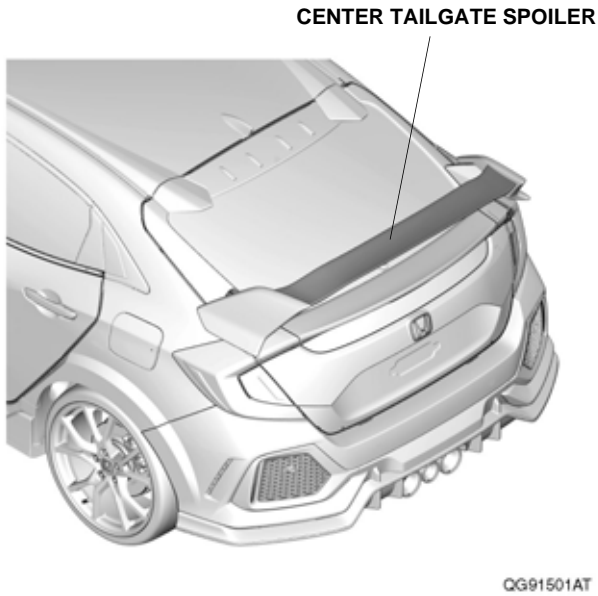

INSTALLATION

Customer Information: The information in this installation instruction is intended for use only by skilled technicians who have the proper tools, equipment, and training to correctly and safely add equipment to your vehicle. These procedures should not be attempted by “do-it-yourselfers.”

NOTE: Be careful not to damage the paint finish.

Removing the Vehicle Parts

1. Open the tailgate, and remove the rear cover.

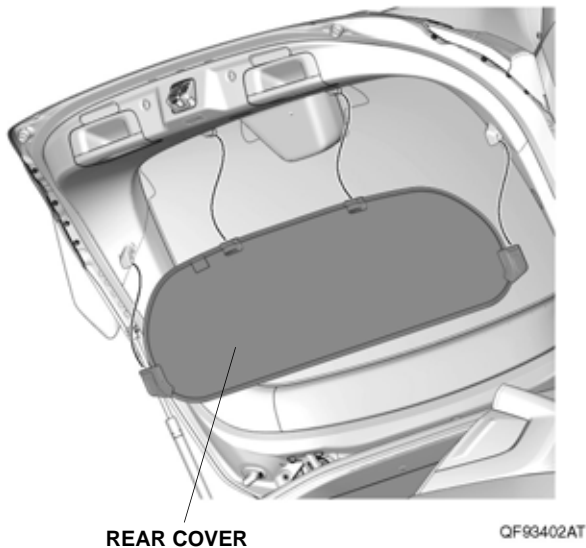

2. Remove the tailgate upper trim panel.

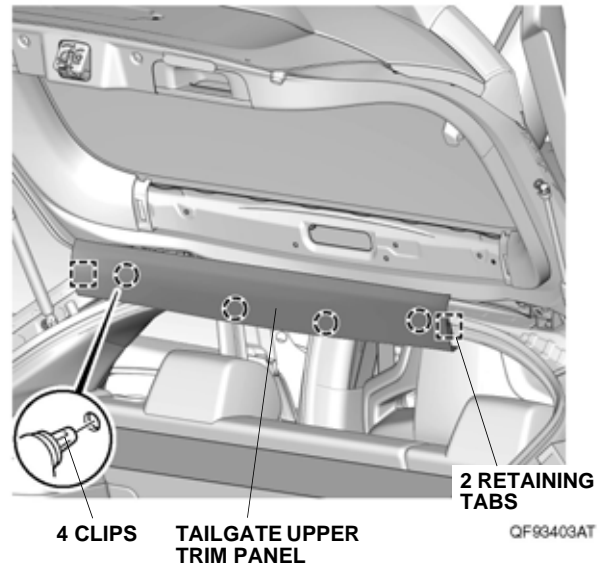

3. Remove the left and right tailgate side trim panels.

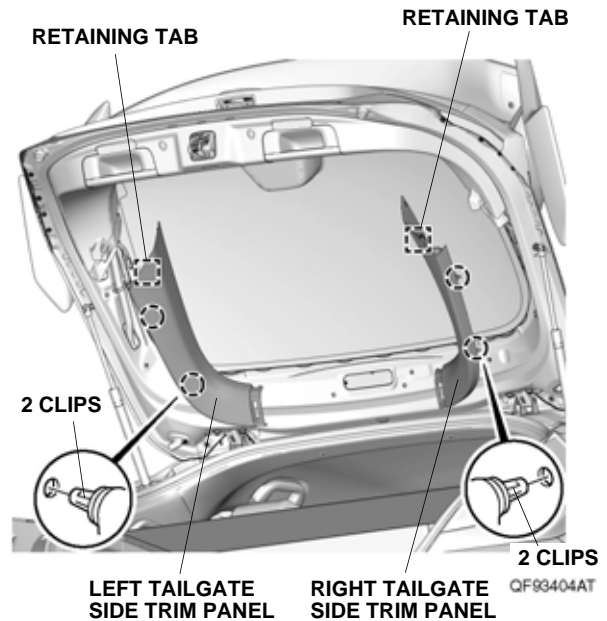

4. Remove the left and right stoppers.

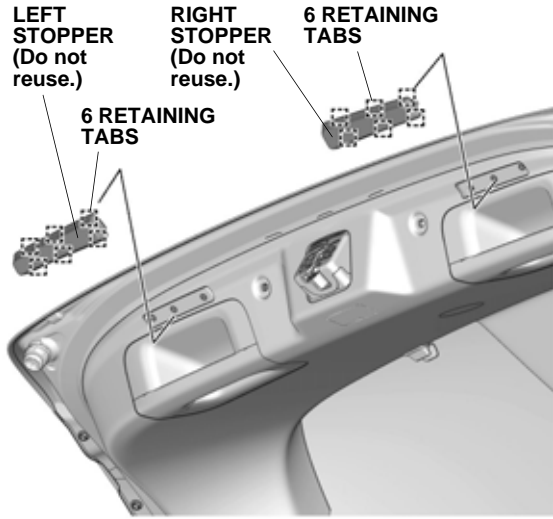

QF62130AT

5. Remove the left and right tailgate grip covers.

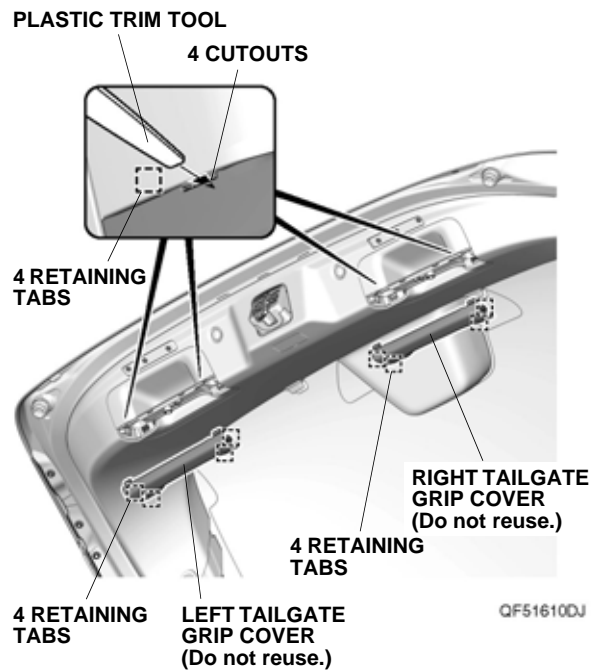

QF51610DJ

6. Remove the tailgate lower trim panel.

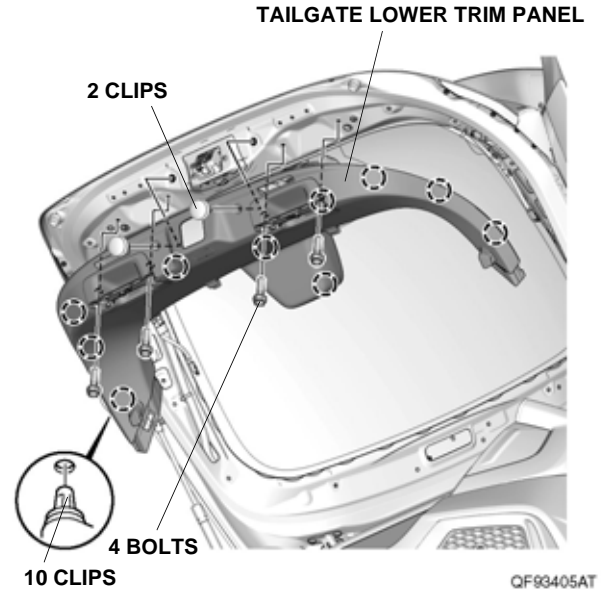

QF93405AT

Installing the Tailgate Spoiler

7. With the help of an assistant, remove the tailgate support strut.

- Wrap masking tape around the tip of a flat-tip screwdriver.
- Release the two support strut clips.

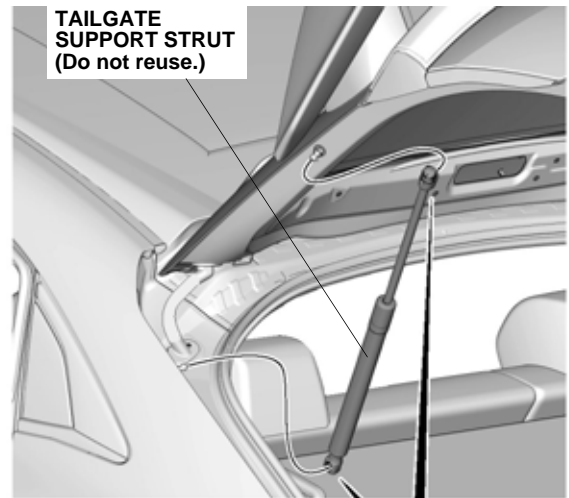

FLAT-TIP SCREWDRIVER

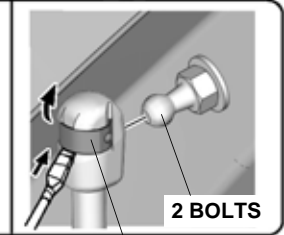
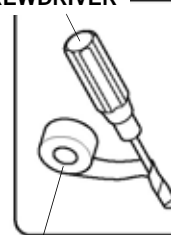

MASKING TAPE

2 SUPPORT STRUT CLIPS

QF93406CT

8. With the help of an assistant, install the new tailgate support strut to the two bolts.

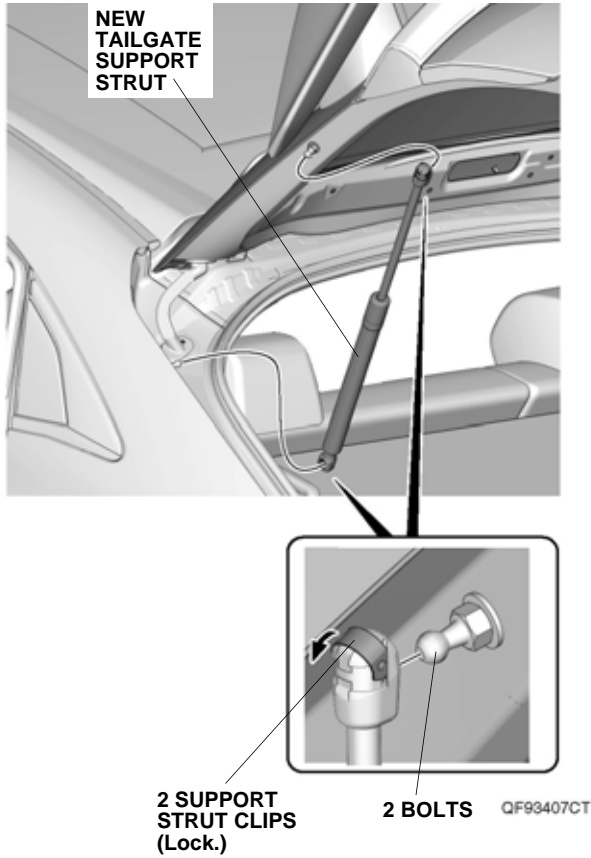

9. Repeat steps 7 and 8 to install the right side on the vehicle.

10. Apply masking tape as shown.

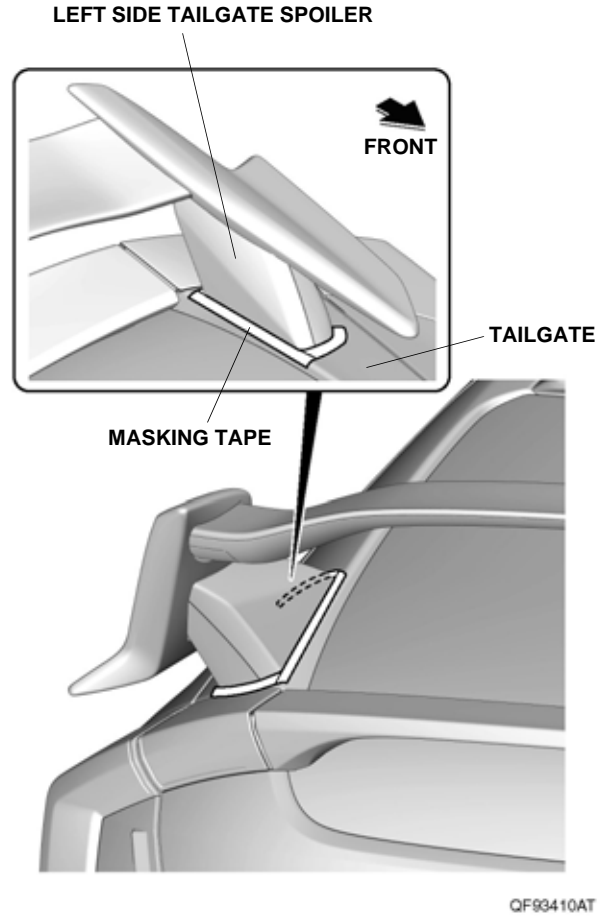

11. Remove the two bolts.

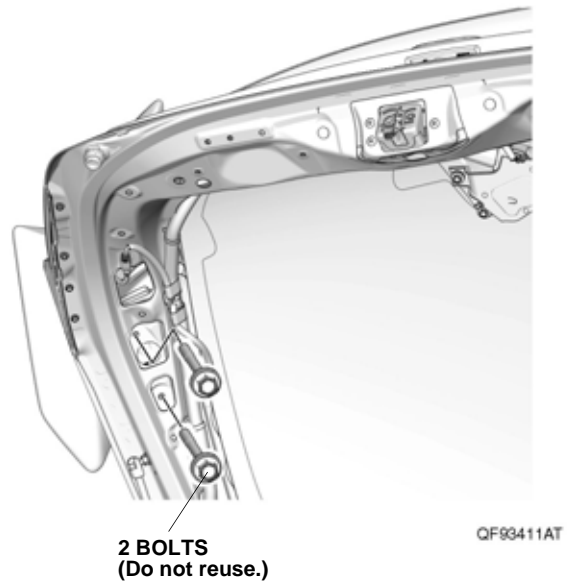

12. Close the tailgate, and remove the left and right covers.

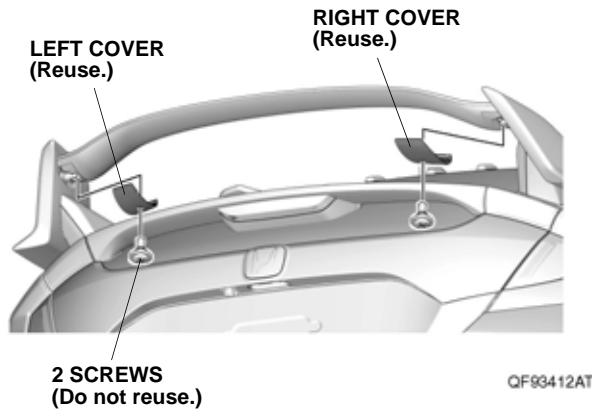

13. Remove the left side tailgate spoiler and center tailgate spoiler.

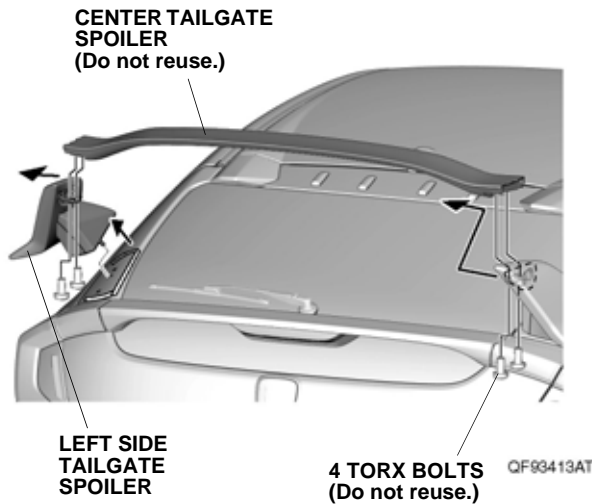

14. Loosely install the new center tailgate spoiler and left side tailgate spoiler as shown.

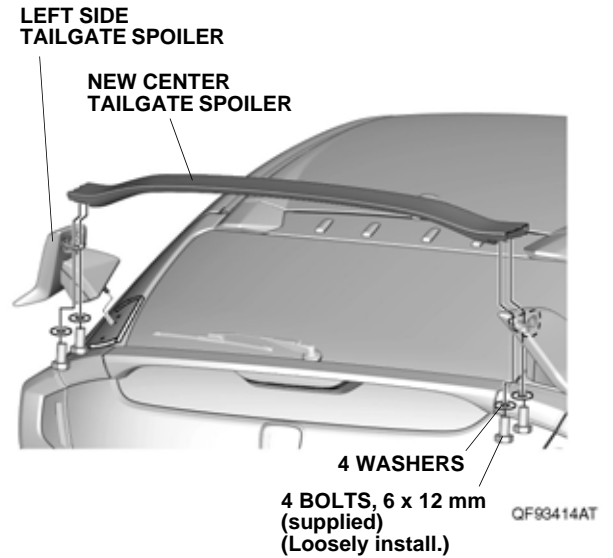

15. Open the tailgate, and secure the left side tailgate spoiler with two 6 x 65 mm bolts.

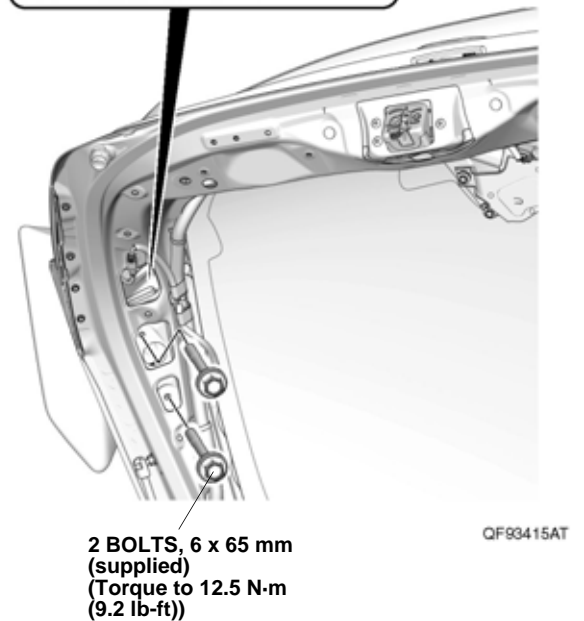
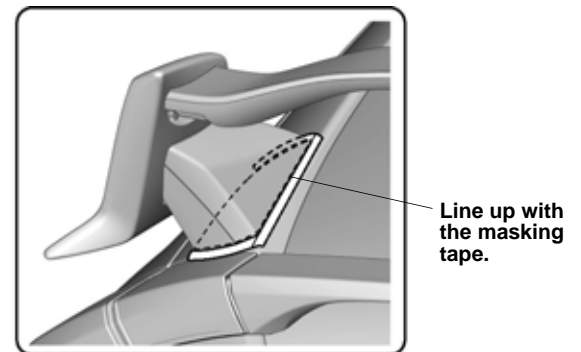

16. Remove the masking tape.

17. Tighten the four 6 x 12 mm bolts loosely installed in step 14.

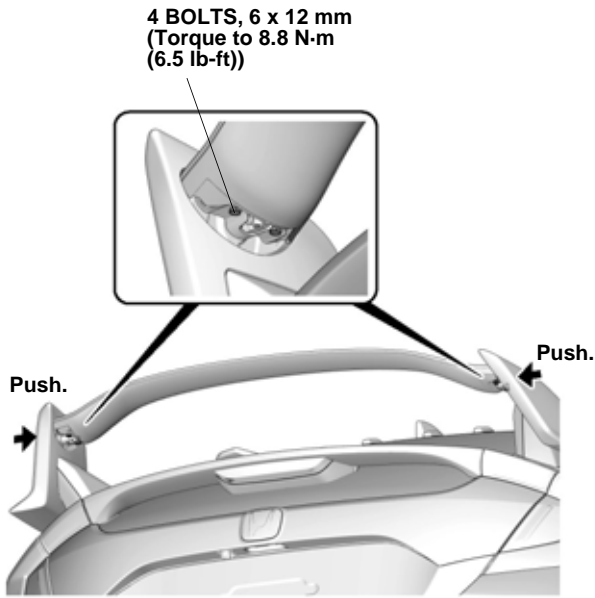

QF93416AT

18. Install the left and right covers to the new center tailgate spoiler with two TORX screws.

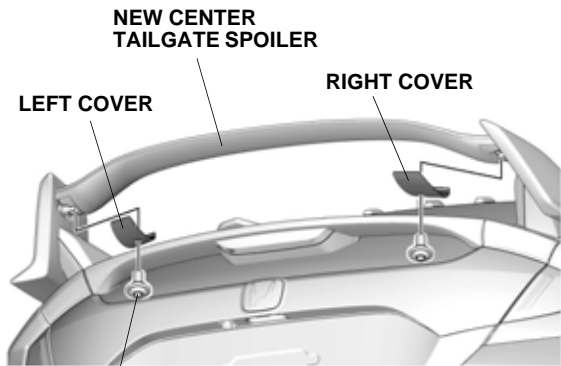

2 TORX SCREWS
(supplied)
(Torque to 5.0 N-m
(3.7 lb-ft))

QF93417AT

19. Install the tailgate lower trim panel.

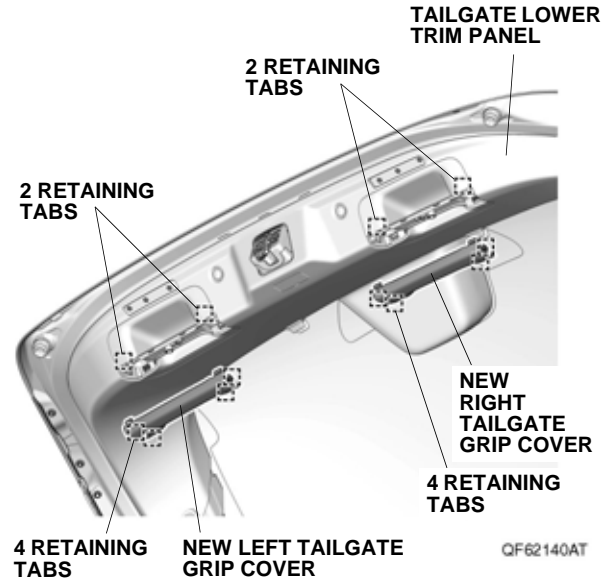

20. Install the new left and right tailgate grip covers to the tailgate lower trim panel.

21. Install the new left and right stoppers to the tailgate lower trim panel.

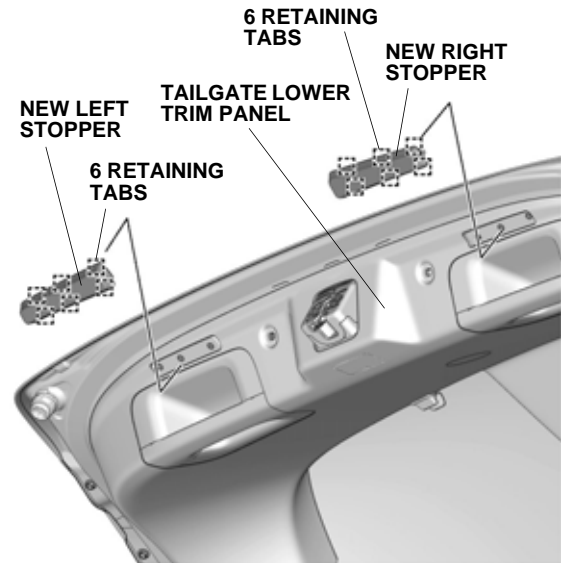

QF62130AT

22. Install all removed parts.