



INSTALLATION INSTRUCTIONS

Accessory
DOOR LOWER TRIMS
P/N 08F57-TGG-100

Application
2020 CIVIC
5-DOOR
(EXCEPT Si)

Publications No.
VERSION 1
Issue Date
AUG 2019

PARTS LIST

Left front door lower trim
(Identification mark: FR-L)



Right front door lower trim
(Identification mark: FR-R)



Left rear door lower trim
(Identification mark: RR-L)



Right rear door lower trim
(Identification mark: RR-R)



4 Alcohol swabs



TOOLS AND SUPPLIES REQUIRED

Masking tape

Ruler

The following tool is available through the Honda Tool and Equipment Program. On the iN, click on Service > Service Bay > Tool and Equipment Program, then enter the number under "Search." Or, call 888-424-6857.

- Rubber Roller (T/N MHLE54D)

Illustration of the Door Lower Trims Installed on the Vehicle

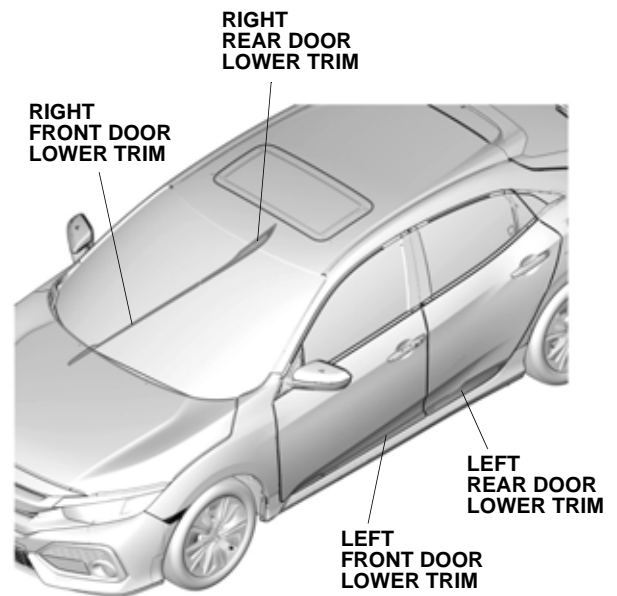

QF72301AT

INSTALLATION

Customer Information: The information in this installation instruction is intended for use only by skilled technicians who have the proper tools, equipment, and training to correctly and safely add equipment to your vehicle. These procedures should not be attempted by "do-it-yourselfers."

NOTE:

- Be careful not to damage the paint finish.
- This door lower trim kit should be installed only if the ambient air temperature is 15°C (60°F) or above.
- To allow the adhesive to cure, do not wash the vehicle for 24 hours. Make sure your customer is aware of this.

1. Apply masking tape to the left front door as shown.

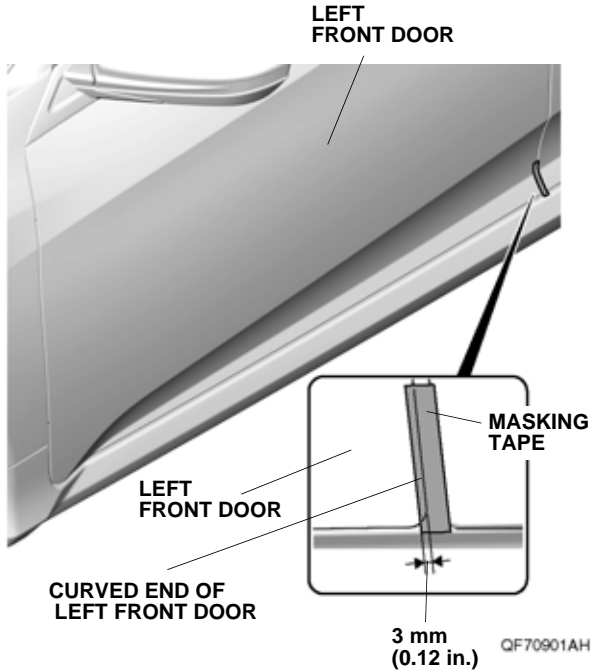

2. Using an alcohol swab, thoroughly clean the area where the left front door lower trim will attach.

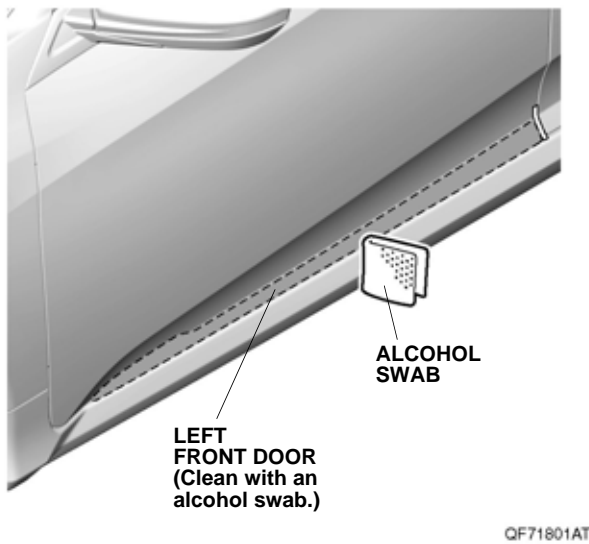

3. Peel back the adhesive backings, and tape them to the front surface of the left front door lower trim with masking tape. Remove the other adhesive backing.

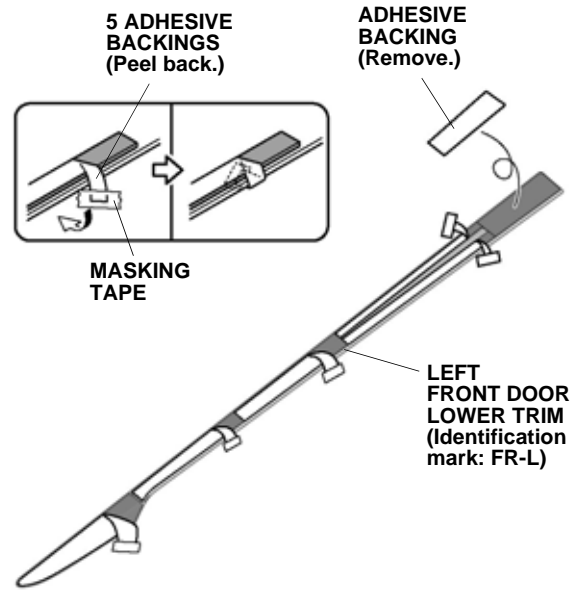

4. Line up the left front door lower trim as shown.

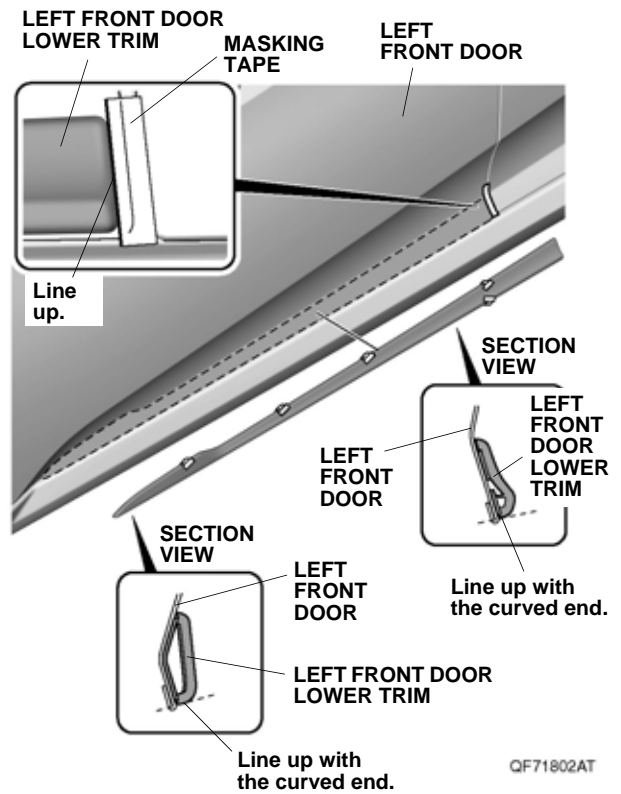

- While applying light pressure against the left front door lower trim, carefully remove the taped adhesive backings.

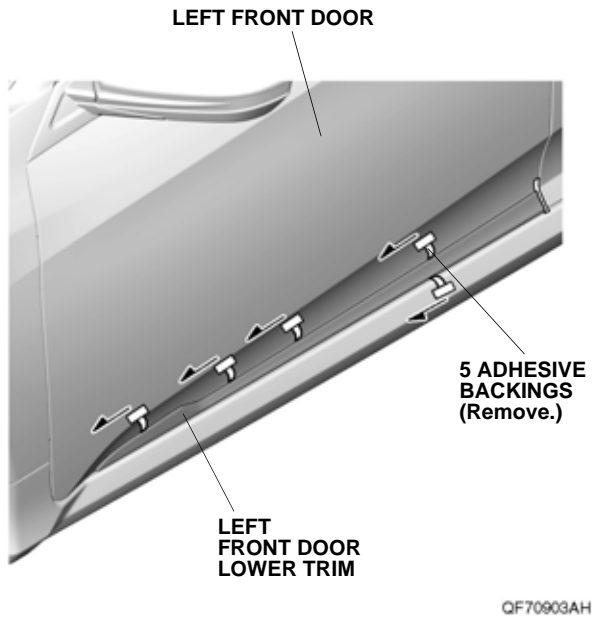

- Remove the masking tape.
- Using the rubber roller, apply firm pressure while rolling, especially at the ends, to set the adhesive.

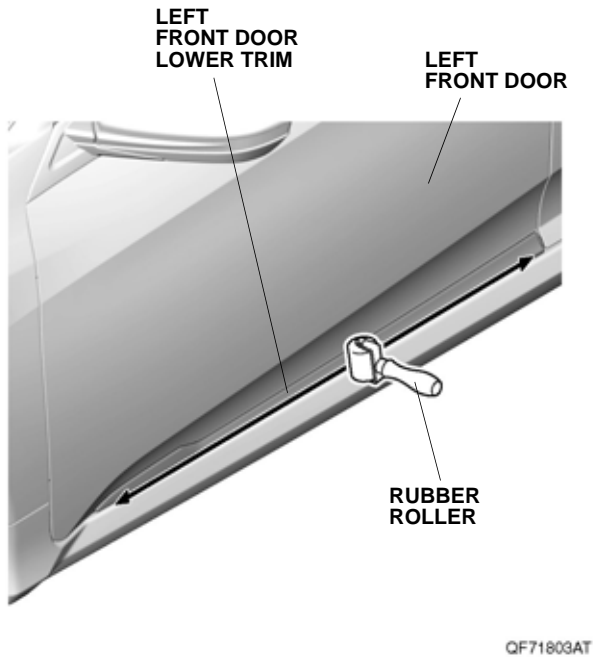

- Apply masking tape to the left rear door as shown.

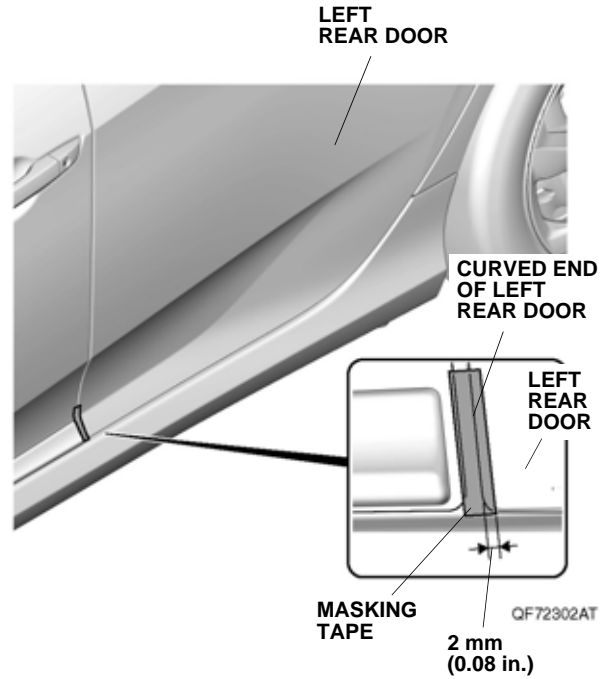

- Line up the left rear door lower trim as shown.

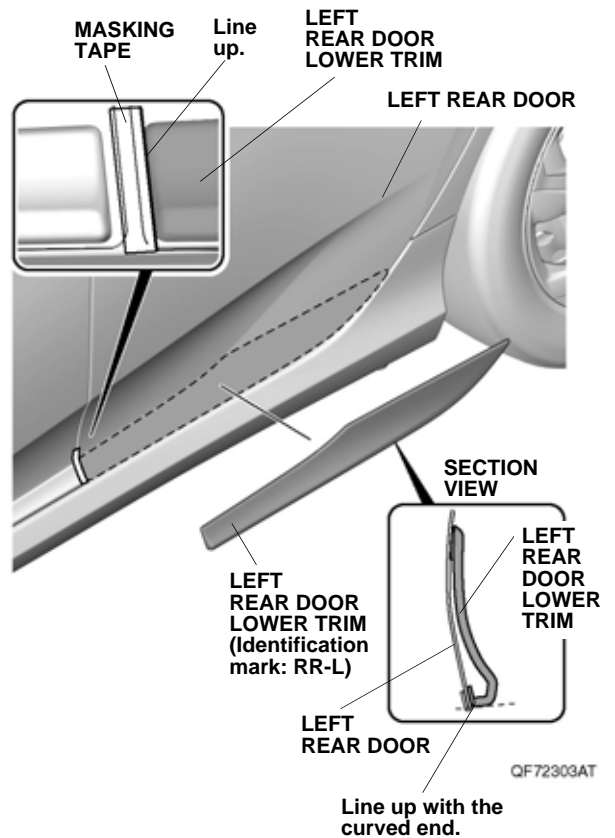

10. Apply masking tape to the left rear door as shown. Remove the left rear door lower trim.

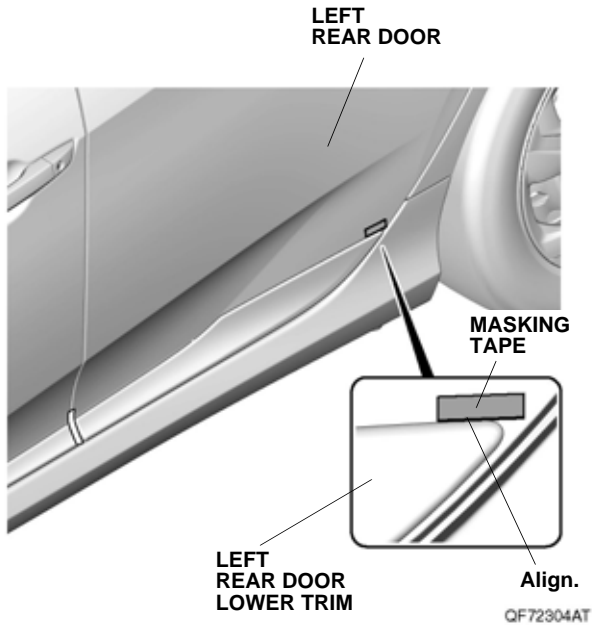

11. Using an alcohol swab, thoroughly clean the area where the left rear door lower trim will attach.

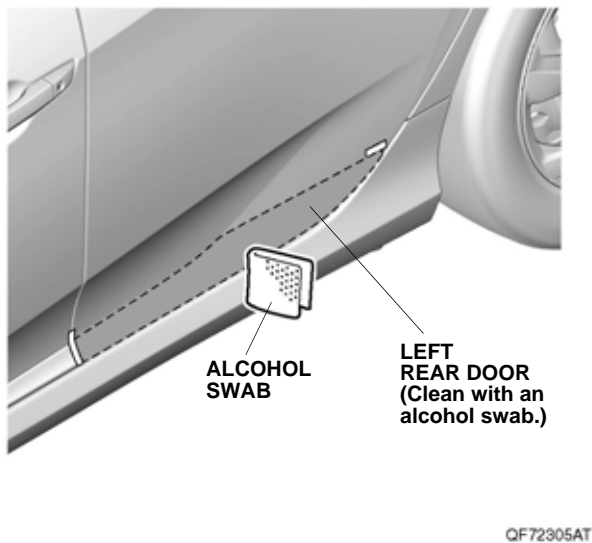

12. Peel back the adhesive backings, and tape them to the front surface of the left rear door lower trim with masking tape. Remove the other adhesive backings.

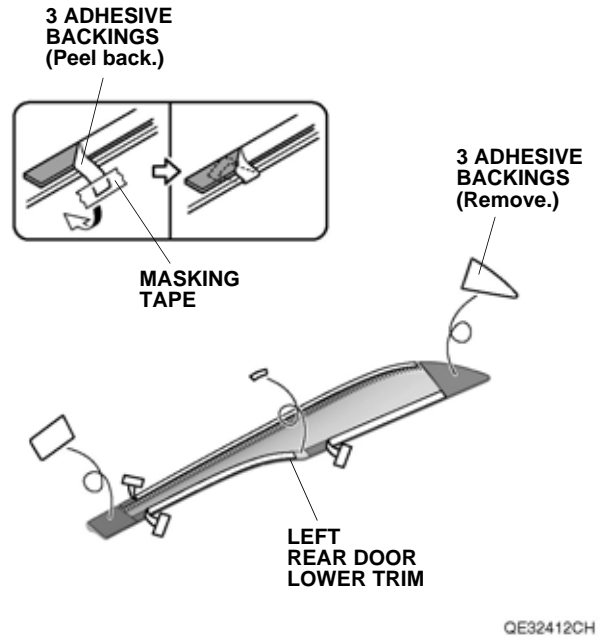

13. Line up the left rear door lower trim as shown.

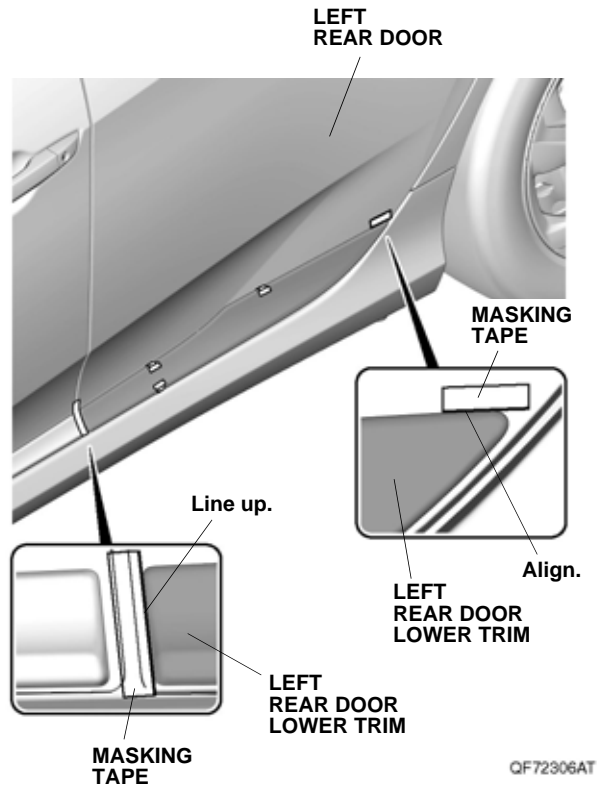

14. While applying light pressure against the left rear door lower trim, carefully remove the taped adhesive backings.

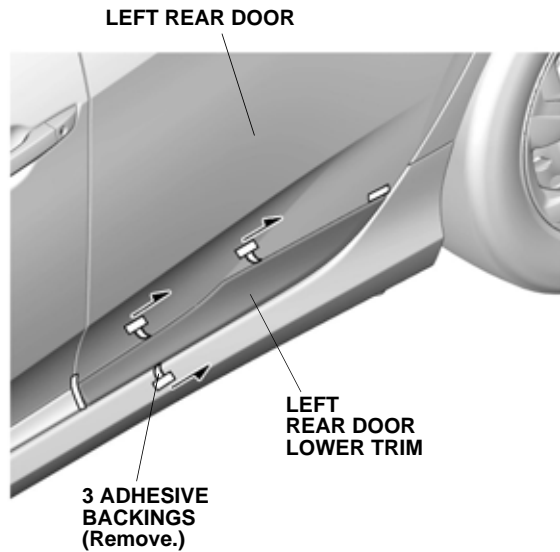

QF72307AT

15. Remove the masking tapes.
16. Using the rubber roller, apply firm pressure while rolling, especially at the ends, to set the adhesive.

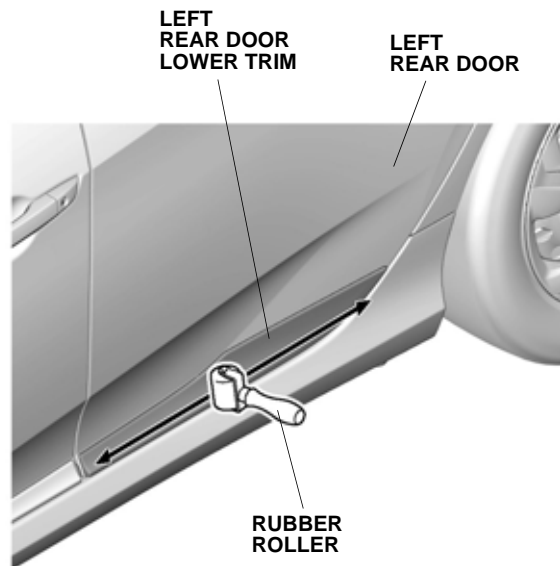

QE32414AH

17. Repeat steps 1 through 16 to install the right door lower trims.