



INSTALLATION INSTRUCTIONS

Accessory
DOOR VISORS
P/N 08R04-TGG-100A

Application
2020 CIVIC
5-DOOR
(EXCEPT Si)

Publications No.
VERSION 1
Issue Date
AUG 2019

PARTS LIST

Left front door visor



Right front door visor



Left rear door visor



Right rear door visor



8 Brackets



8 Clips



4 Alcohol swabs



TOOLS AND SUPPLIES REQUIRED

Masking tape
Ruler
Soft towel

INSTALLATION

Customer Information: The information in this installation instruction is intended for use only by skilled technicians who have the proper tools, equipment, and training to correctly and safely add equipment to your vehicle. These procedures should not be attempted by “do-it-yourselfers.”

NOTE:

- Visors may not be legal in all states. Please check the laws of your state.
- These instructions show the left door visors being installed. The same procedure applies to installing the right door visors.
- Be careful not to damage the body paint finish and glass run channels when installing the door visors.
- Handle the door visors with care. They are not designed to absorb shock or impact.
- This kit should be installed only if the ambient air temperature is 15°C (60°F) or above.
- To allow the adhesive to cure, do not wash the vehicle for 24 hours. Make sure your customer is aware of this.

Installing the Front Door Visors

1. Fully lower the left front door glass.

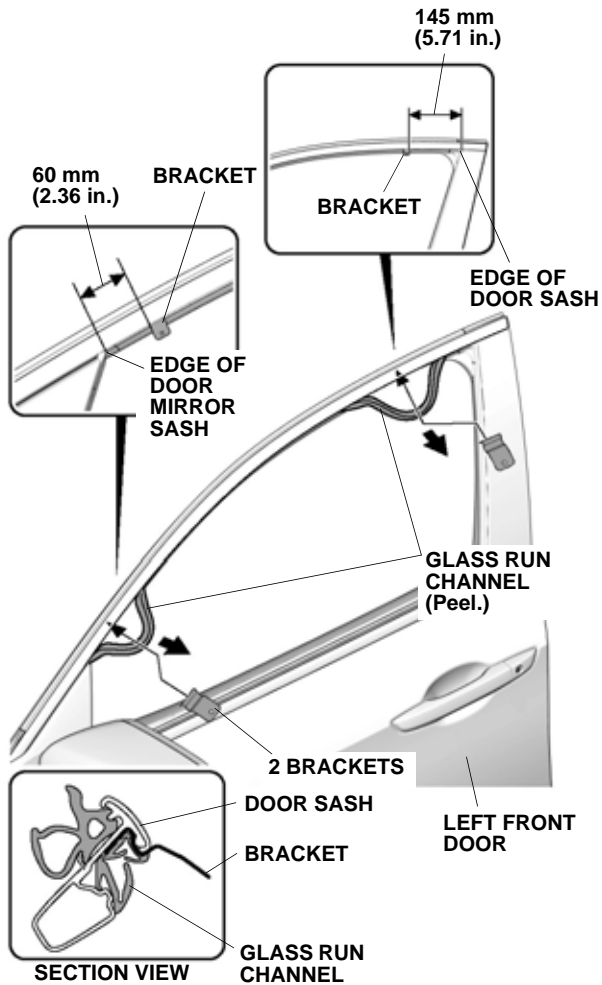

2. Peel the glass run channel as shown.
3. Install two brackets between the door sash and the glass run channel as shown. Seat the glass run channel properly around the brackets.

4. Using an alcohol swab, thoroughly clean the area where the left front door visor will attach.

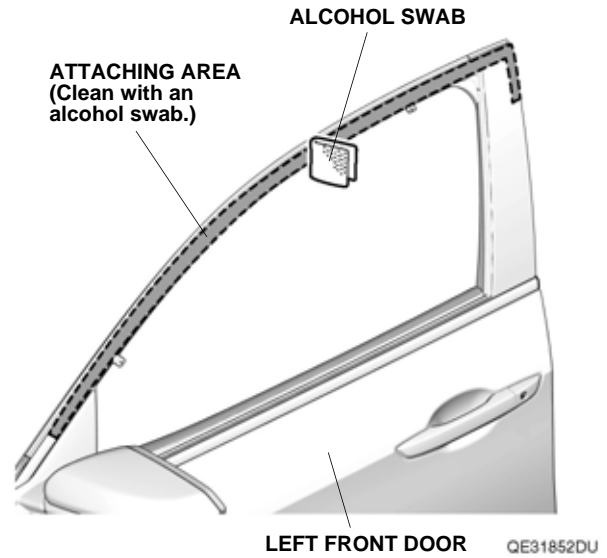

5. Peel back the adhesive backing from each adhesive tape and tape the ends to the front surface of the left front door visor with masking tape.

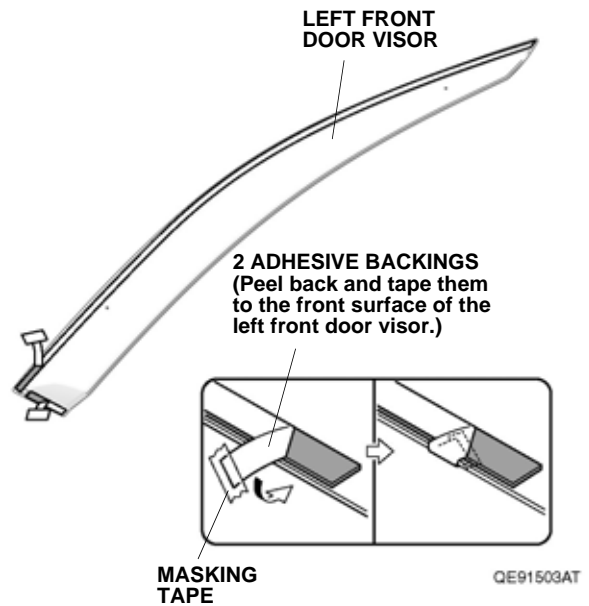

6. Line up each hole in the two brackets with the two holes in the left front door visor.

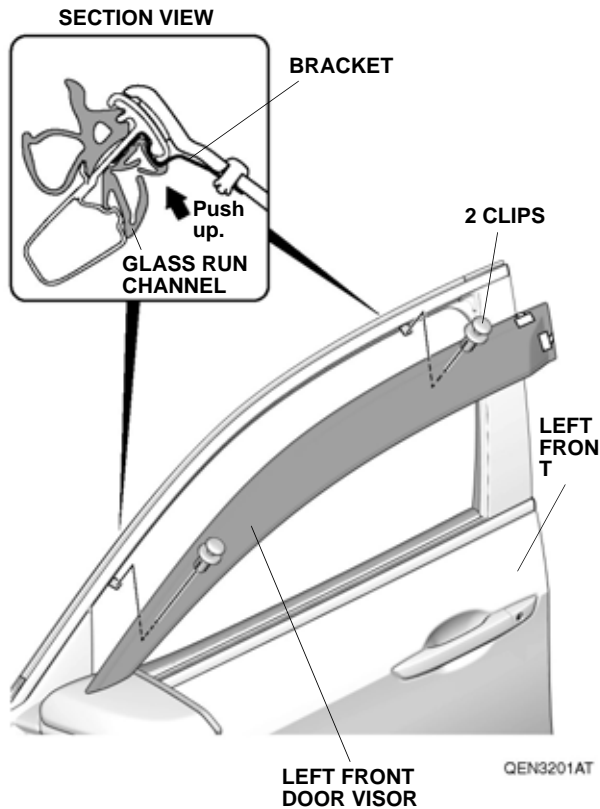

7. Secure the left front door visor to the two brackets with two clips. Make sure to push up on the brackets while installing the two clips.
NOTE: Be extremely careful when installing the clips; they cannot be reinstalled after installation.

8. Adjust the position of the left front door visor as shown.

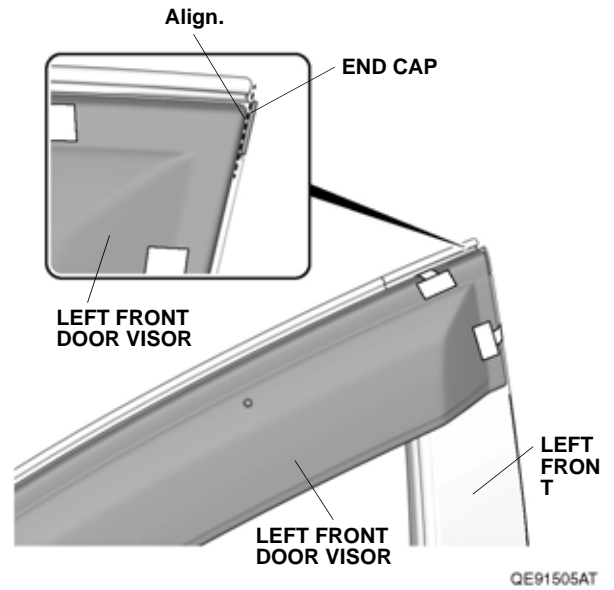

9. While applying light pressure against the left front door visor, carefully remove the adhesive backings in the order shown. Make sure to push up on the brackets while removing the adhesive backings.

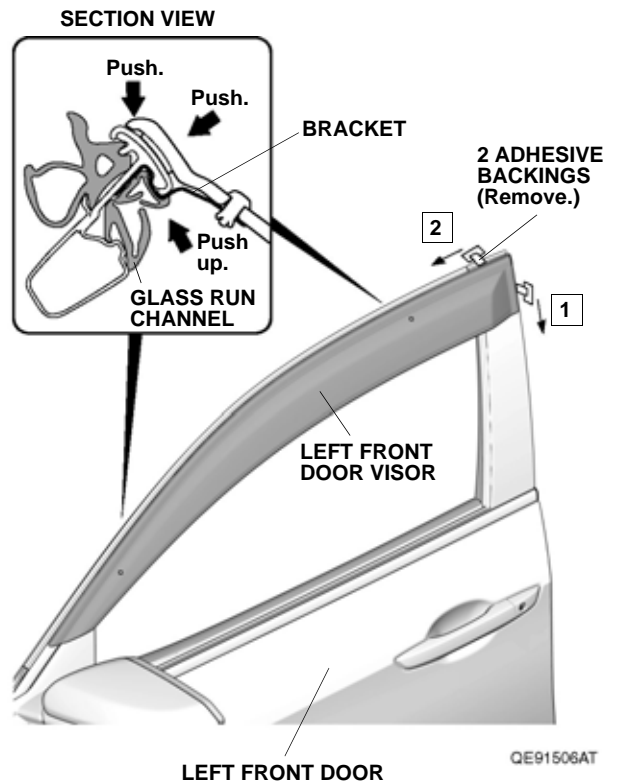

10. Using a soft towel, press and hold the left front door visor against the door sash for 30 seconds.

Installing the Rear Door Visors

11. Fully lower the left rear door glass.

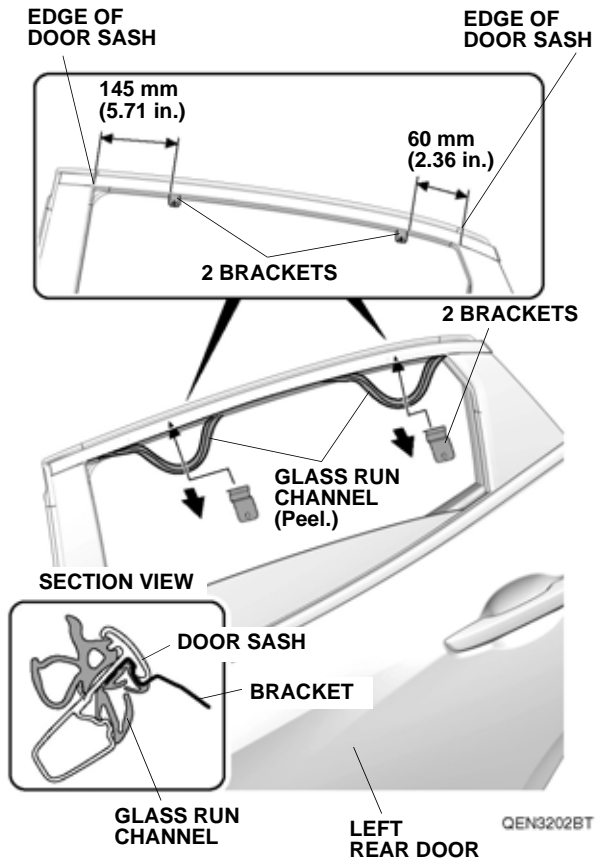

12. Peel the glass run channel as shown.
13. Install two brackets between the door sash and the glass run channel as shown. Seat the glass run channel properly around the brackets.

14. Using an alcohol swab, thoroughly clean the area where the left rear door visor will attach.



15. Peel back the adhesive backing from each adhesive tape and tape the ends to the front surface of the left rear door visor with masking tape.

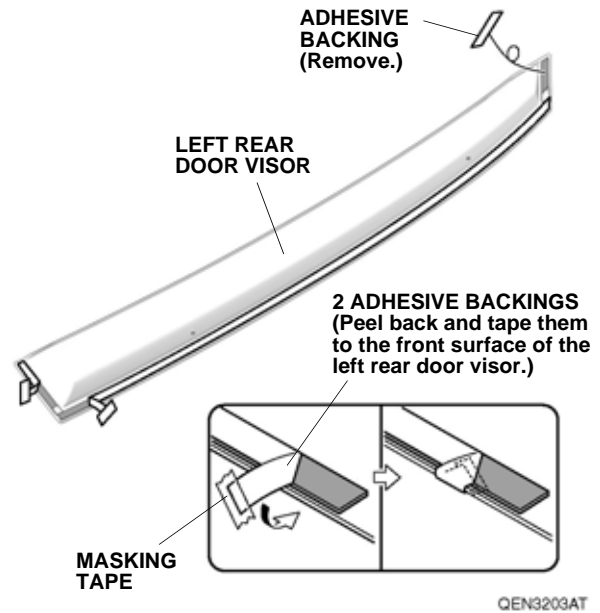

16. Remove the adhesive backing.

17. Line up each hole in the two brackets with the two holes in the left rear door visor.

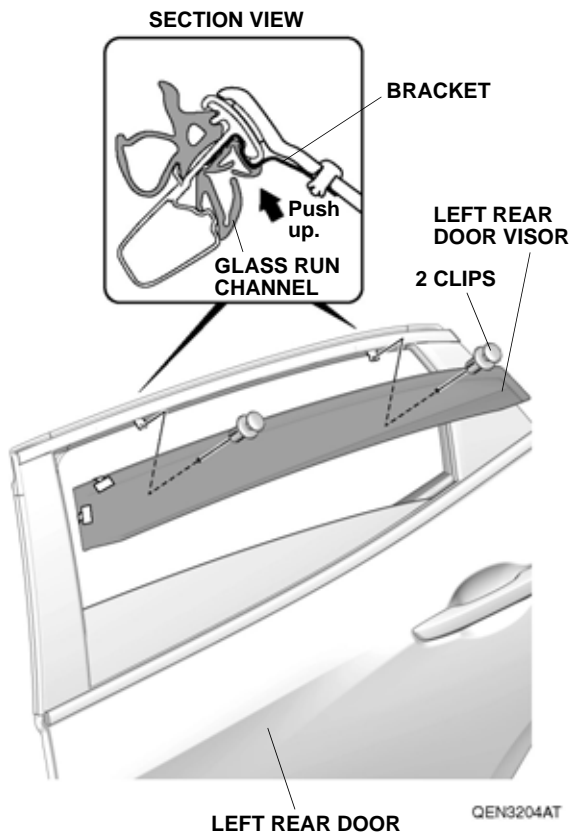

18. Secure the left rear door visor to the two brackets with the two clips. Make sure to push up on the brackets while installing the two clips.
NOTE: Be extremely careful when installing the clips; they cannot be reinstalled after installation.

19. Adjust the position of the left rear door visor as shown.

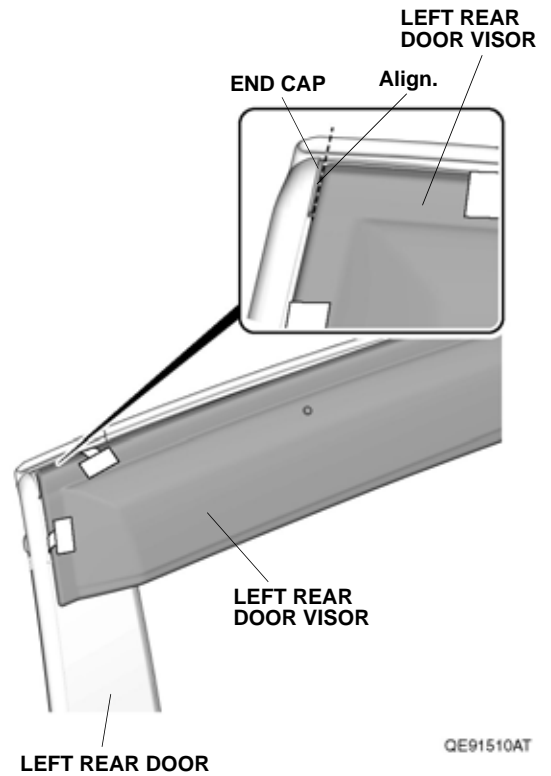

20. While applying light pressure against the left rear door visor, carefully remove the taped adhesive backings in the order shown. Make sure to push up on the brackets while removing the adhesive backings.

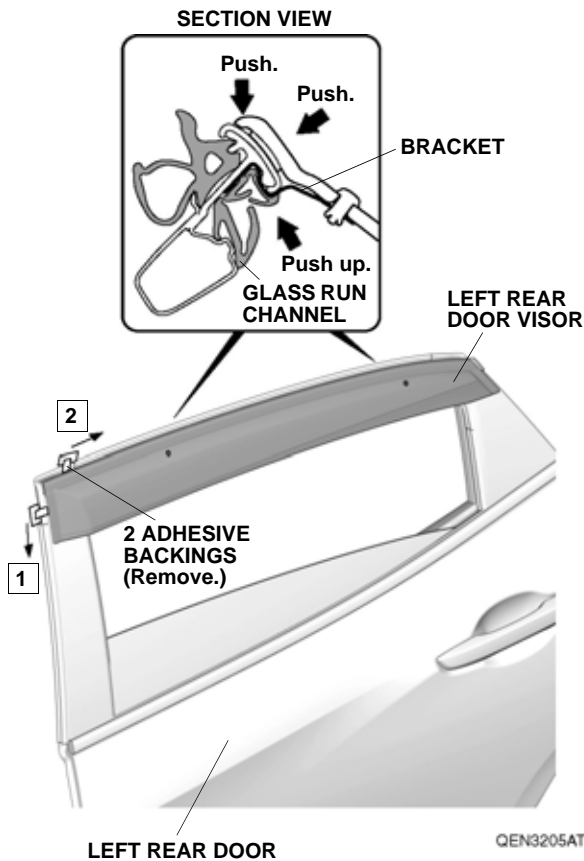

21. Using a soft towel, press and hold the left rear door visor against the door sash for 30 seconds.
22. Repeat steps 1 through 21 on the right side of the vehicle.

CONFIRMATION AFTER INSTALLATION

Restoration and Learning Operations

1. Start the engine.
2. Using the power window switch, repeat opening and closing the window from half-open to fully closed 10 times to allow the glass run channel to wear in. (The window should not bind.)
3. If necessary refer to the service information to reset the power windows. (If the auto up/down feature does not work after the reset, reset again.)
4. If necessary refer to the service information to carry out "learning" of the power window. (If the auto up/down does not function after the learning, carry out "learning" again.)

NOTE: The operations in the steps 3 and 4 should be done to all power windows having the auto up/down feature to allow for proper functioning of the auto-reverse function after installing the door visors.