



## INSTALLATION INSTRUCTIONS

Accessory  
ALL-SEASON FLOOR MATS  
P/N 08P17-TBA-100

Application  
2020 CIVIC  
4- AND 5-DOOR

Publications No.  
**VERSION 1**  
Issue Date  
**AUG 2019**

### PARTS LIST

Driver's all-season floor mat



Passenger's all-season floor mat



Left rear all-season floor mat



Right rear all-season floor mat



### Illustration of the All-season Floor Mats in the Vehicle

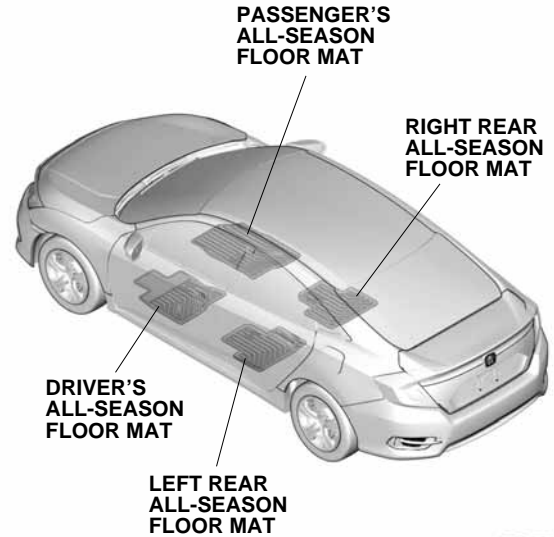

QE30501AU

### INSTALLATION

#### NOTE:

- Before installing the mats, identify their installation positions.
- Connect the mat to the anchors to prevent the mat from sliding forward and possibly interfering with the pedals.
- If you remove a mat, make sure you re-anchor it when you put it back in the vehicle.
- If you replace a mat, use a factory mat designed to be used with anchors.
- If you use a non-factory mat in the driver's footwell, make sure it fits properly and that it can be used with the anchors.
- Do not put an additional mat on top of the anchored mat. An additional mat may slide forward and possibly interfere with the pedals.

## Installing the All-season Floor Mats

1. Remove the floor mats as described in the vehicle Owner's Manual.

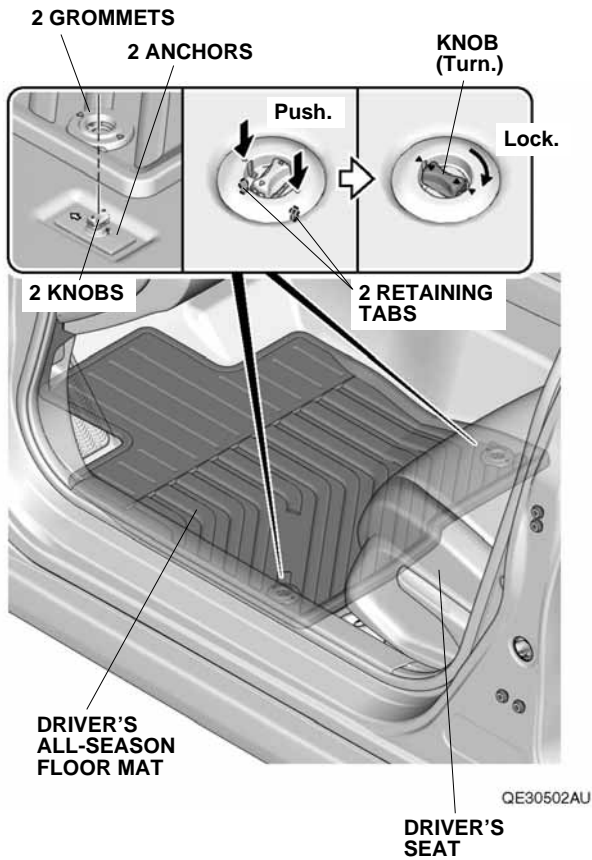

2. Place the grommets in the driver's all-season floor mat over the anchors. Push the grommets into the anchors to secure the retaining tabs, then turn the knobs 90° to secure the all-season floor mat.

3. Place the passenger's all-season floor mat as shown.

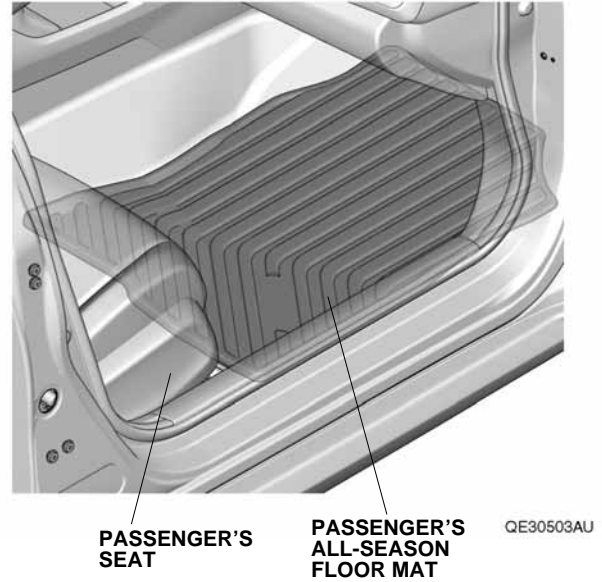

4. Place the left rear all-season floor mat as shown.

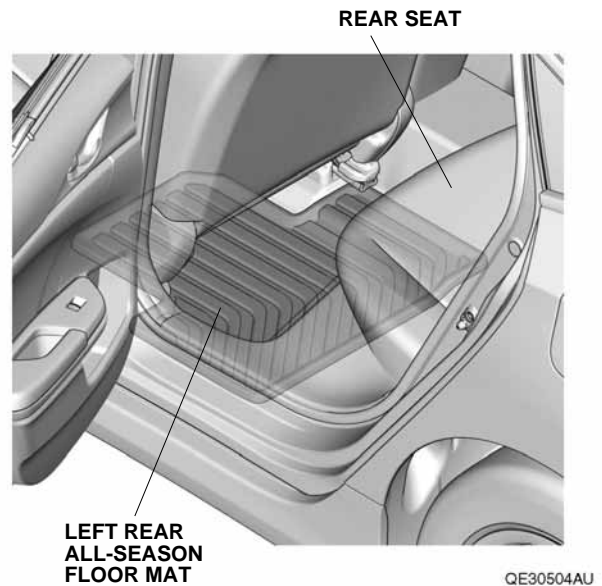

5. Repeat step 4 to install the right rear all-season floor mat on the right side of the vehicle.