



INSTALLATION INSTRUCTIONS

Accessory
BODY SIDE MOLDINGS
 P/N 08P05-TBA-100

Application
2019 CIVIC
4-DOOR

Publications No.
VERSION 1

Issue Date
SEP 2018

PARTS LIST

Left front side molding



Right front side molding



Left rear side molding



Right rear side molding



Template



4 Alcohol swabs



TOOLS AND SUPPLIES REQUIRED

Masking tape

The following tool is available through the Honda Tool and Equipment Program. On the iN, click on Service > Service Bay > Tool and Equipment Program, then enter the number under "Search." Or, call 888-424-6857.

- Rubber Roller (T/N MHLE54D)

INSTALLATION

Customer Information: The information in this installation instruction is intended for use only by skilled technicians who have the proper tools, equipment, and training to correctly and safely add equipment to your vehicle. These procedures should not be attempted by "do-it-yourselfers."

NOTE:

- If you are also installing door edge guards (sold separately), install them before you install the side moldings.
- If you are also installing door edge films (sold separately), install them before you install the side moldings.
- These instructions show the left side moldings being installed. The same procedure applies to installing the right side moldings.
- Be careful not to damage the body paint finish.
- This side moldings kit should be installed only if the ambient air temperature is 15°C (60°F) or above.
- To allow the adhesive to cure, do not wash the vehicle for 24 hours. Make sure your customer is aware of this.

1. Fold the four tabs in the template as shown.

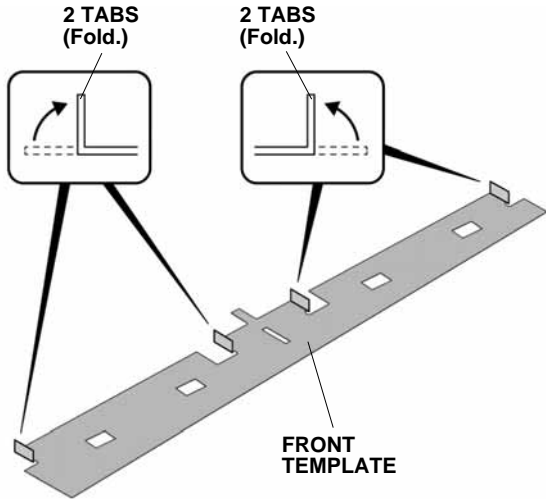

QE31602CH

2. Line up the bottom of the template with the character line of the left front and rear doors, and line up the center hole of the template with the edge of the left front door. Then, attach the template to the left front and rear doors with masking tape as shown.

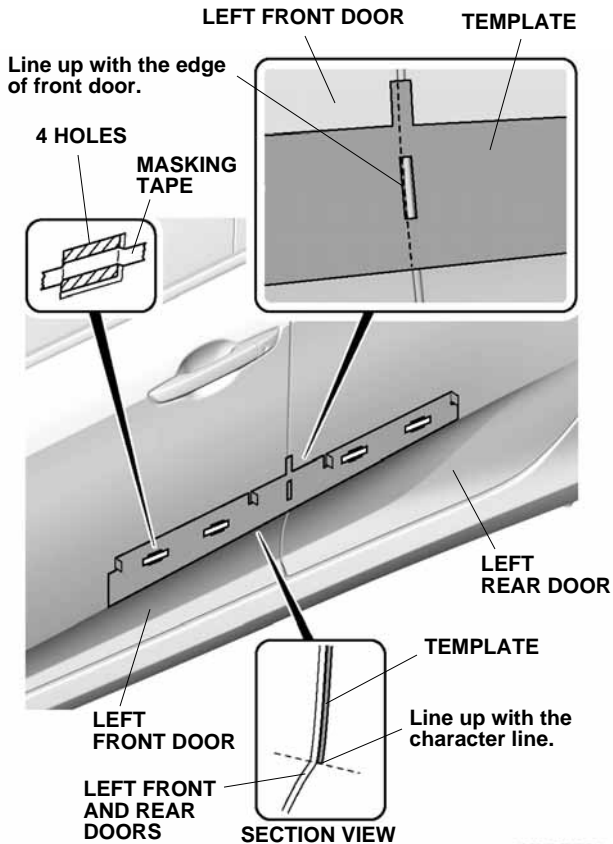

QE31603DH

3. Using an alcohol swab, thoroughly clean the left front door where the left front side molding will attach.

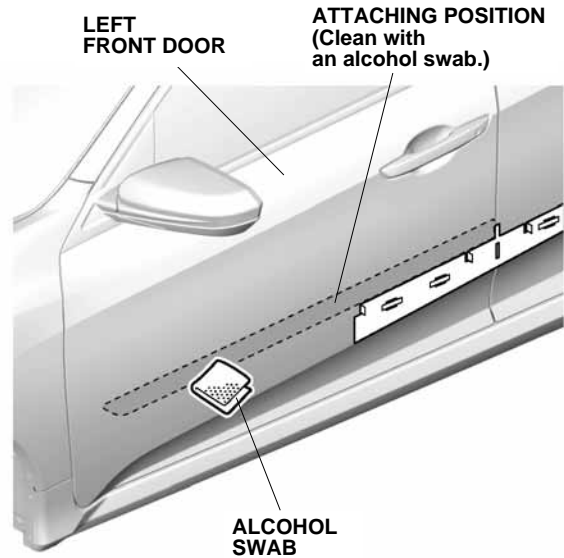

QE31606BH

4. Using an alcohol swab, thoroughly clean the left rear door where the left rear side molding will attach.

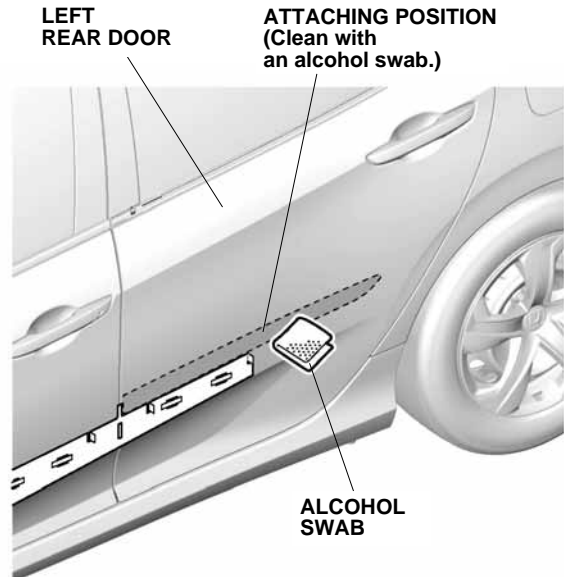

QE31607BH

5. Peel back the adhesive backings and tape them to the front surface of the left front side molding with masking tape. Remove the other adhesive backings.

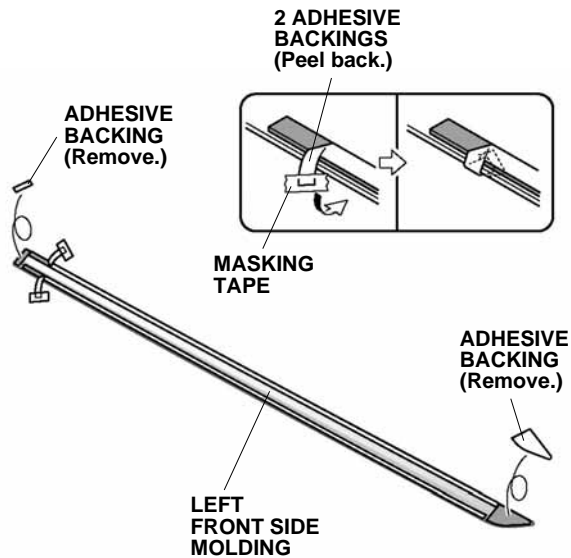

QE31608AH

6. Line up the left front side molding with the template and install the left front side molding on the left front door.

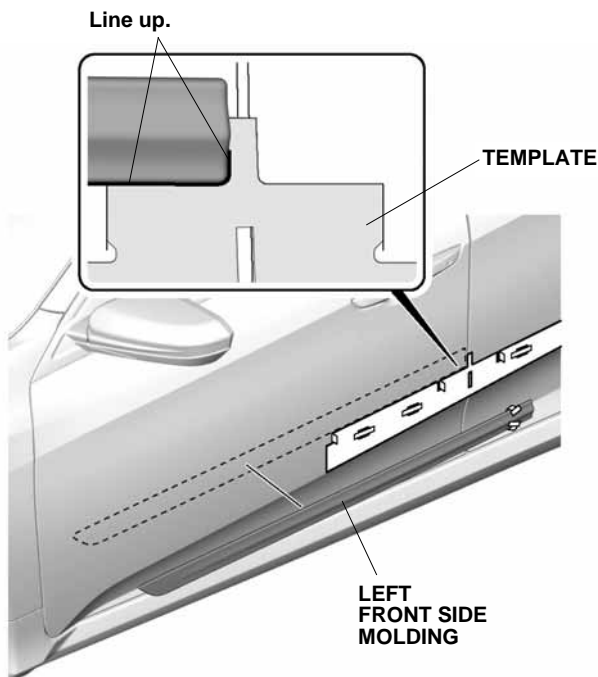

QE31609CH

7. While applying light pressure against the left front side molding, carefully remove the taped adhesive backings.

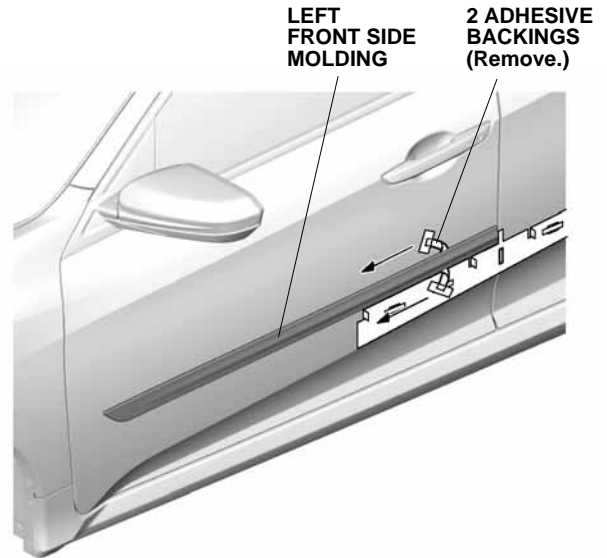

QE31610BH

8. Using a rubber roller, apply firm pressure while rolling, especially at the ends, to set the adhesive.

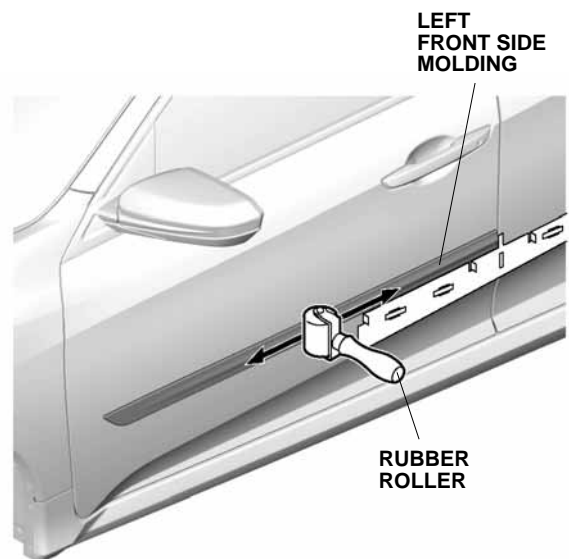

QE31611BH

9. Peel back the adhesive backings and tape them to the front surface of the left rear side molding with masking tape. Remove the other adhesive backings.

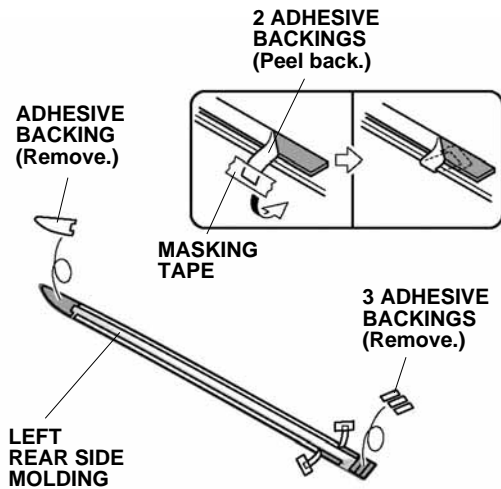

QE31612AH

10. Line up the left rear side molding with the template and install the left rear side molding on the left rear door.

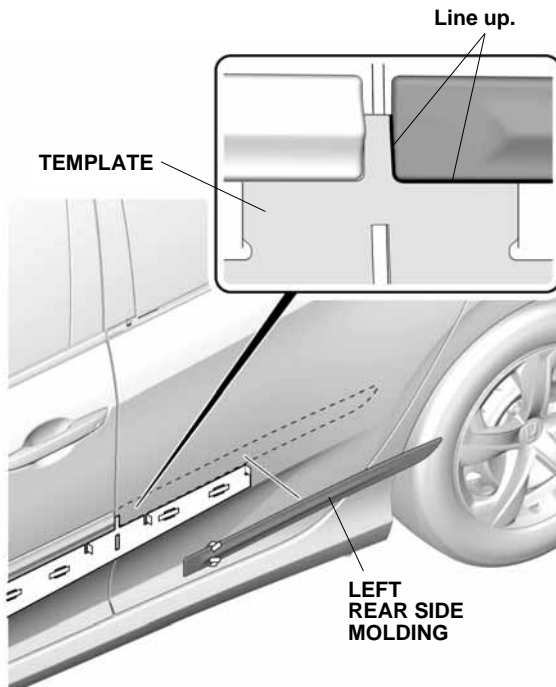

QE31613CH

11. While applying light pressure against the left rear side molding, carefully remove the taped adhesive backings.

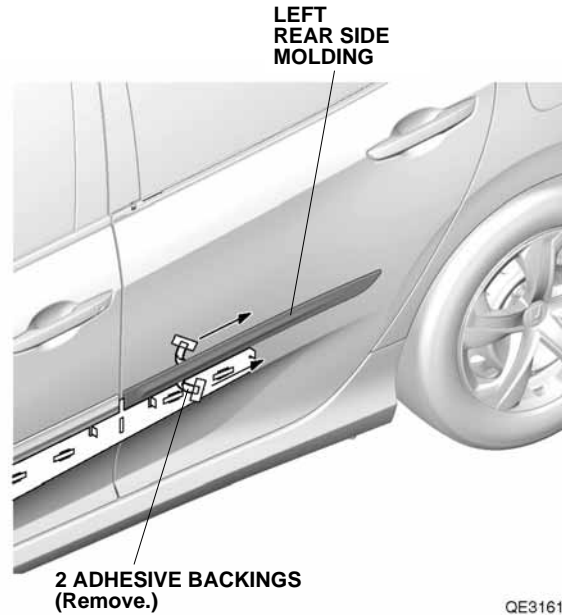

QE31614BH

12. Using a rubber roller, apply firm pressure while rolling, especially at the ends, to set the adhesive.

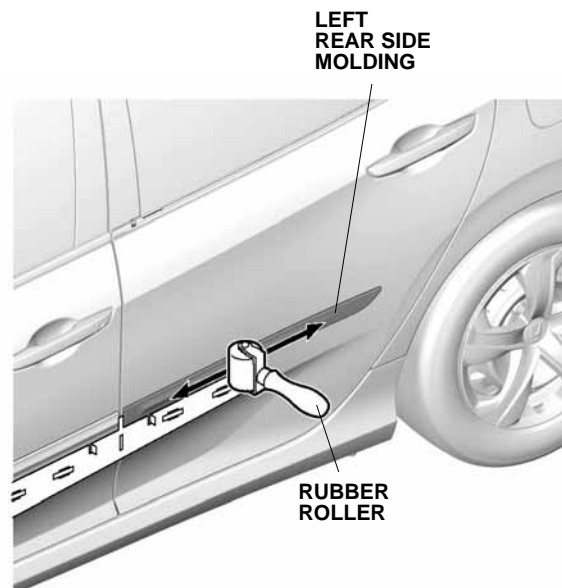

QE31615BH

13. Remove the template.
14. Turn the template over and repeat steps 1 through 13 to install the right side moldings.