



## INSTALLATION INSTRUCTIONS

Accessory  
**19" ALUMINUM WHEEL**  
 P/N 08W19-TEA-100

Application  
**2019 CIVIC**

Publications No.  
**VERSION 1**  
 Issue Date  
**SEP 2018**

### PARTS LIST

Aluminum wheel  
 (The illustration may differ from the actual wheel.)



Wheel center cap  
 (The illustration may differ from the actual center cap.)



Valve



TPMS information  
 (Give this information to your customer.)  
 (May not be used)



Tire pressure information label  
 (EA19A: For 5 door models)  
 (May not be used)



Tire pressure information label  
 (BA19A: For 2 and 4 door models without spare tire)  
 (May not be used)



Tire pressure information label  
 (BA19B: For 2 and 4 door models with spare tire)  
 (May not be used)



Wheel cleaning information  
 (Give this information to your customer.)

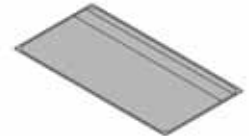

Supplemental Information  
 (Give this information to your customer.)



### TOOLS AND SUPPLIES REQUIRED

- 19 mm Socket
- Torque wrench
- Isopropyl alcohol
- Shop towel
- i-HDS
- DST-i

## SPECIFICATIONS

Rim size		19 x 8J (inset 55)	
Tire size		235/35R19 91Y	
Bolt hole PCD		114.3 (5 holes)	
Tire pressure	5 DOOR	Front	39 psi (270 kPa)
		Rear	39 psi (270 kPa)
	2 DOOR AND 4 DOOR	Front	35 psi (240 kPa)
		Rear	35 psi (240 kPa)

## INSTALLATION

**Customer Information:** The information in this installation instruction is intended for use only by skilled technicians who have the proper tools, equipment, and training to correctly and safely add equipment to your vehicle. These procedures should not be attempted by “do-it-yourselfers.”

### NOTE:

- The illustrations of the aluminum wheels are shown for reference purposes only.
- Install the correct size tire.
- Use a tire changer to install and remove the tires as described in the operation manual furnished with the tire changer. Do not use a tire lever to install and remove the tires as it may cause damage to the tire and aluminum wheel.
- The wheel nut torque is 80 lb-ft (108 N·m).

1. Open the driver’s door. Using isopropyl alcohol on a shop towel, thoroughly clean the area where the tire pressure information label will attach. Remove the adhesive backing from the tire pressure information label, and attach it over the standard tire pressure information label as shown.

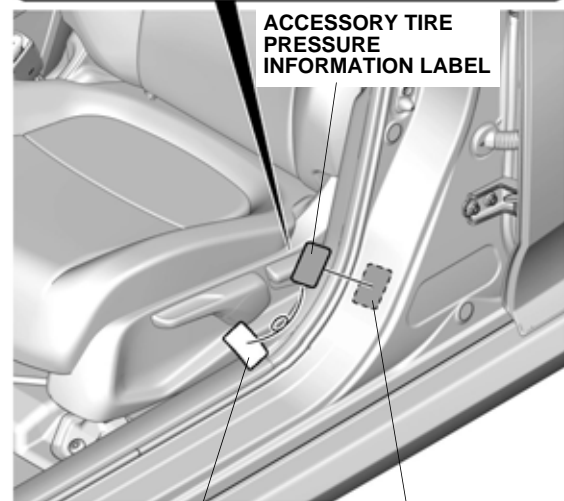
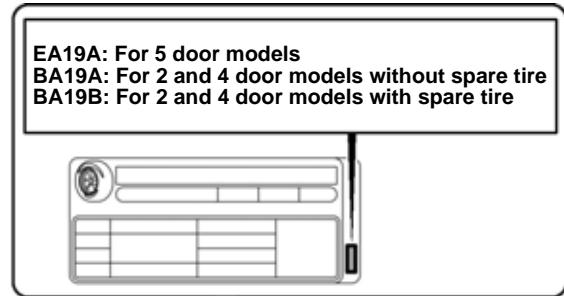

ADHESIVE BACKING  
(Remove.)

STANDARD TIRE PRESSURE  
INFORMATION LABEL  
(Clean with isopropyl  
alcohol.)

2. Attach the “Supplemental Information” page included in this kit into the owner’s guide as described on the “Important Information to Dealer” page.

## Inch-up Tire Pressure Programming (2 and 4 Door models)

- Connect the i-HDS/DST-i to the data link connector, then turn the ignition switch on.

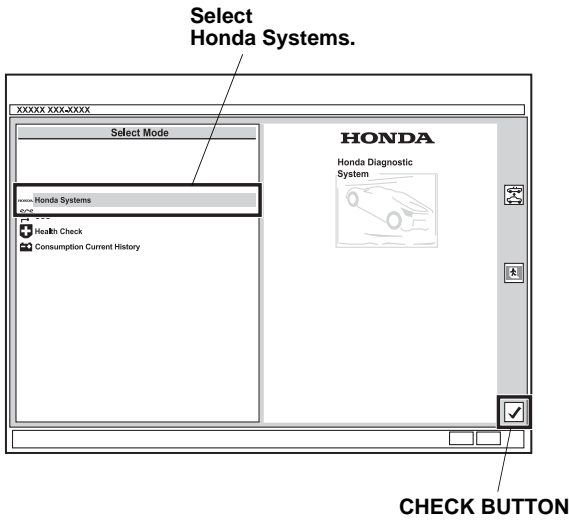

- Start the Honda Diagnostic System.
- Select the Honda Systems and click the check button.
- Select the ABS/TCS/VSA and click the check button.

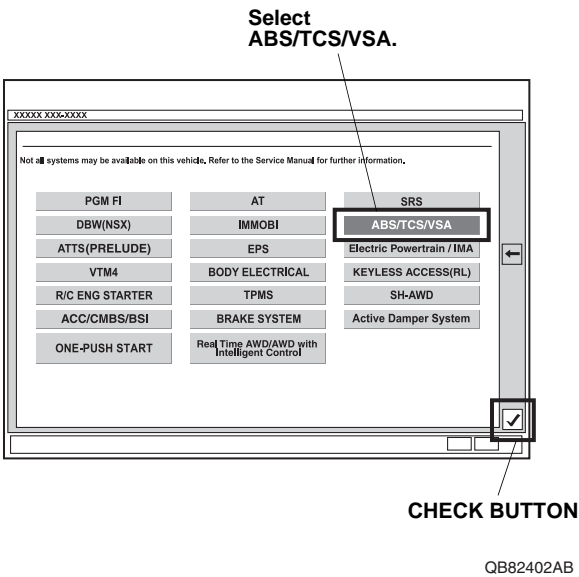

- Select the TPMS (VSA) threshold and click the check button.

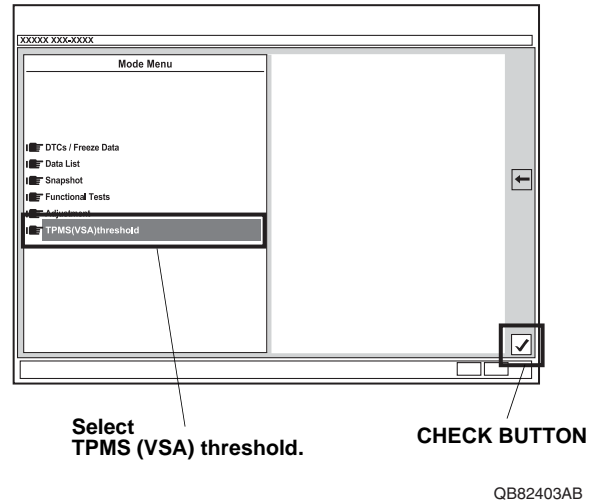

- Select the YES.

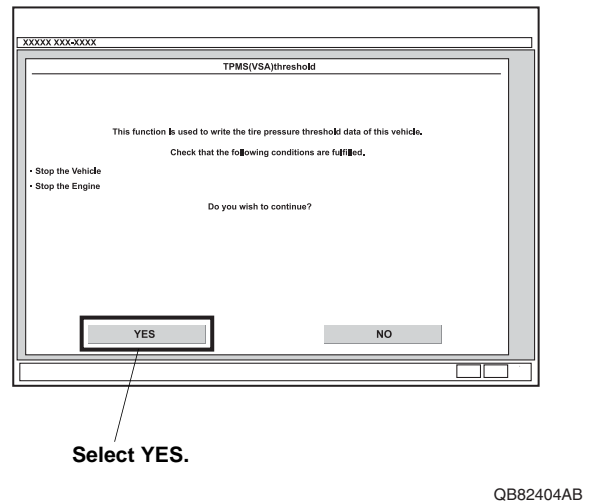

9. Select the 19 inch and Summer, and click the check button.

Select 19 inch.

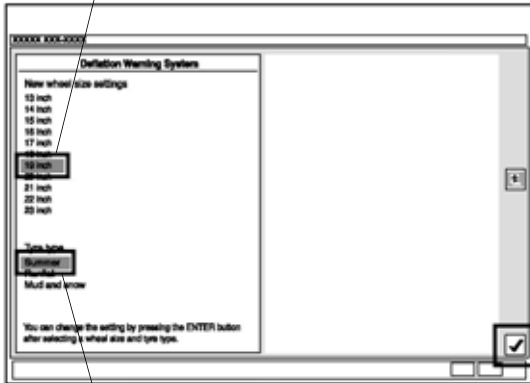

Select Summer.

QG50303AT

10. Select the YES.

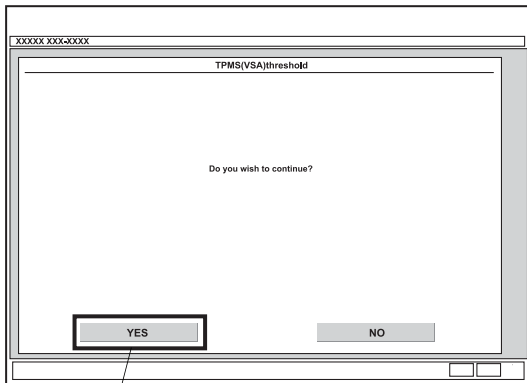

Select YES.

QB82406AB

11. Click the check button.

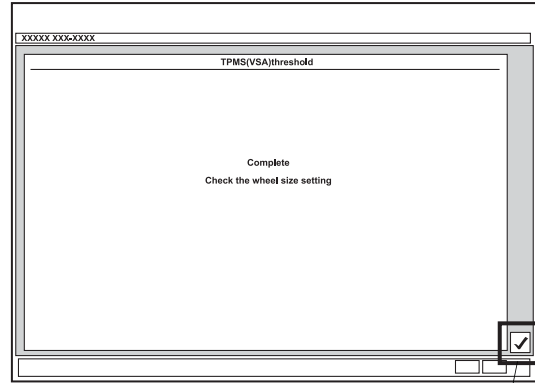

CHECK BUTTON

QB82407AB

12. Turn the ignition switch off.

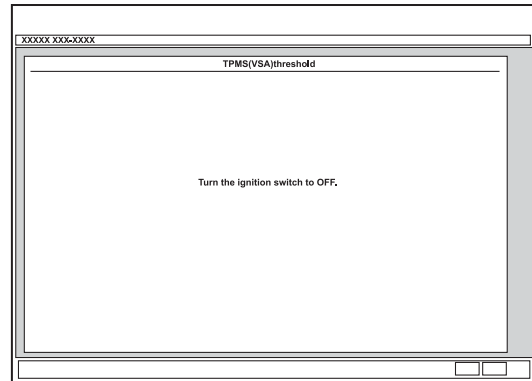

QB82408AB

13. The following message will display: Turn the ignition switch to ON. Then turn the ignition switch on.

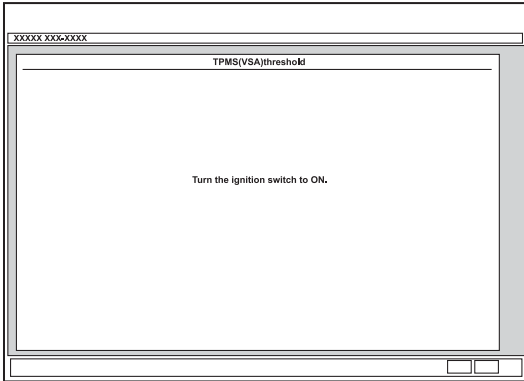

QB82409AB

14. Disconnect the i-HDS/DST-i from the data link connector.
15. Do the TPMS calibration according to the instructions in the service information (TPMS Calibration).
16. After finishing the work, write tire size, tire pressure, i-HDS version number, dealer name, technician's signature, and date in "Service History Page for Honda Accessory Alloy Wheels" page included in this kit.
- Be sure to explain the contents of the "Supplemental Information" when delivering the vehicle to your customer.
  - Be sure to give the TPMS information and wheel cleaning information to your customer.

## Deflation Warning System Threshold Rewriting

- If the 18-inch wheels are to be installed back on the vehicle, you must change the threshold value with the i-HDS; refer to steps 3 through 15.
- For step 9, select 18-inch, and Summer.

NOTE: If 18-inch is displayed on the current wheel size settings, go to step 14.

- After finishing the work, write tire size, tire pressure, i-HDS version number, dealer name, technician's signature, and date in "Service History Page for Honda Accessory Alloy Wheels" page.