



INSTALLATION INSTRUCTIONS

Accessory
WING SPOILER

Application
2013 CIVIC
4-DOOR

Publications No.
All 13084
Issue Date
NOV 2012

PARTS LIST

Wing spoiler



Right trunk spring (marked red)



Left trunk spring (marked yellow)



Template

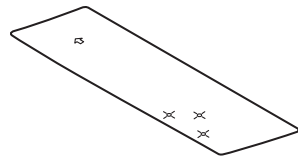

Urethane tape

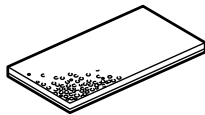

4 Cap nuts



Subharness



7 Wire ties

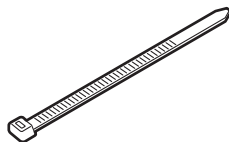

2 EPT sealers

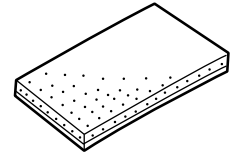

Alcohol swab

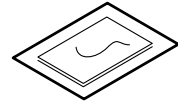

TOOLS AND SUPPLIES REQUIRED

Phillips screwdriver

Drill

Eye protection (face shield, safety goggles, etc.)

Center punch

File

Touch-up paint

Felt-tip pen

Diagonal cutters

Shop towel

Isopropyl alcohol

Ratchet

10 mm Socket

Torque wrench

Tape

Heavy gloves

High-quality paste wax

10 mm Open end wrench

Masking tape

The following tools are available through the Honda Tool and Equipment Program. On the iN, click on: Service > Service Bay > Tool and Equipment Program, then enter the number under "Search". Or, call 888-424-6857.

- Trim Tool Set (T/N SOJATP2014)
- Trunk Spring Tool (T/N 07AAZ-S0KA100)
- Rotabroach Hole Cutting Kit (T/N BLR11201SO)

Illustration of the Wing Spoiler on the Vehicle

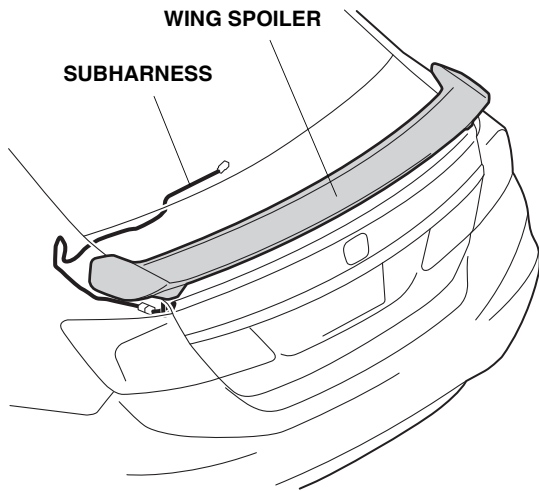

QB51501AJ

INSTALLATION

Customer Information: The information in this installation instruction is intended for use only by skilled technicians who have the proper tools, equipment, and training to correctly and safely add equipment to your vehicle. These procedures should not be attempted by "do-it-yourselfers."

NOTE:

- Be careful not to damage the paint finish.
 - This wing spoiler kit should be installed only if the ambient air temperature is 15°C (60°F) or above.
 - Clean and wax the areas to be covered with a high-quality paste wax.
 - To allow the adhesive to cure, do not wash the vehicle for 24 hours. Please advise the customer.
1. Disconnect the negative cable from the battery.

2. Open the trunk lid. If equipped, remove the trunk lid trim panel (11 clips).

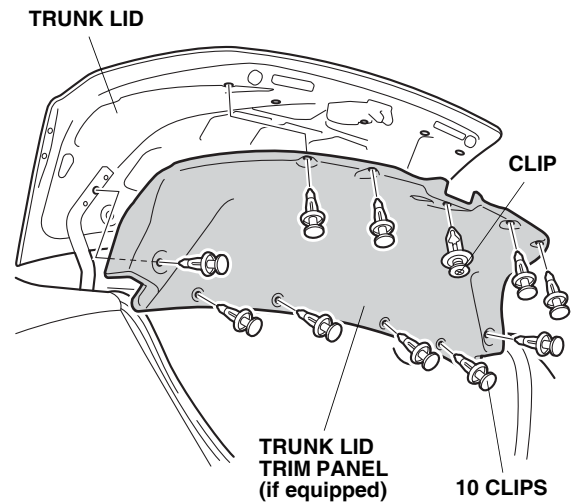

Q072802BJ

Installing the Wing Spoiler

3. Close the trunk lid. To prevent the metal shavings from falling onto the trunk floor, attach strips of tape to the trunk lid as shown.

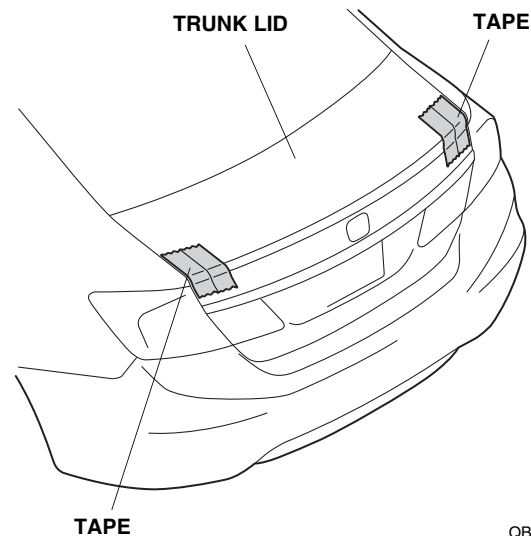

QB51101AJ

4. Place the template on the left side of the trunk lid, and align the template with the edge of the trunk lid as shown. Tape the template to the trunk lid with strips of masking tape.

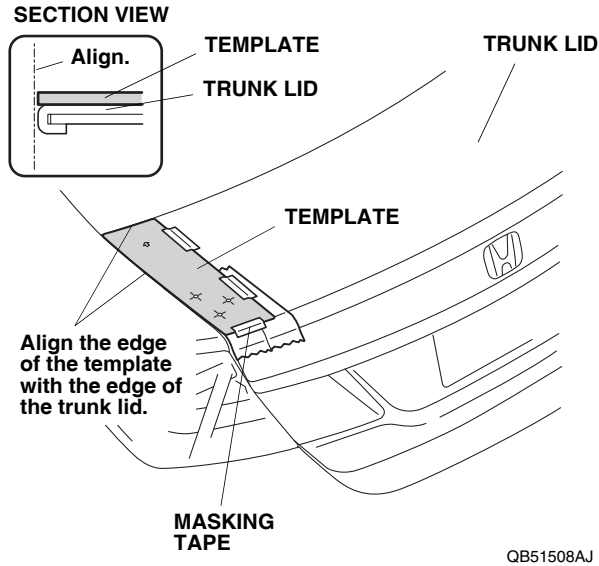

5. Using a felt-tip pen, mark the trunk lid through the template at the three locations shown on the template.

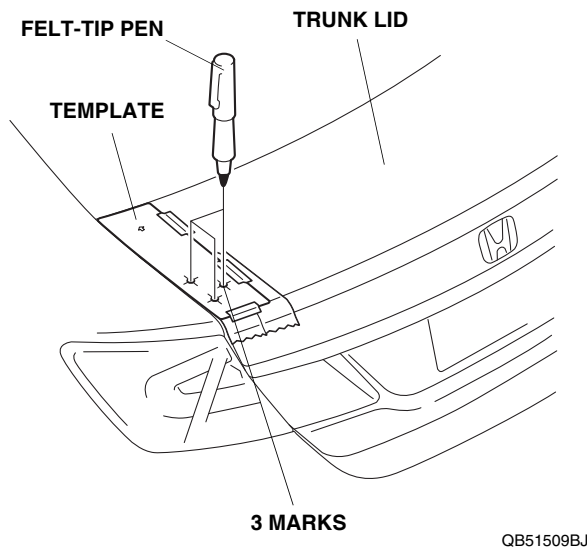

6. Remove the template.

7. Turn the template over. Place the template on the right side of the trunk lid, and align the template with the edge of the trunk lid as shown. Tape the template to the trunk lid with strips of masking tape.

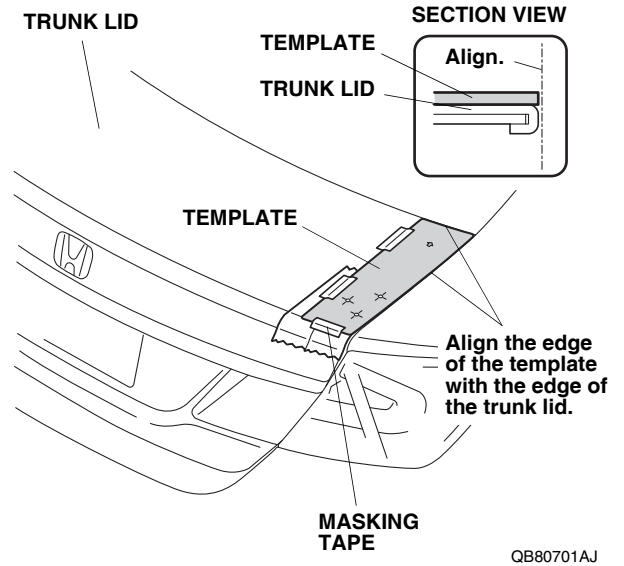

8. Using a felt-tip pen, mark the trunk lid through the two outboard in the template. Do not mark the inboard hole.

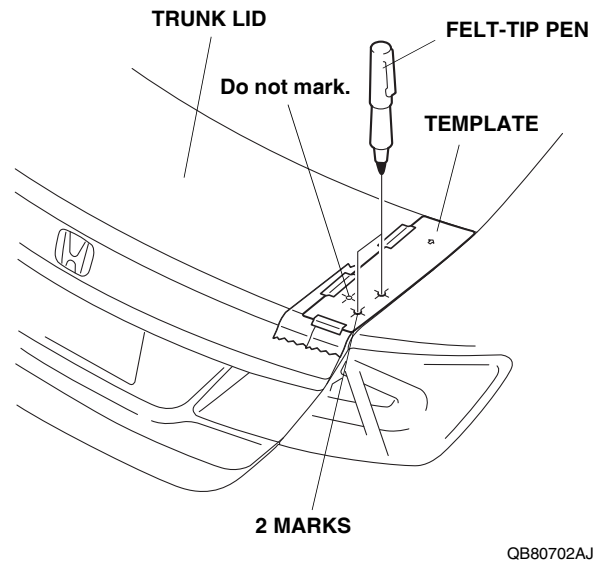

9. Remove the template.

10. Center-punch the five marks you made on the trunk lid. If using an automatic center punch, set it to the minimum setting.

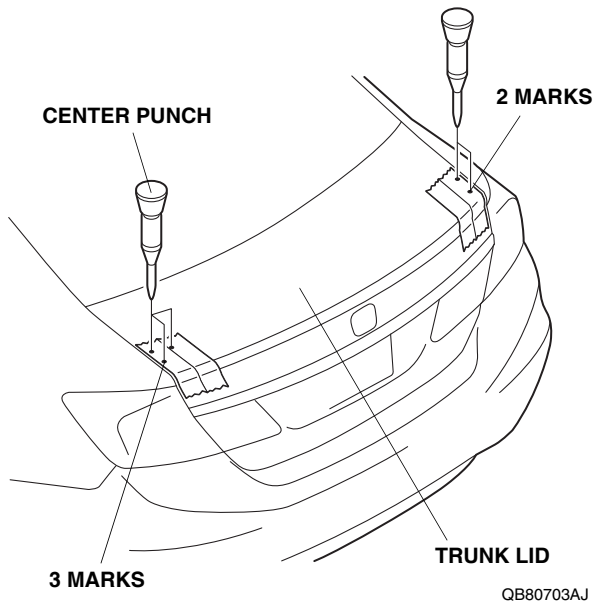

11. While wearing eye protection, drill four outboard 8 mm holes at the center-punched marks with an 8 mm hole cutter. Drill perpendicular to the trunk lid.

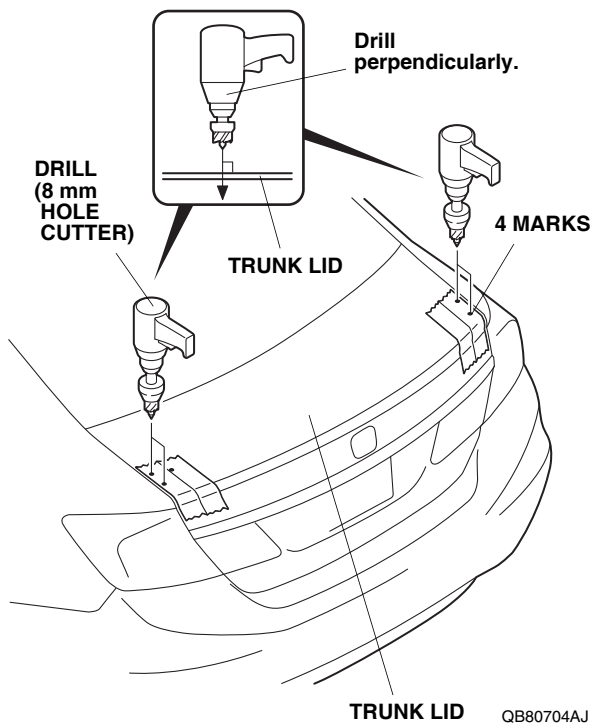

12. While wearing eye protection, drill a 10 mm hole at the remaining center-punched mark with a 10 mm hole cutter. Drill perpendicular to the trunk lid.

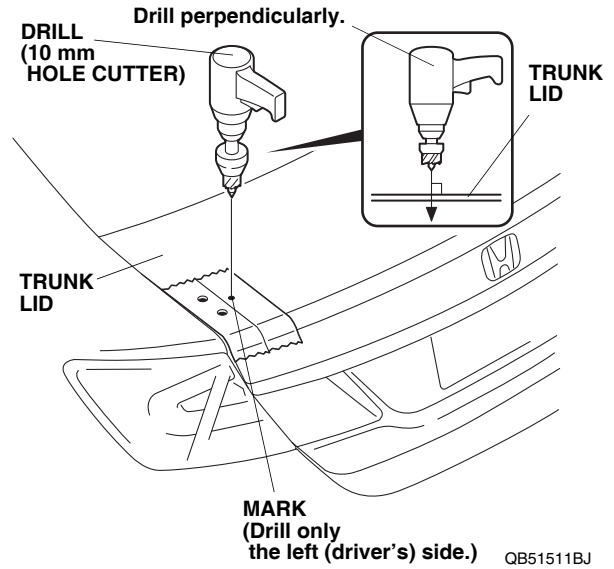

13. Remove the tape installed in step 3. Remove all burrs and metal shavings with a file, and apply touch-up paint to the edges of the holes.
14. Fit the four studs on the wing spoiler into the four 8 mm holes to check the hole positions. If the holes/studs do not align, enlarge the holes with a file and apply touch-up paint. After the paint has dried, check the alignment again.

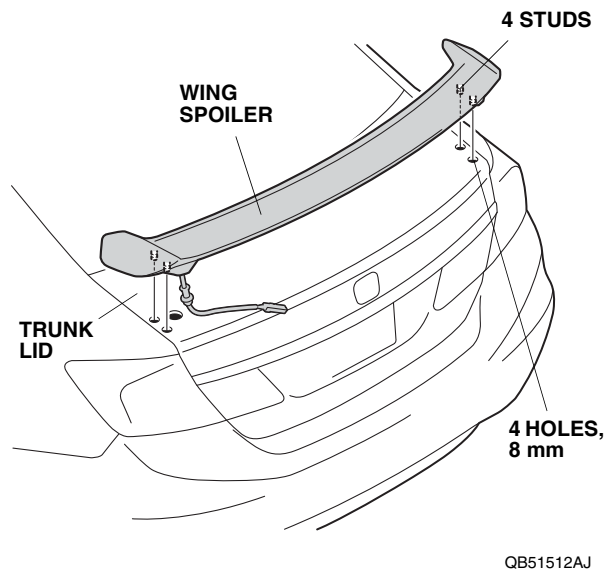

15. Remove the wing spoiler.

16. Using the alcohol swab, thoroughly clean the trunk lid where the wing spoiler will attach.

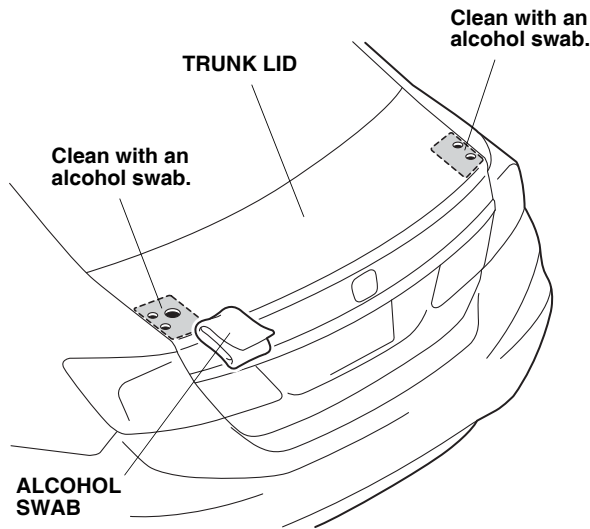

QB51513AJ

17. Route the wing spoiler harness down through the 10 mm hole you just drilled. Seat the grommet in the 10 mm hole.
- Route the wing spoiler harness 2-pin connector as shown.
 - Install the wing spoiler harness by holding the grommet.
 - Make sure to check that the grommet is secured properly.

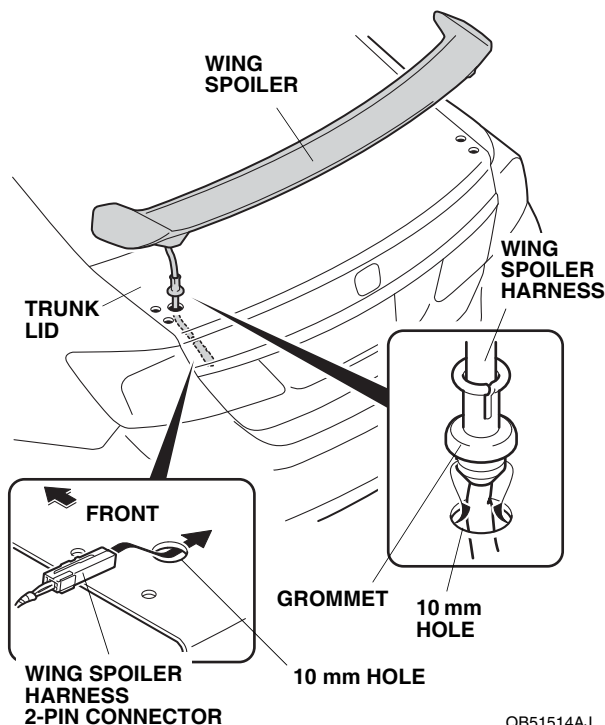

QB51514AJ

18. Remove two adhesive backings from the wing spoiler.

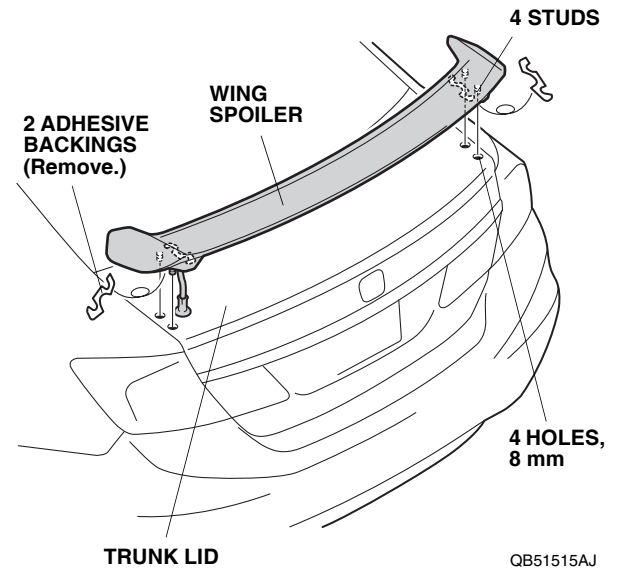

QB51515AJ

19. Position the wing spoiler on the trunk lid by inserting four studs into the 8 mm holes in the trunk lid.
20. Hold the wing spoiler firmly against the trunk lid over the adhesive tapes with the palm of your hand for 30 seconds.
21. Open the trunk lid. Install four cap nuts on the wing spoiler studs, two on each side. Torque the cap nuts to 9.0 N·m (6.5 lbf·ft).

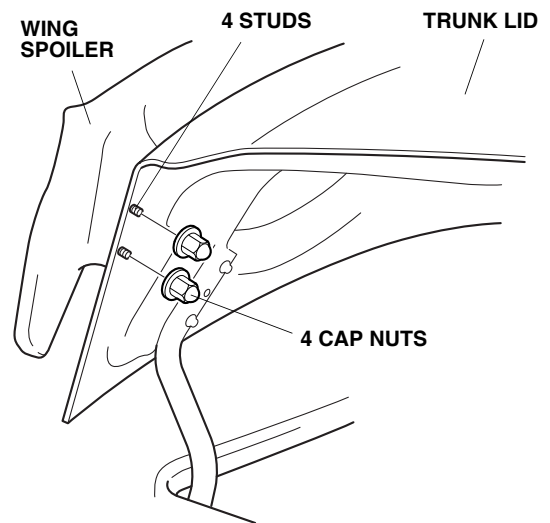

Q072813AJ

Installing the Trunk Springs

22. Push the tabs, and pull down the left and right seat-back release levers to release the hooks. Move the left and right seat-back release levers out of your way.

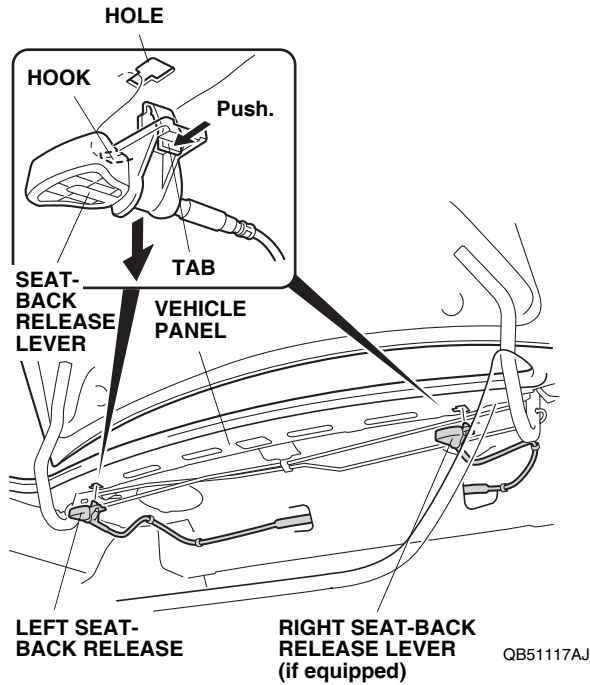

23. Remove the center clip from the left and right trunk springs.

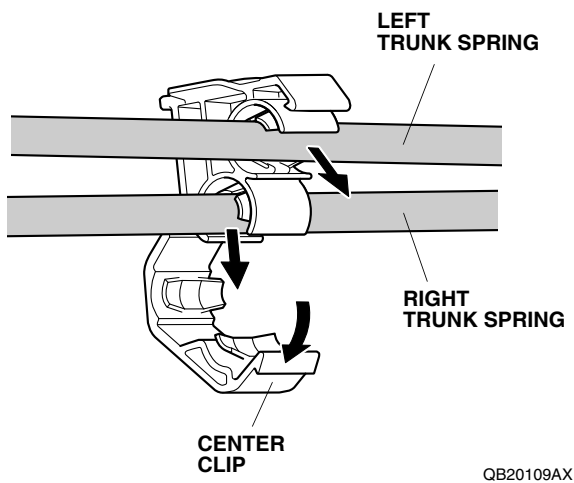

24. Put on heavy gloves to protect your hands. With an assistant holding the trunk lid open, remove both trunk springs with the trunk spring tool. Pull the trunk spring tool slowly and carefully toward you. First remove the right trunk spring, then remove the left trunk spring.

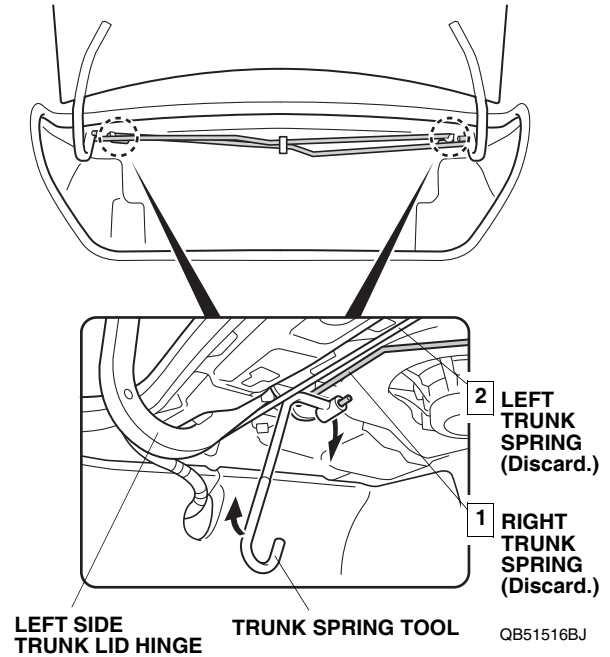

25. Install the new left and right trunk springs in the reverse order of removal:
- Install the yellow marked trunk spring in the slot in the left side (driver's side) trunk lid hinge and to the right (passenger's side) hinge bracket; install the red marked trunk spring in the slot in the right side (passenger's side) trunk lid hinge and to the left (driver's side) hinge bracket.
 - Rotate the trunk spring tool as you pull it towards you.
 - Set the trunk springs in the first notch of the hinge brackets if the vehicle is not equipped with a trunk lid trim panel; set the trunk springs in the second notch of the hinge brackets if the vehicle is equipped with a trunk lid trim panel.

NOTICE: Be careful when installing the trunk springs it could repel with strong force and cause injury.

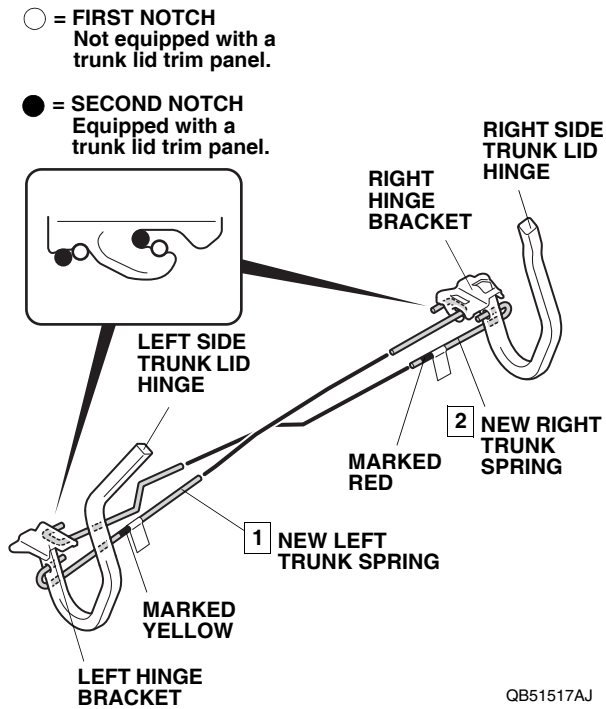

26. Reinstall the center clip to the trunk springs.

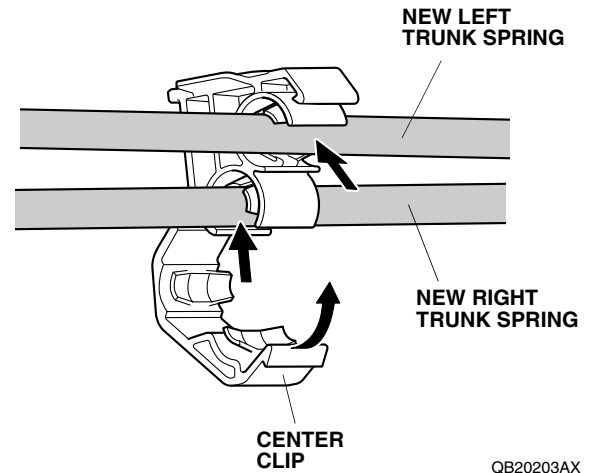

Routing the Subharness

27. Remove two clips from the left side trunk trim.

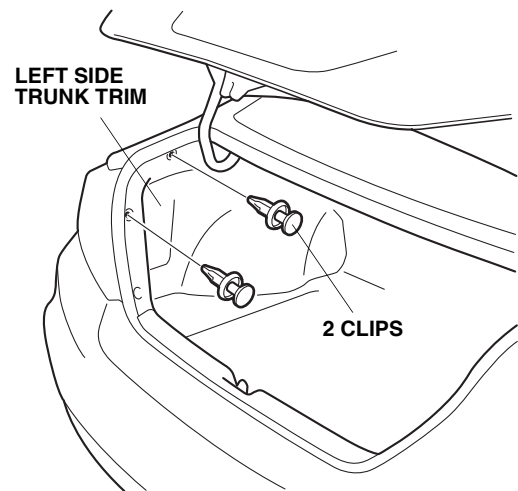

28. Using isopropyl alcohol on a shop towel, thoroughly clean the trunk lid where the urethane tape will attach.

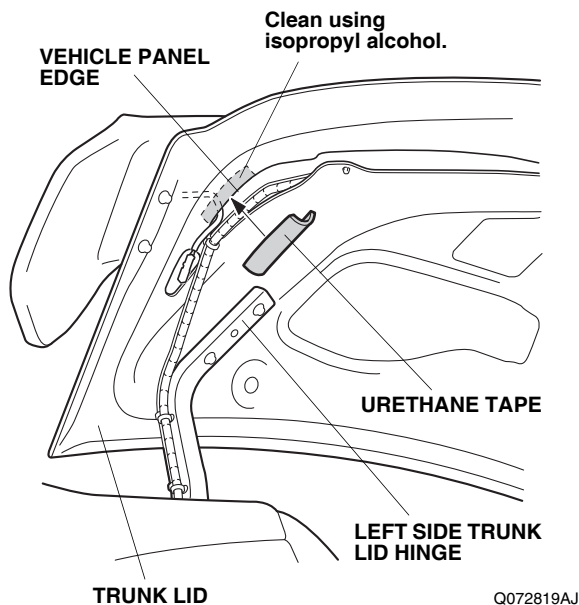

29. Apply the urethane tape to the vehicle panel edge as shown.
30. Secure the wing spoiler harness to the vehicle harness with one wire tie. Do not secure the wire tie to the trunk opener cable.

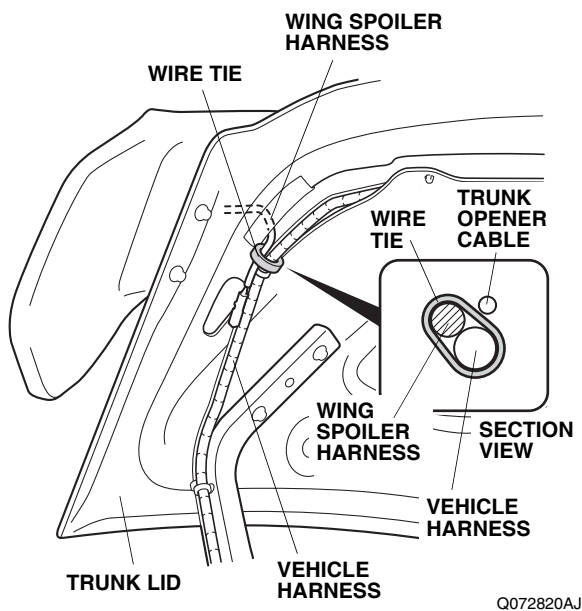

31. Route the subharness through the holes in the vehicle panel as shown.

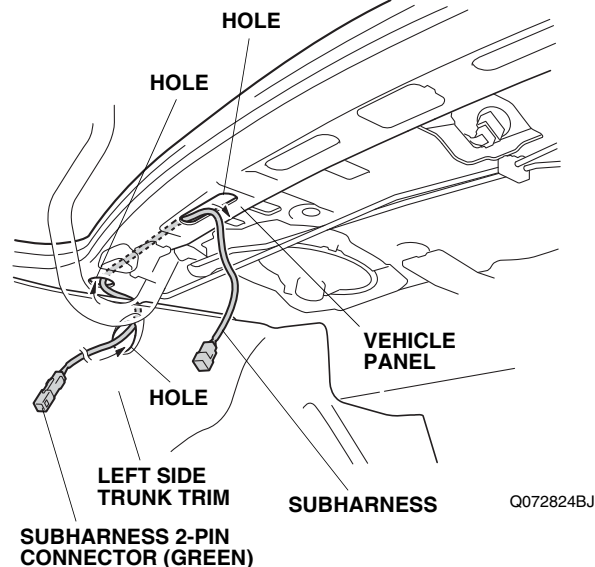

32. Continue to route the subharness through the holes in the vehicle panel as shown.

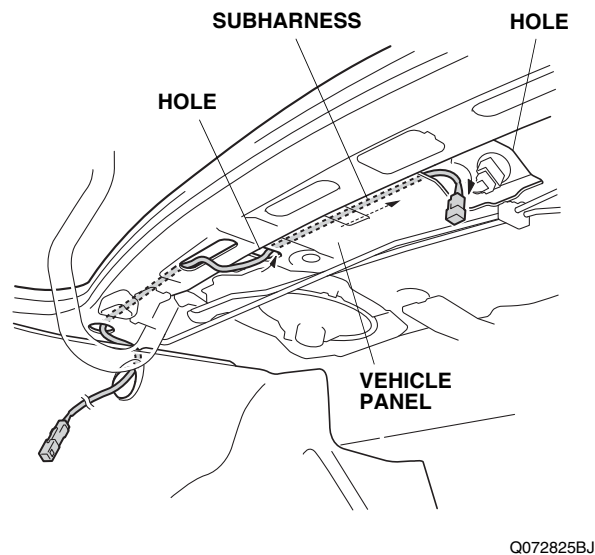

33. Unplug the vehicle 2-pin connector from the high-mount brake light connector.

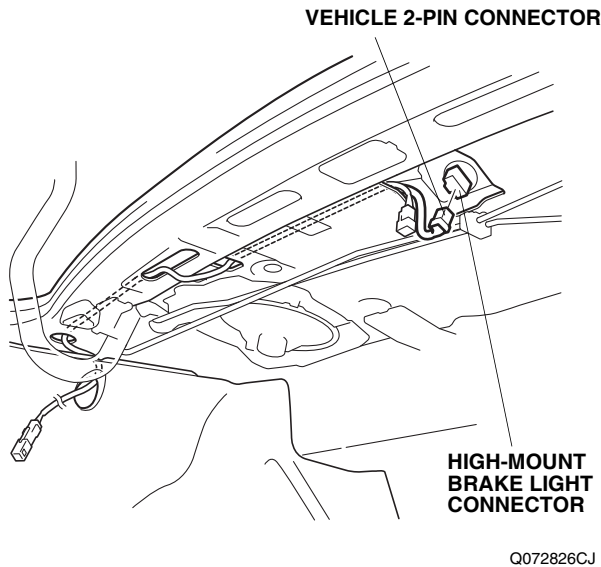

34. Plug the vehicle 2-pin connector into the subharness 2-pin connector. Wrap one EPT sealer around the vehicle 2-pin connector and the subharness 2-pin connector.

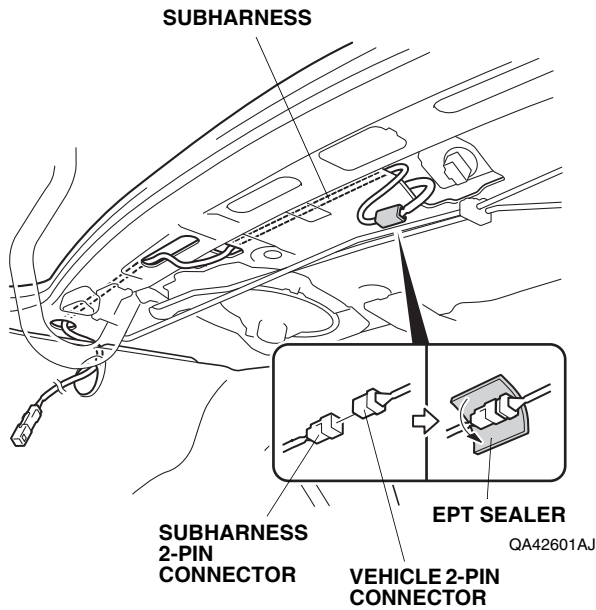

35. Align the green tape on the subharness with the vehicle clip, and secure the subharness to the vehicle harness with one wire tie.

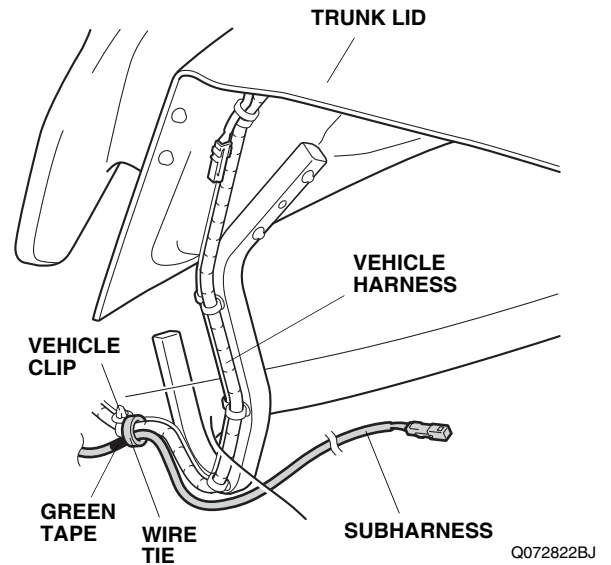

36. Connect two wire ties together and secure the subharness to the vehicle panel with the connected wire tie.

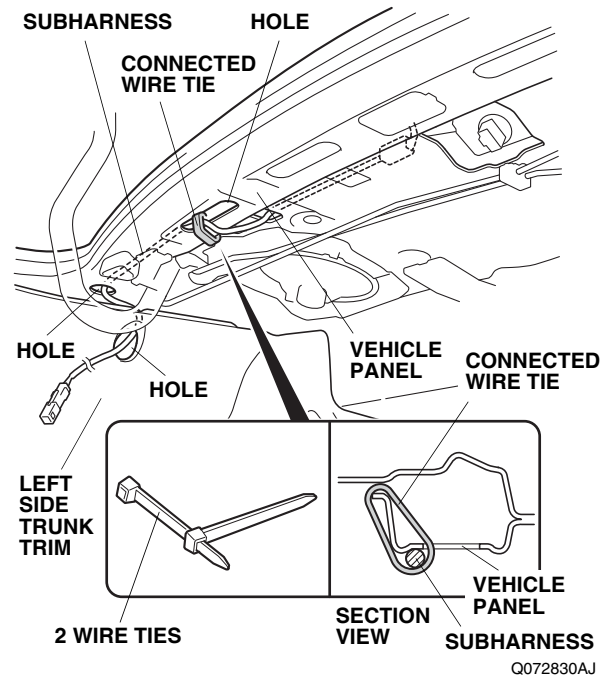

37. Plug the wing spoiler harness 2-pin connector into the subharness 2-pin connector. Wrap one EPT sealer around the wing spoiler harness 2-pin connector and the subharness 2-pin connector.

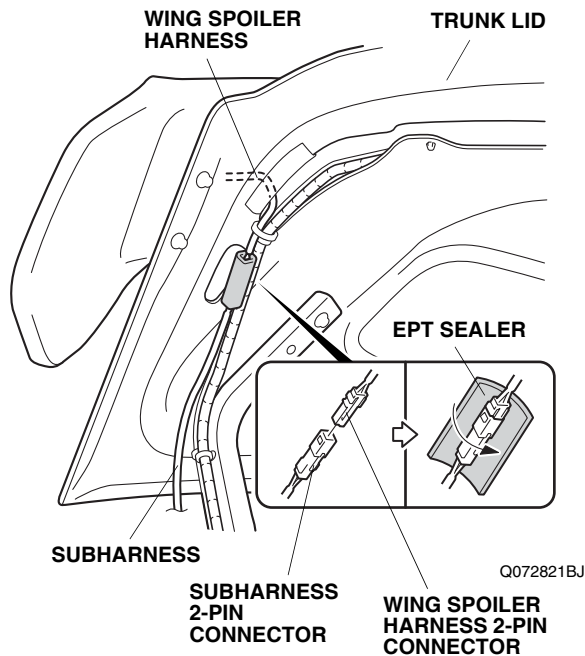

38. Secure the subharness to the vehicle harness with three wire ties in the area shown. Do not secure the wire tie to the trunk opener cable.

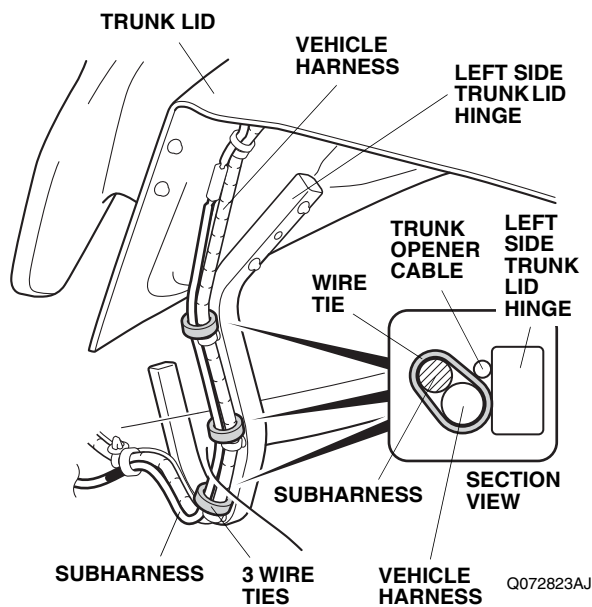

39. Check that all wire harnesses are routed properly and all connectors are plugged in.
40. Reinstall all removed parts.
41. Reconnect the negative cable to the battery, and check operation of all of the lights.
42. Press and hold the radio power button for two seconds to restore radio and navi (if equipped) system functions.
43. Reset the clock on vehicles without navigation.