



INSTALLATION INSTRUCTIONS

Accessory
SIDE UNDER SPOILERS
P/N 08F04-TVA-100

Application
2019 ACCORD

Publications No.
VERSION 1
Issue Date
OCT 2018

PARTS LIST

Left spoiler



Right spoiler



26 Seals

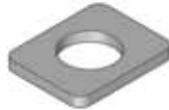

TOOL AND SUPPLIES REQUIRED

Phillips screwdriver

Stubby Phillips screwdriver

Masking tape

The following tools are available through the Honda Tool and Equipment Program. On the iN, click on Service > Service Bay > Tool and Equipment Program, then enter the number under "Search." Or, call 888-424-6857.

- Trim Tool Set (T/N SOJATP2014)
- Plastic Trim Tool (T/N SILTRIMTL10)

Illustration of the Side Under Spoilers on the Vehicle

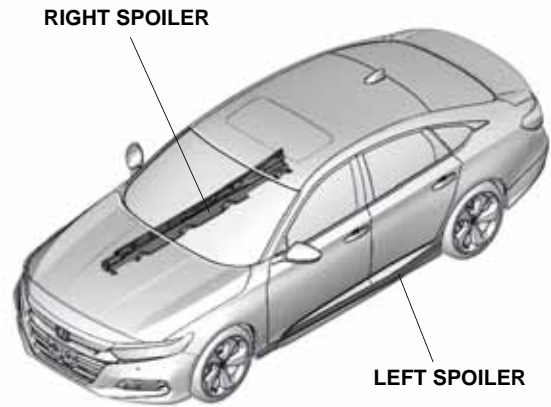

QG20301AN

INSTALLATION

Customer Information: The information in this installation instruction is intended for use only by skilled technicians who have the proper tools, equipment, and training to correctly and safely add equipment to your vehicle. These procedures should not be attempted by "do-it-yourselfers."

NOTE: Be careful not to damage the body paint finish.

Installing the Spoilers

1. Turn the steering wheel fully counterclockwise.

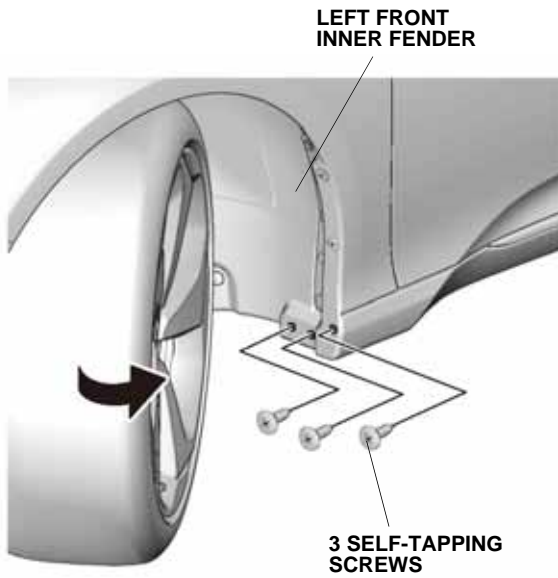

QG20302AN

2. Remove the three self-tapping screws from the left front inner fender.
3. Remove the four clips from the left side sill trim.

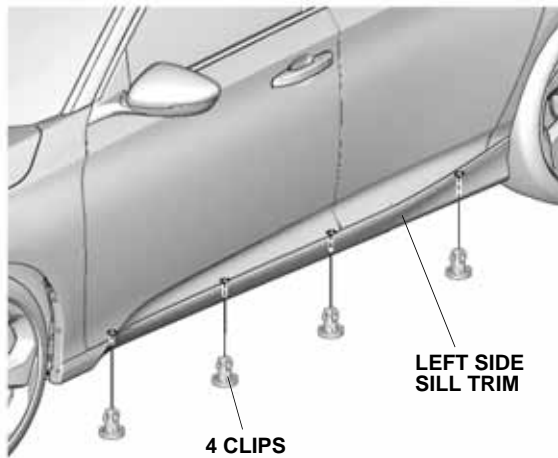

QG20303AN

4. Remove the left side sill trim as shown.

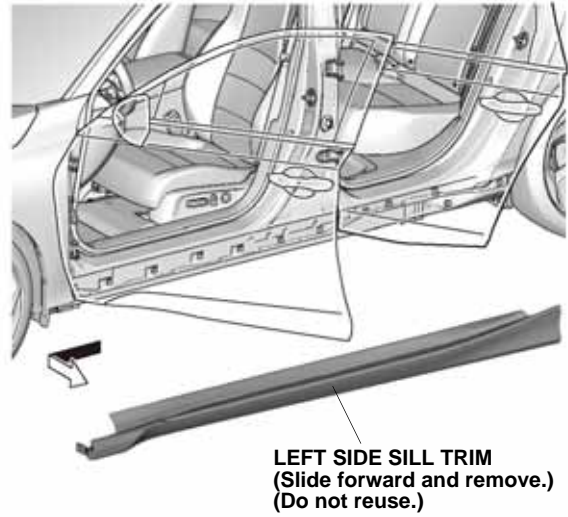

QG20304AN

5. Remove the 13 clips from the vehicle panel.

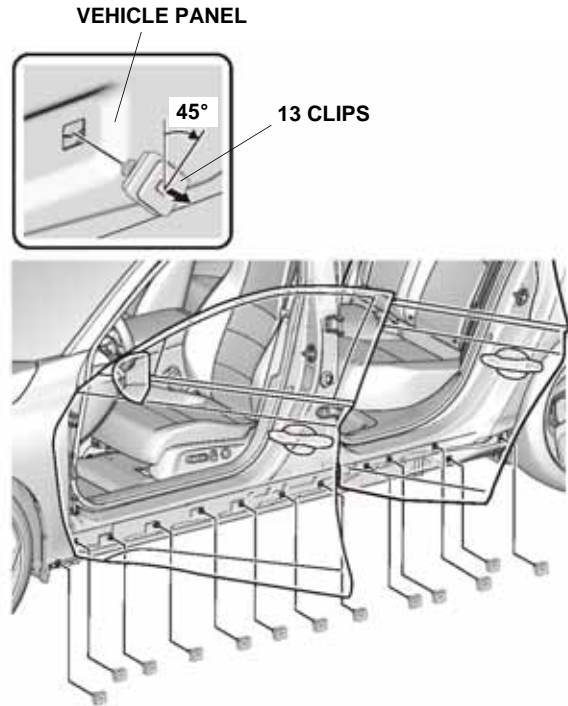

QG20305AN

6. Replace the 13 seals on the 13 clips removed in step 5.

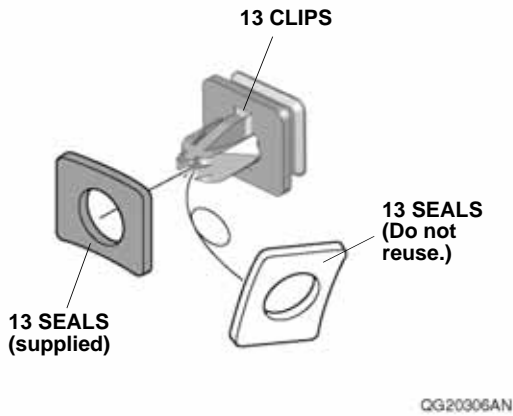

7. Install the 13 clips to the left spoiler.

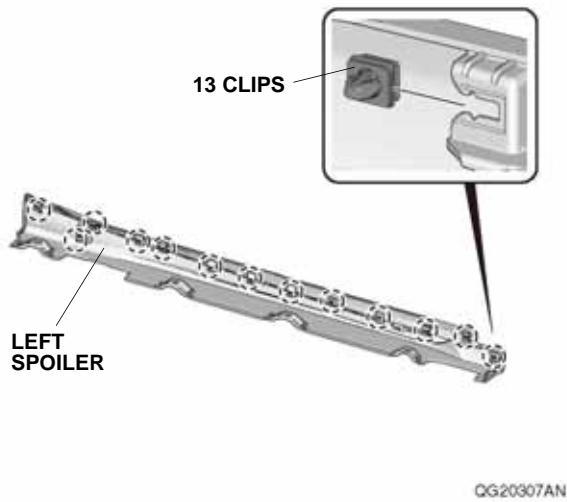

8. To prevent damage from hitting the doors while installing, apply masking tape to the left spoiler.



9. Install the left spoiler to the vehicle panel with the 13 clips. Remove the masking tape.

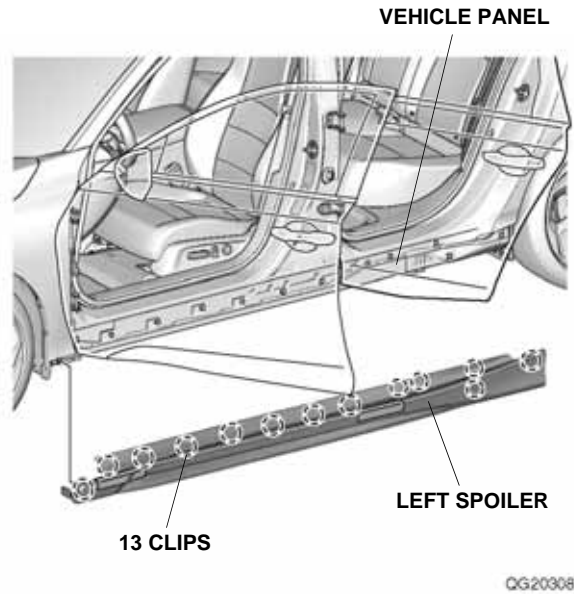

10. Close the left doors. Secure the left spoiler to the vehicle panel with the four clips removed in step 3.

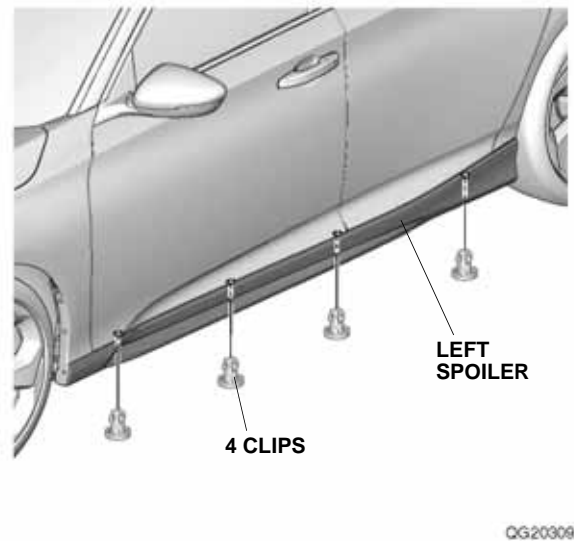

11. Secure the left spoiler to the left front inner fender with the three self-tapping screws removed in step 2.

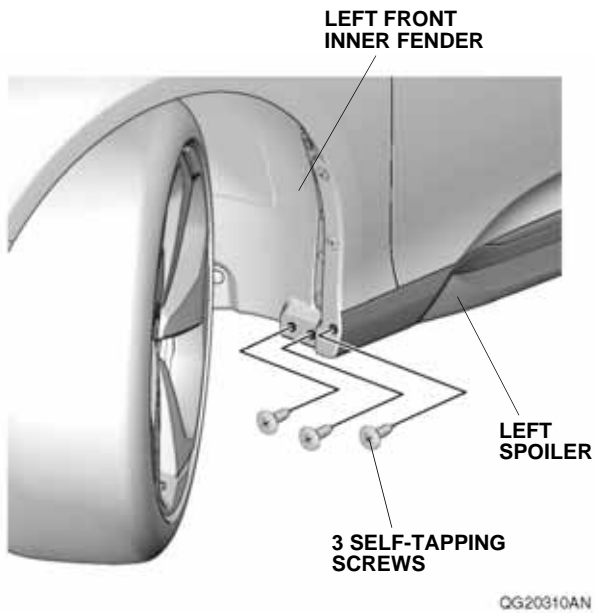

12. Turn the steering wheel fully clockwise, and repeat steps 2 through 11 on the right side of the vehicle.