



INSTALLATION INSTRUCTIONS

Accessory	Application	Publications No.
REAR BUMPER APPLIQUE P/N 08P48-TVA-100	2019 ACCORD	VERSION 1
		Issue Date OCT 2018

PARTS LIST

Rear bumper applique



Applicator

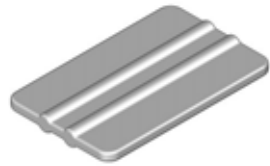

Soft sleeve



Alcohol wipe



TOOLS AND SUPPLIES REQUIRED

Shop towel

Spray bottle

3M Protective tape application solution

Masking tape

Felt-tip pen

Ruler

Illustration of the Rear Bumper Applique on the Vehicle

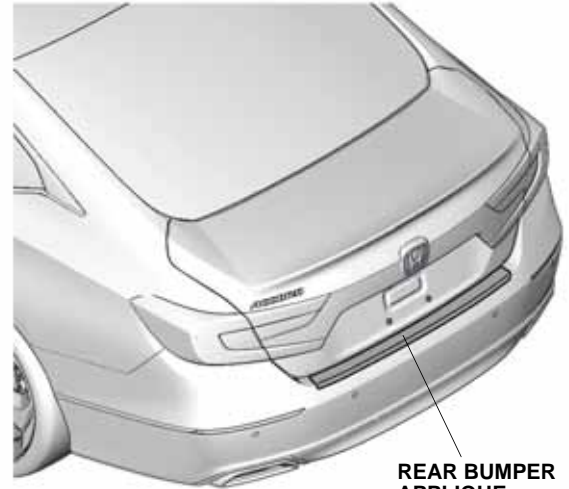

QG12701AN

INSTALLATION

Customer Information: The information in this installation instruction is intended for use only by skilled technicians who have the proper tools, equipment, and training to correctly and safely add equipment to your vehicle. These procedures should not be attempted by "do-it-yourselfers."

NOTE:

- Be careful not to damage the body paint finish.
- This rear bumper applique kit should be installed only if the ambient air temperature is 15°C (60°F) or above.
- To allow the adhesive to cure, do not wash the vehicle for 24 hours. Make sure the customer is aware of this.

Installing the Rear Bumper Applique

1. Open the trunk lid. Use the alcohol wipe to thoroughly clean the area where the rear bumper applique will attach.



2. Attach a strip of masking tape to the rear bumper as shown. Using a felt-tip pen, make a mark on the masking tape at the center of the striker.

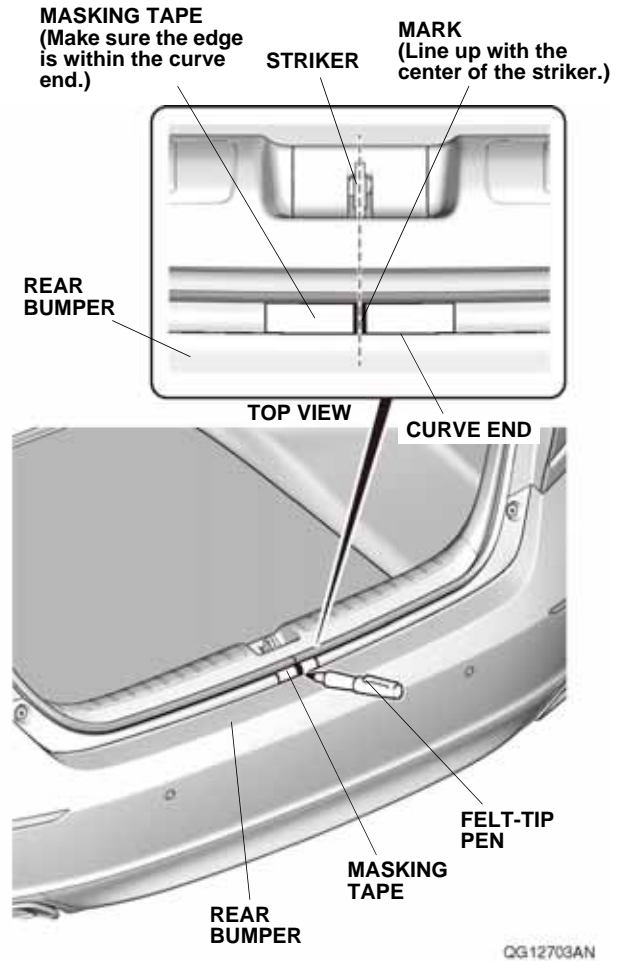

- Using a spray bottle with the 3M protective tape application solution, spray the area where the rear bumper applique will attach. Then, spray some solution on your hands.

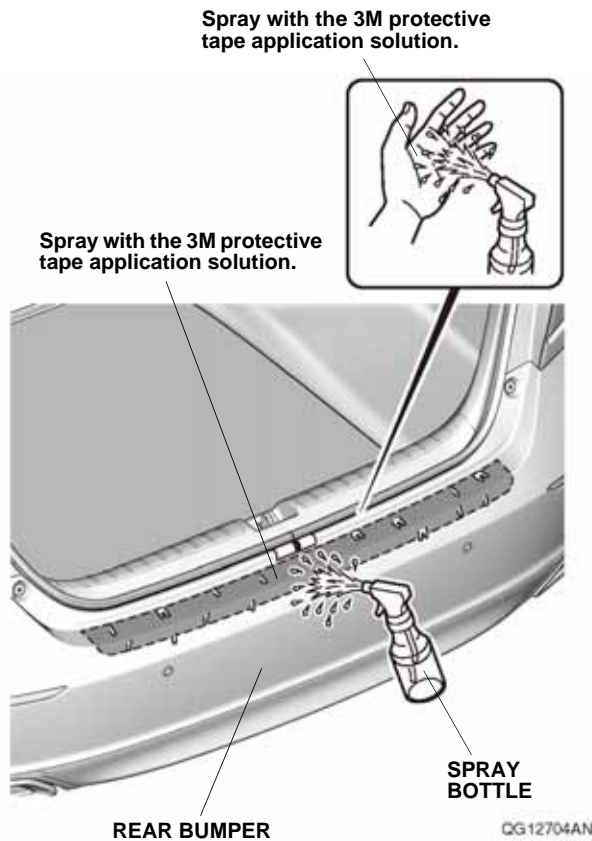

- Remove the adhesive backing from the side of the rear bumper applique.

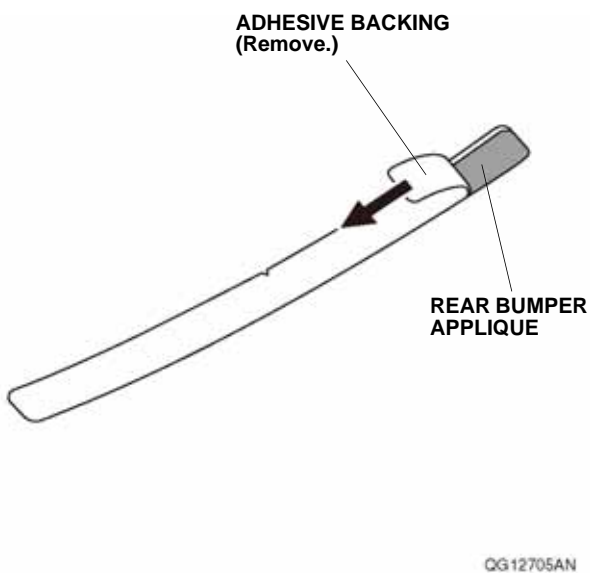

- Spray the rear bumper applique with the 3M protective tape application solution.

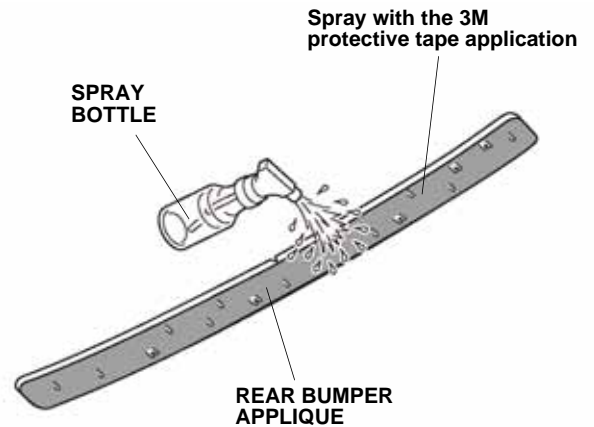

- Line up the V-notch on the rear bumper applique with the mark on the masking tape. Line up the edge of the rear bumper applique along the edge of the curved surface as shown. Smooth the rear bumper applique against the rear bumper.

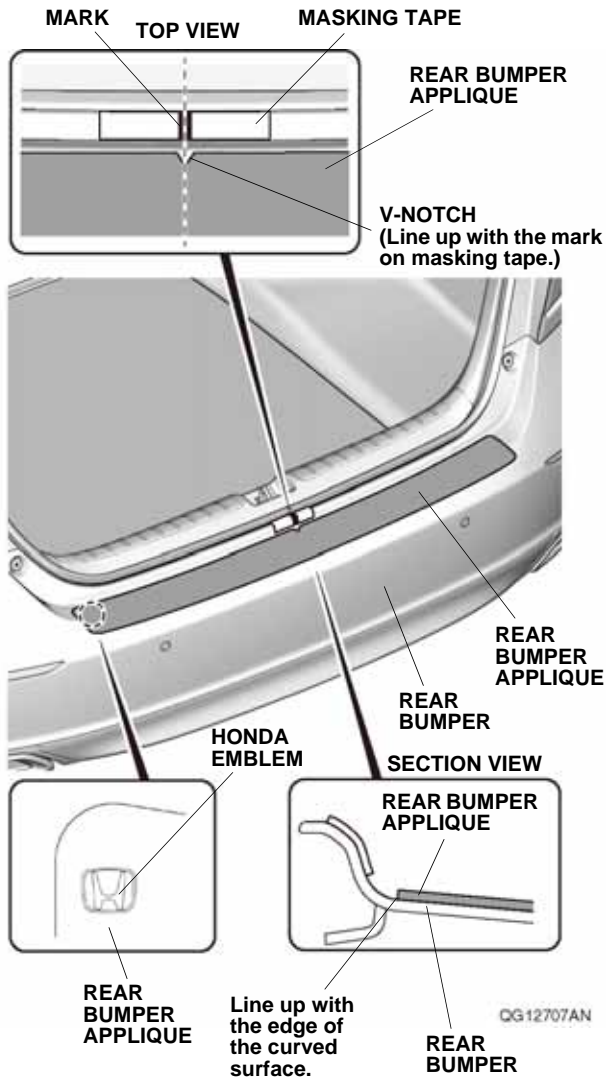

- Insert the applicator into the soft sleeve.

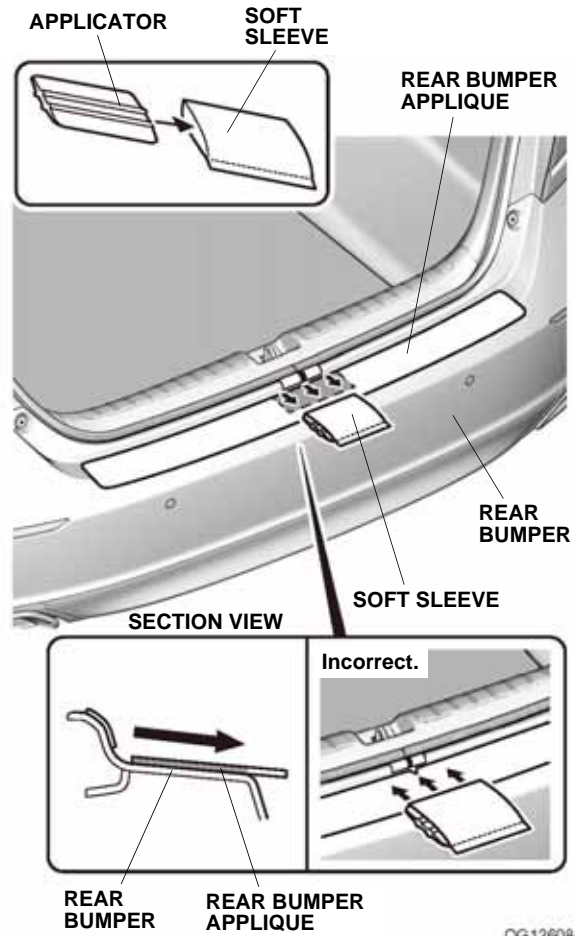

- Starting from the front and working rearward, use the soft sleeve to smooth out the center of the upper section on the rear bumper applique. Move the soft sleeve in one direction only. If you see an air bubble, stop and gently peel up that section to work out the bubble. Work slowly, and keep pressure against the rear bumper applique.

9. Starting from the center and working outward, use the soft sleeve to smooth out the left and right sides of the upper section on the rear bumper applique. Move the soft sleeve in one direction only. If you see an air bubble, stop and gently peel up that section to work out the bubble. Work slowly, and keep pressure against the rear bumper applique.

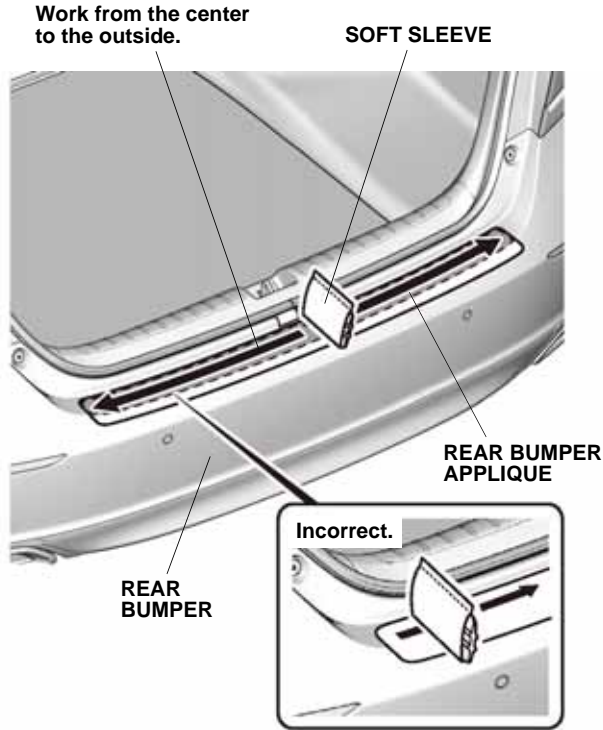

10. Slowly remove the protective film from the rear bumper applique.
NOTE: Do not pull up on the protective film.

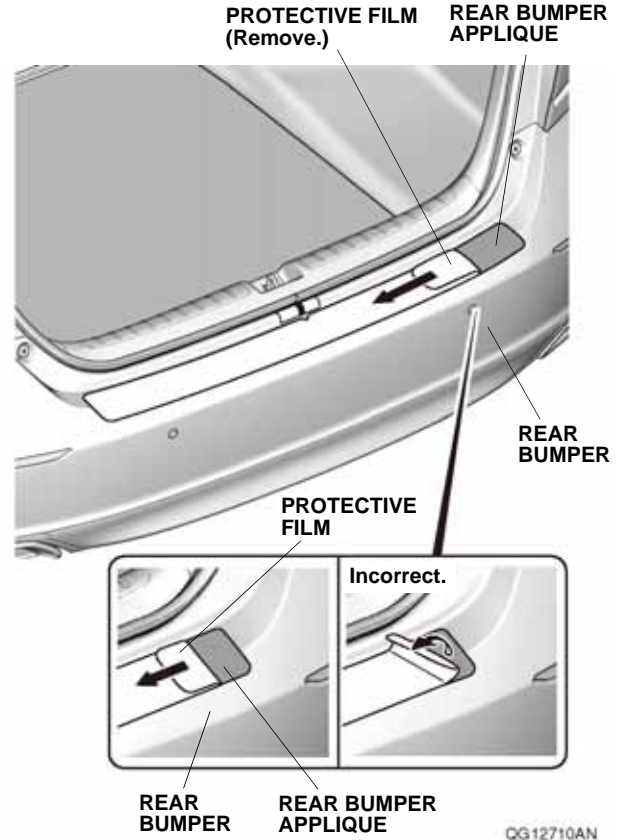

11. Repeat step 8 at the center of the lower section on the rear bumper applique.

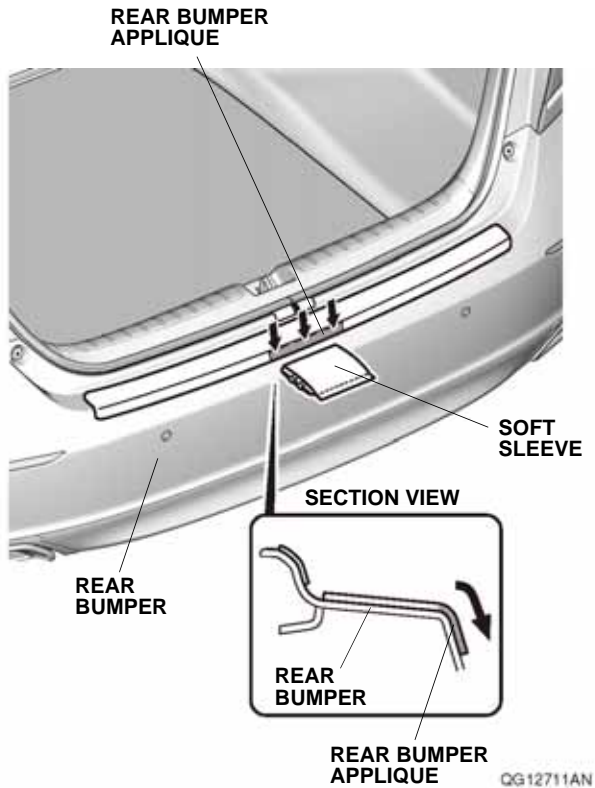

12. Repeat step 9 at the left and right sides of the lower section on the rear bumper applique.

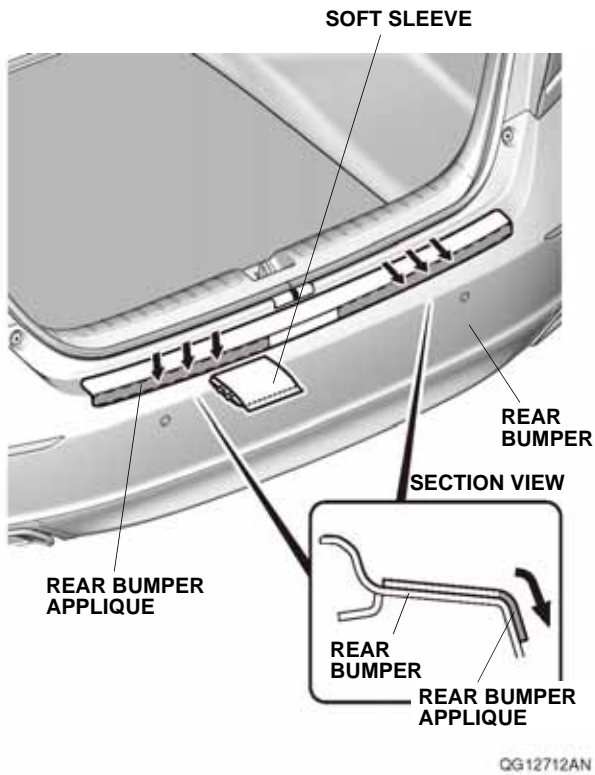

13. Using a shop towel, wipe off the 3M protective tape application solution. Allow the rear bumper applique to dry thoroughly. Remove the masking tape.

