



INSTALLATION INSTRUCTIONS

Accessory
ALL-SEASON FLOOR MATS
P/N 08P17-TVA-100

Application
2018 ACCORD

Publications No.
VERSION 1
Issue Date
OCT 2017

PARTS LIST

Driver's all-season floor mat



Passenger's all-season floor mat

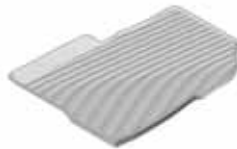

Left rear all-season floor mat



Right rear all-season floor mat



Illustration of the All-Season Floor Mats in the Vehicle

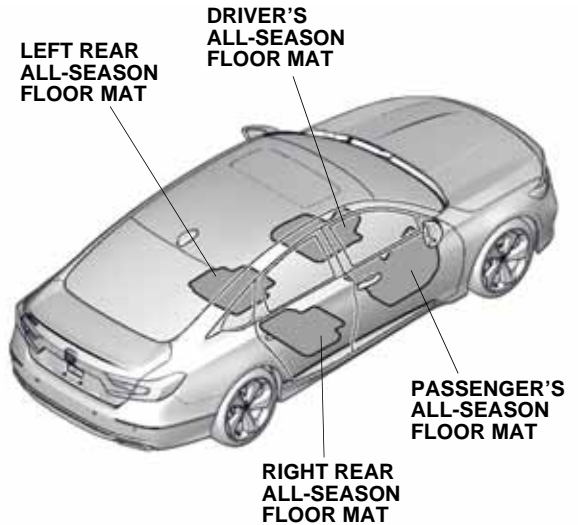

QG10701AN

INSTALLATION

NOTE:

- Before installing the floor mats, identify their installation positions.
- Connect the floor mat to the anchors to prevent it from sliding forward and possibly interfering with the pedals.
- If you remove a floor mat, make sure you re-anchor it when you put it back in your vehicle.
- If you replace a floor mat, use a factory floor mat designed to be used with the anchors.
- If you use a non-factory floor mat in the driver's footwell, make sure it fits properly and that it can be used with the anchors.
- Do not put an additional floor mat on top of the anchored floor mat. It may slide forward and possibly interfere with the pedals.
- Position the rear seat floor mats properly. If they are not properly positioned, the floor mat can interfere with the front seat functions.

Installing the All-Season Floor Mats

1. Remove the standard floor mats.

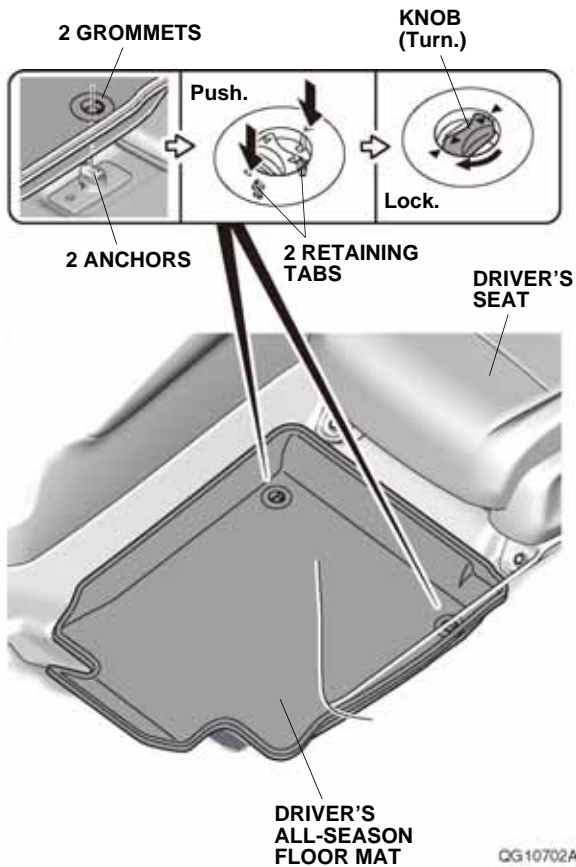

2. Place the grommets in the driver's all-season floor mat over the anchors. Push the grommets into the anchors to secure the retaining tabs, then turn the knobs 90° to secure the driver's all-season floor mat.

3. Place the passenger's all-season floor mat as shown.

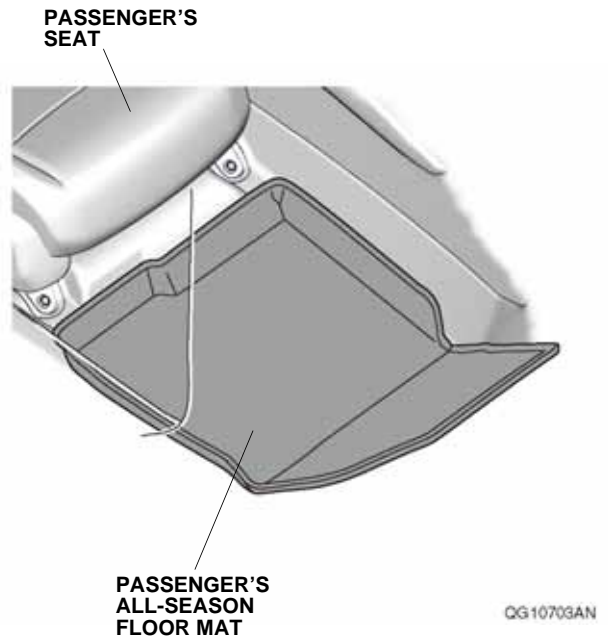

4. Place the left and right rear all-season floor mats as shown.

