



INSTALLATION INSTRUCTIONS

Accessory
DOOR EDGE FILM
P/N 08P20-T2A-100A

Application
2016 ACCORD
4-DOOR

Publications No.
VERSION 1
Issue Date
AUG 2015

PARTS LIST

Left front door edge film

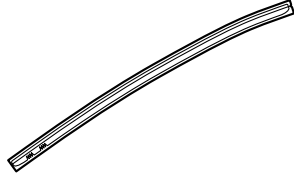

Right front door edge film

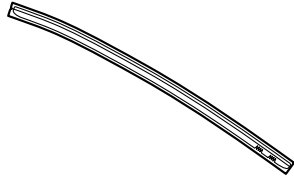

Left rear door edge film

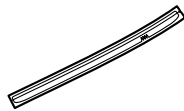

Right rear door edge film

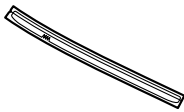

Applicator

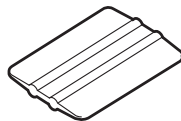

Soft sleeve

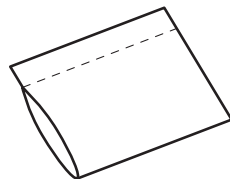

2 Alcohol swabs

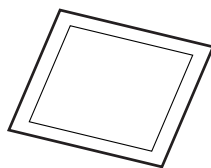

TOOLS AND SUPPLIES REQUIRED

- Shop towel
- Spray bottle
- 3M Protective tape application solution
- Ruler

Illustration of the Door Edge Film on the Vehicle

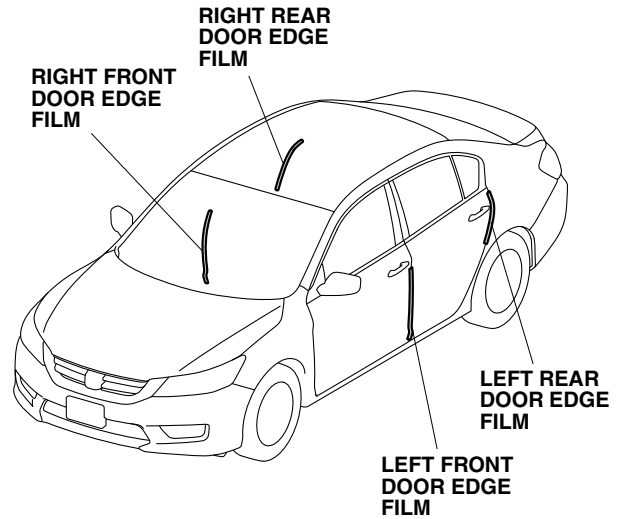

QB21002AG

INSTALLATION

Customer Information: The information in this installation instruction is intended for use only by skilled technicians who have the proper tools, equipment, and training to correctly and safely add equipment to your vehicle. These procedures should not be attempted by "do-it-yourselfers."

NOTE:

- Do not damage the paint finish.
- This kit should be installed only if the ambient air temperature is 15°C (60°F) or above.
- To allow the adhesive to cure, do not wash the vehicle for 24 hours. Please advise the customer.
- Identify each door edge film by referring to the identification mark.
- Install the door edge film before installing the accessory body side moldings.
- These instructions show the left door edge films being installed. The same procedure applies to installing the right door edge films.

1. Open the left front door. Using an alcohol swab, thoroughly clean the area where the left front door edge film will attach.

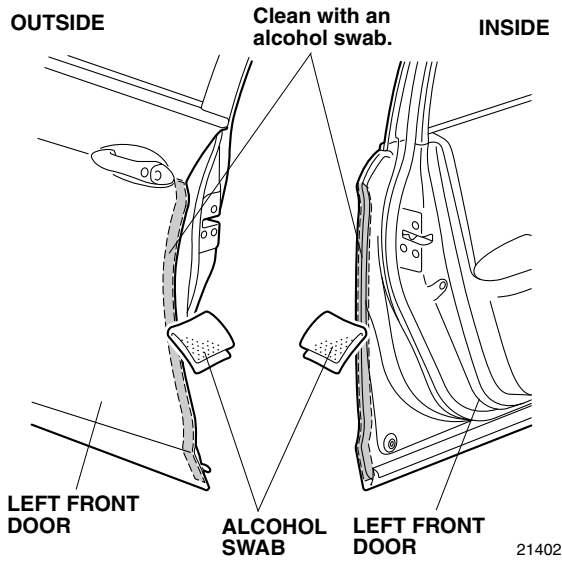

2. Close the left front door.
3. Open the left rear door. Using an alcohol swab, thoroughly clean the area where the left rear door edge film will attach.

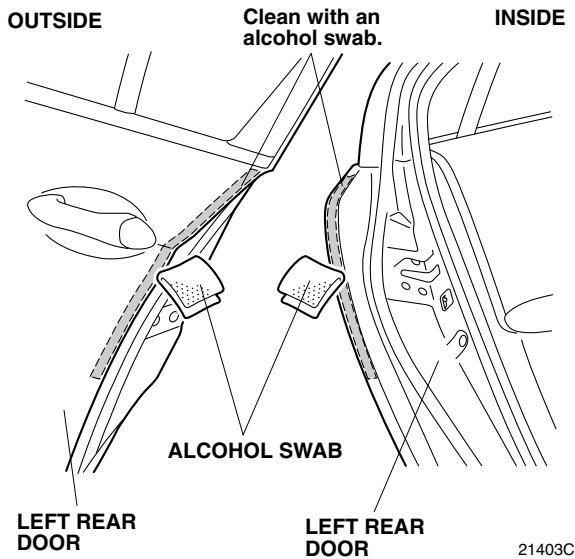

4. Close the left rear door.

5. Using a spray bottle with the 3M protective tape application solution, spray the outside of the left front door where the left front door edge film will attach. **NOTE: Do not spray the inner surface.**

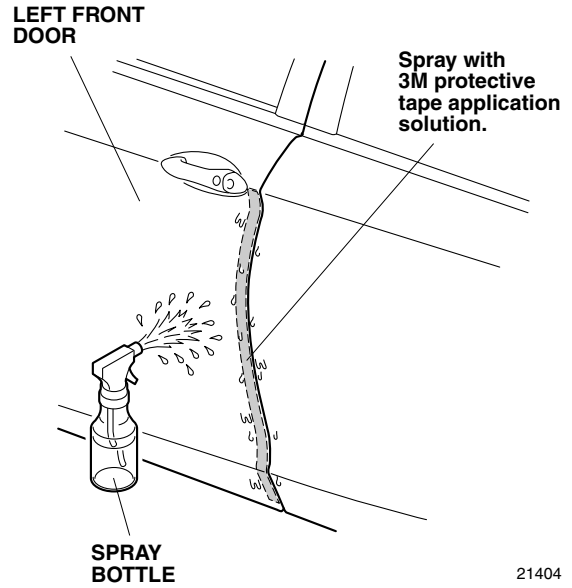

6. Open the left front door. Peel back about 50 mm (2.0 in.) of adhesive backing from the left front door edge film. Align the V-notch on the left front door edge film with the character line on the left front door.

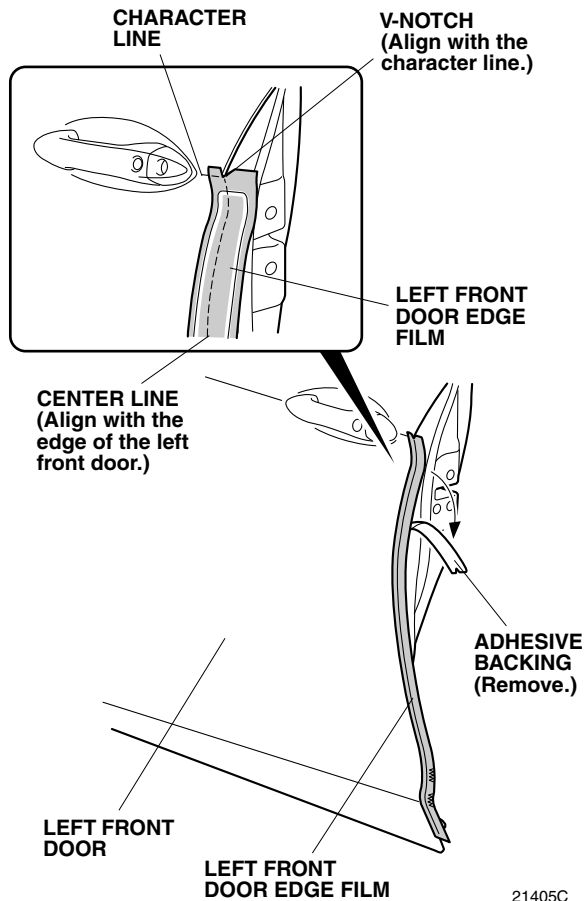

7. Align the center line on the left front door edge film with the edge of the left front door. While applying light pressure, carefully remove the adhesive backing.

8. Insert the applicator into the soft sleeve. Starting from the center and working outward, use the soft sleeve to smooth out the left front door edge film. Move the soft sleeve in one direction only.

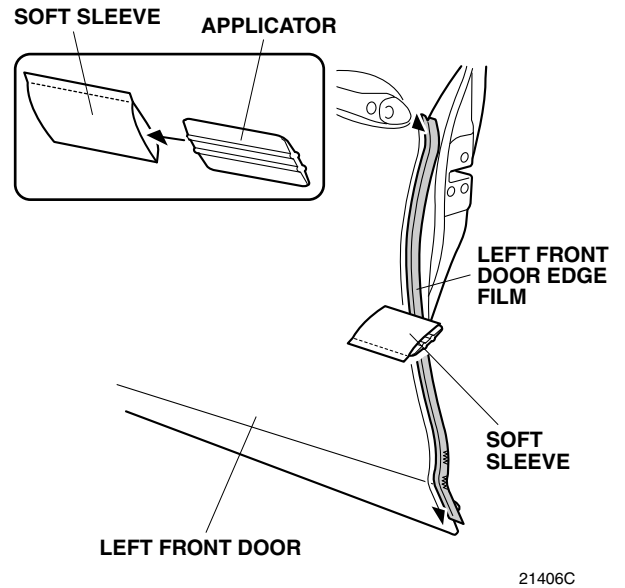

9. Slowly remove the protective film from the left front door edge film.

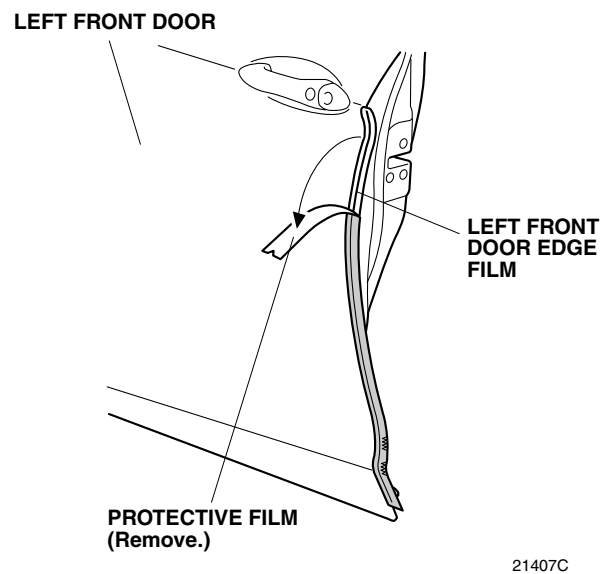

13. Open the left rear door. Peel back about 50 mm (2.0 in.) of adhesive backing from the left rear door edge film. Align the V-notch on the left rear door edge film with the left rear door as shown.

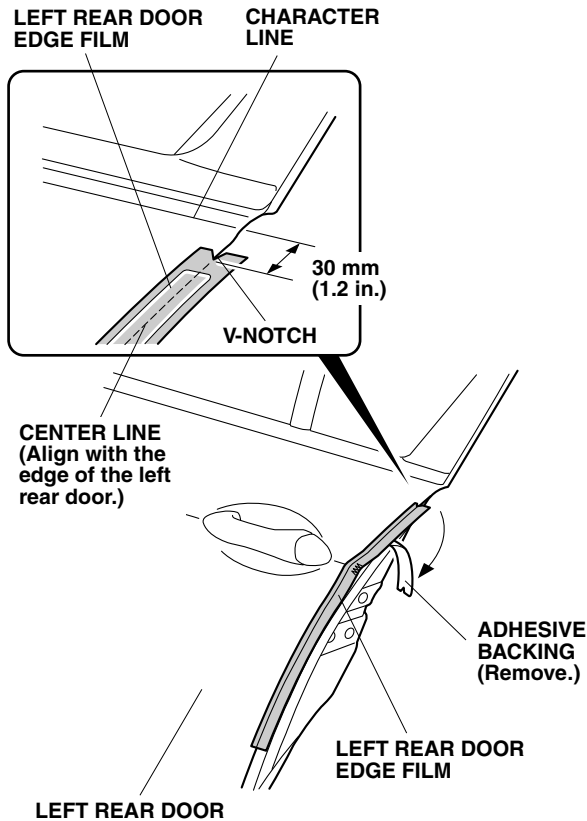

21411E

14. Align the center line on the left rear door edge film to the edge of the left rear door. While applying light pressure, carefully remove the adhesive backing.

15. Starting from the center and working outward, use the soft sleeve to smooth out the left rear door edge film. Move the soft sleeve in one direction only.

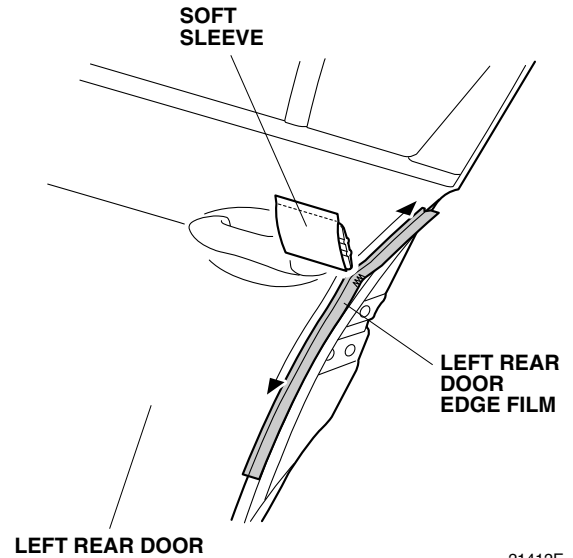

21412E

16. Slowly remove the protective film from the left rear door edge film.

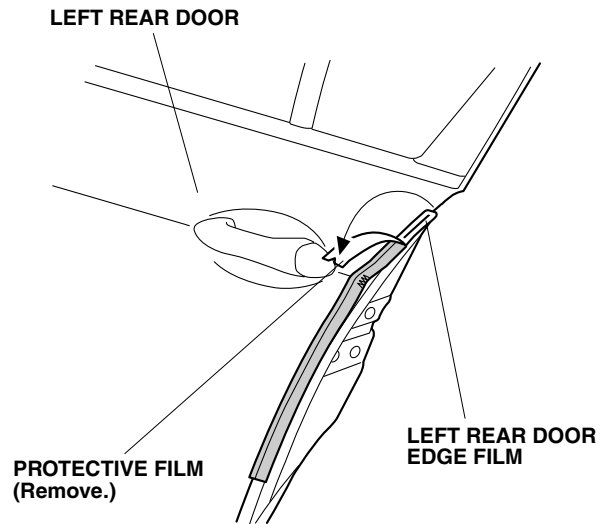

21413E

17. Starting from the center and working outward, use your finger to fold the left rear door edge film inside the left rear door. Move your finger in one direction only. Do not damage the door seam sealant.

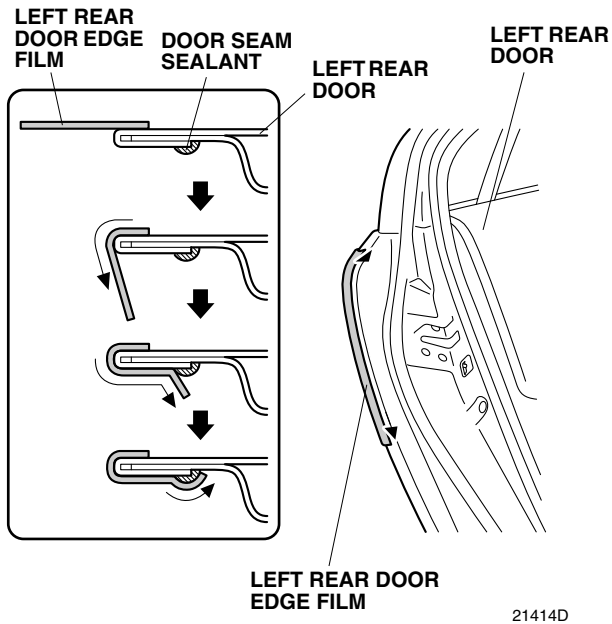

18. Using a shop towel, wipe the excess 3M protective tape application solution from the left rear door edge film. Allow the left rear door edge film to dry thoroughly.

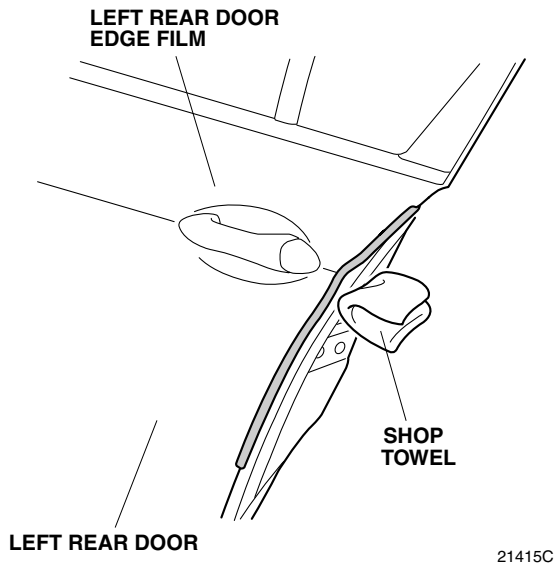

19. Repeat steps 1 through 18 to install the right door edge films on the right side of the vehicle.