



INSTALLATION INSTRUCTIONS

Accessory REAR SEAT COVERS P/N 08P32-T2A-110	Application 2014 ACCORD 4-DOOR	Publications No. All 49988
		Issue Date AUG 2013

PARTS LIST

Seat back cover

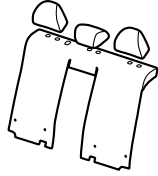

Left seat side bolster cover

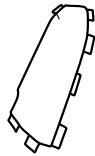

Right seat side bolster cover

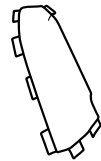

Armrest cover



Seat cushion cover

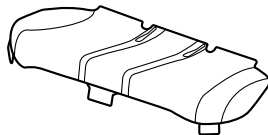
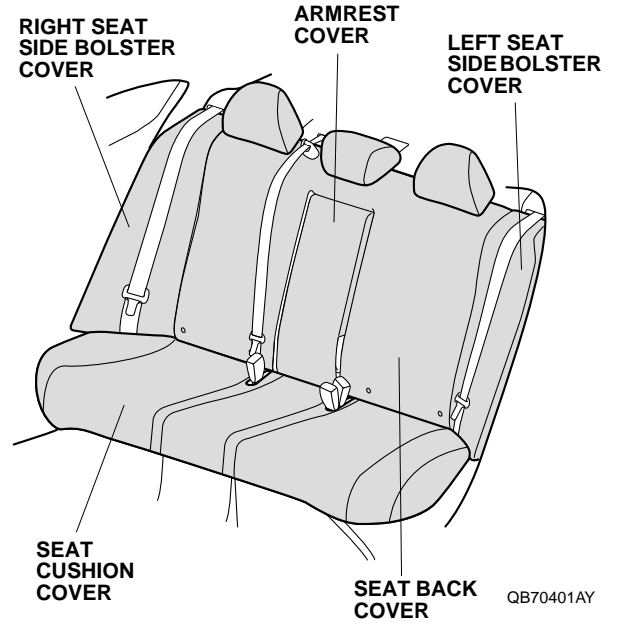

Illustration of the Rear Seat Covers in the Vehicle



INSTALLATION

Installing the Headrest Covers

1. While pressing on each headrest guide knob, remove the three headrests by pulling them upward.

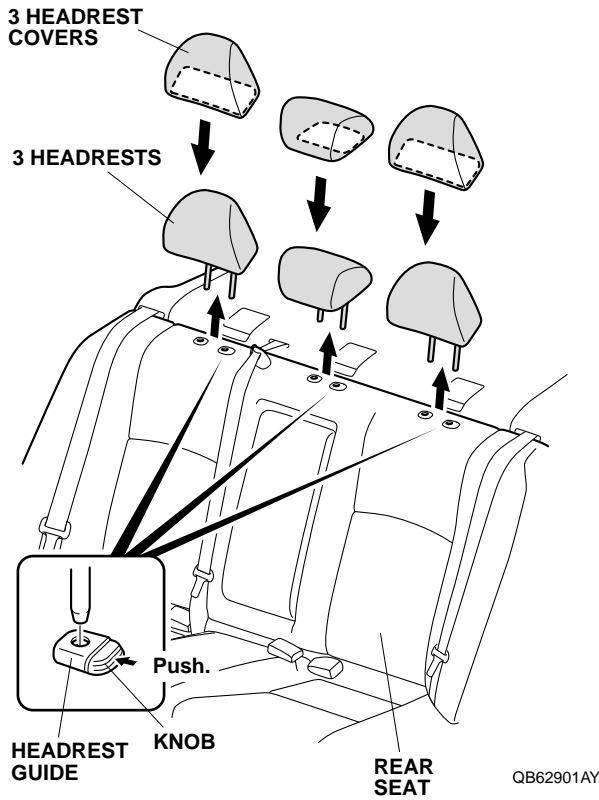

2. Fit three headrest covers over the headrests.

Installing the Rear Seat Covers

3. Pull out the center seat belt from seat belt guide.

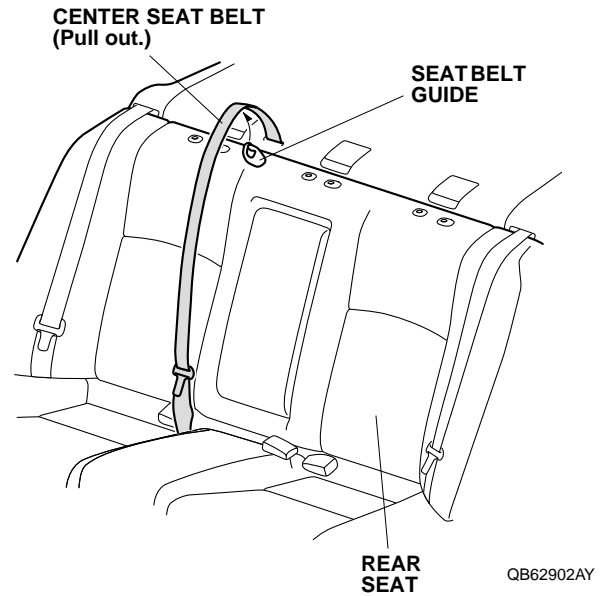

4. Open the trunk. Pull the lever, and fold the rear seat back forward.

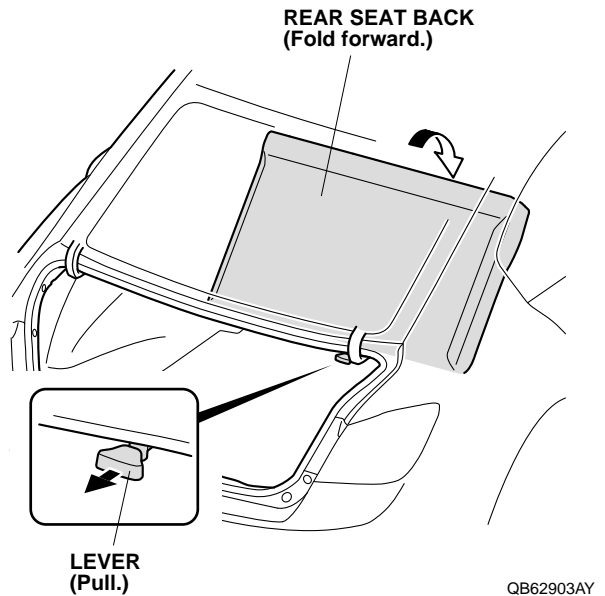

5. Fit the left seat side bolster cover onto the left seat side bolster through the seat belt. Insert the four tabs to the left seat side bolster.

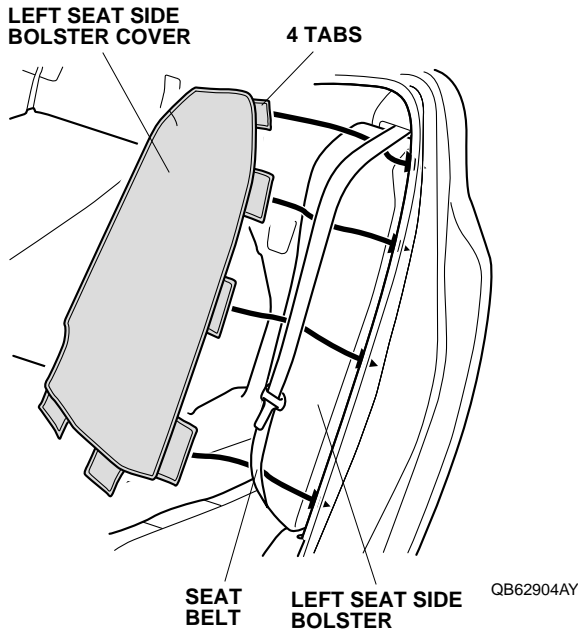

6. Insert the tab on the left seat side bolster cover to the left seat side bolster. Secure the three hook-and-loop fasteners to the left seat side bolster.

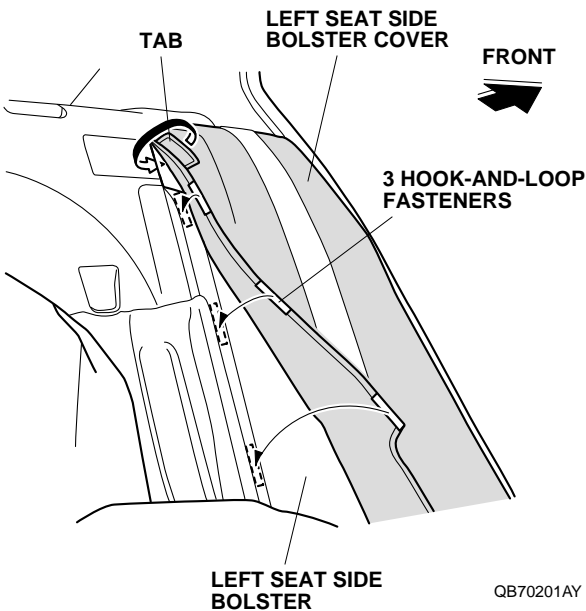

7. Insert the two tabs to the left seat side bolster.

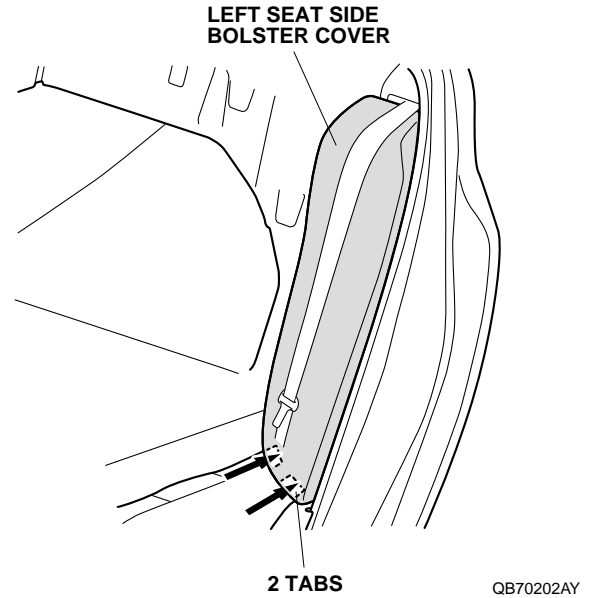

8. Repeat steps 5 through 7 to install the right seat side bolster cover on the right side of the rear seat.
9. While supporting the rear seat back, fit the seat back cover onto the rear seat back through the center seat belt.

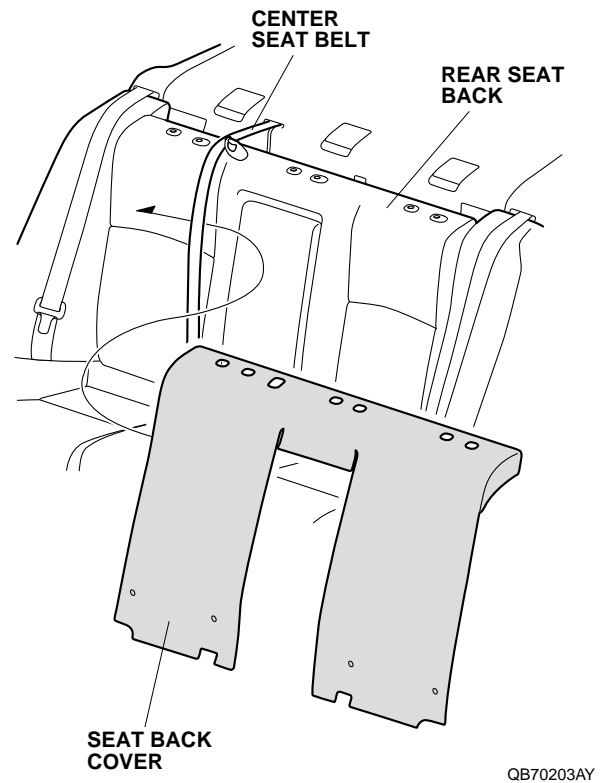

10. Secure the three hook-and-loop fasteners to the rear seat back. Raise the rear seat back and lock it to its original position.

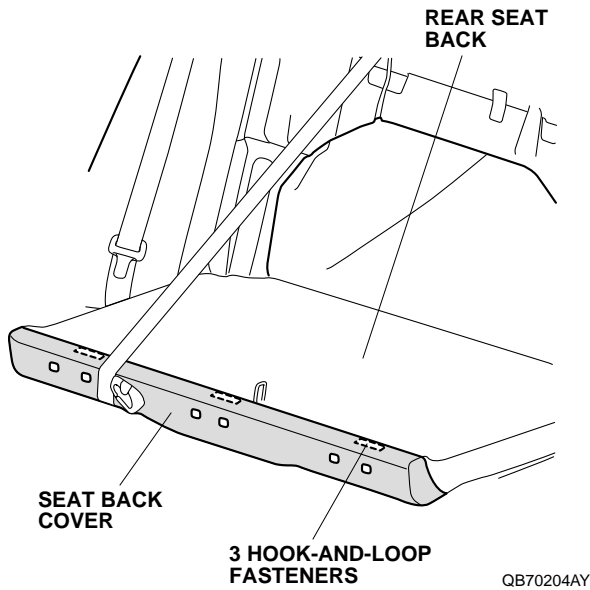

11. Insert the seat back cover under the headrest guides. Pull down the armrest, secure the hook-and-loop fastener to the rear seat back.

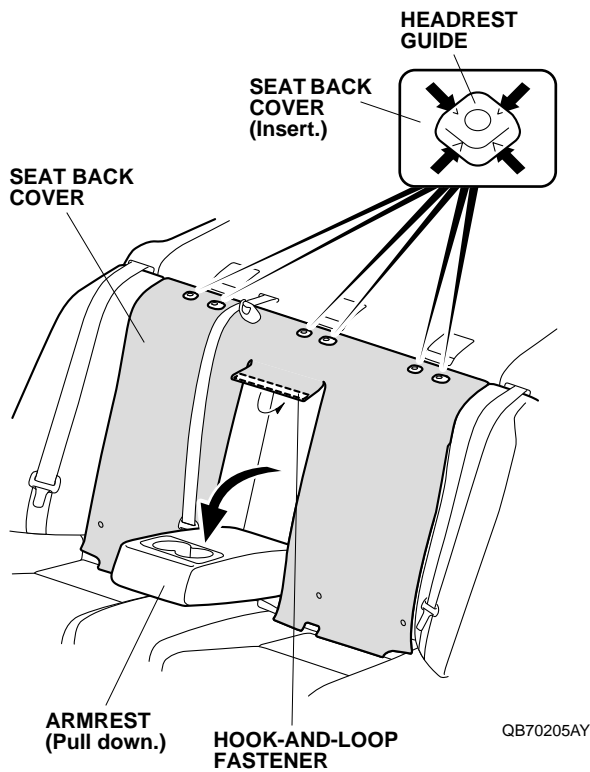

12. Insert the seat back cover between the rear seat back and the rear seat cushion, secure the four hook-and-loop fasteners to the rear seat back.

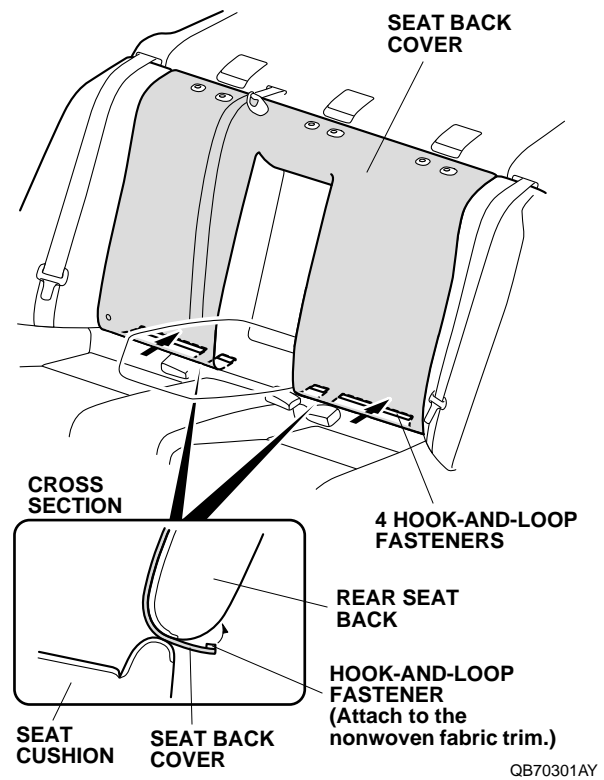

13. Install the armrest cover to the armrest.

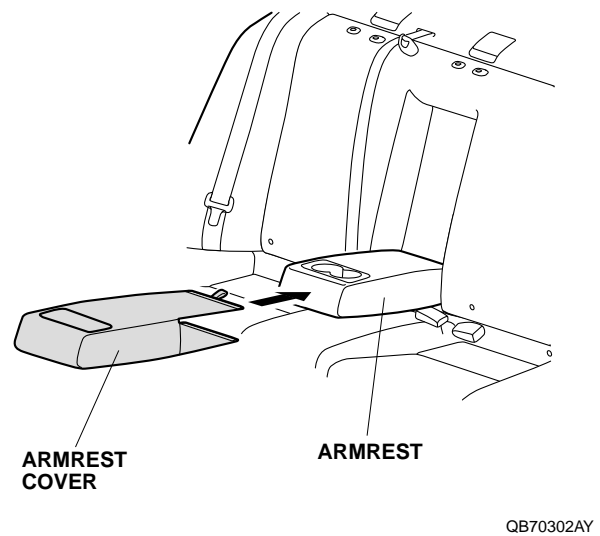

14. Raise the armrest. Pull out the armrest cover between the armrest and rear seat back, and secure the hook-and-loop fasteners on the armrest cover as shown.

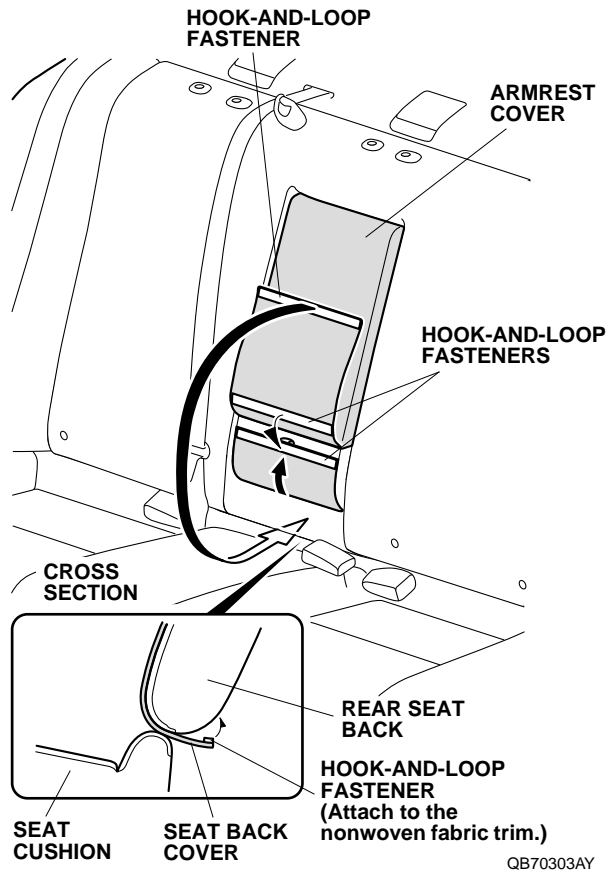

15. Insert the armrest cover between the rear seat back and the rear seat cushion, secure the hook-and-loop fastener to the rear seat back.

16. Install the seat cushion cover to the rear seat cushion. Insert three tabs to the under the rear seat cushion.

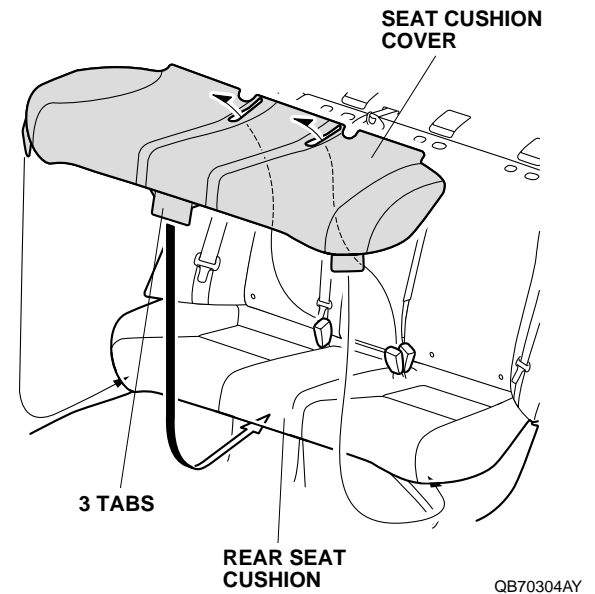

17. Insert the seat cushion cover between the rear seat back and the rear seat cushion, and secure the three hook-and-loop fasteners to the rear seat cushion.

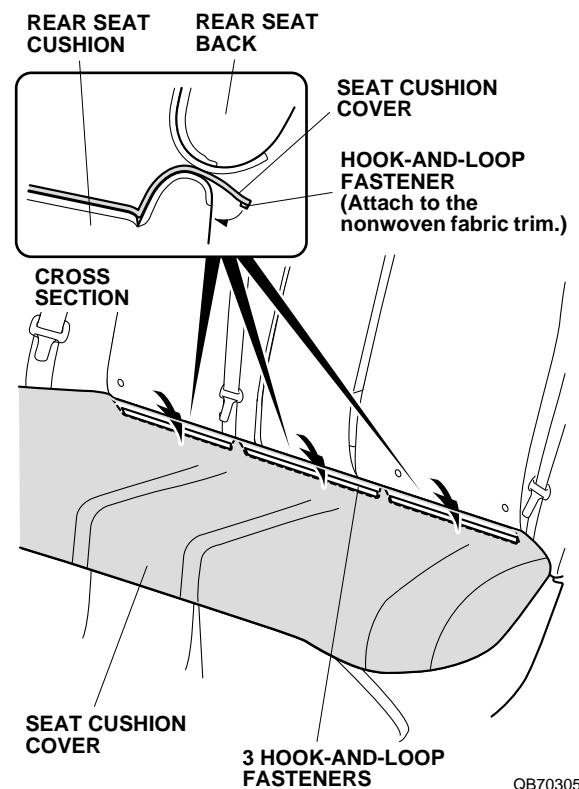

18. Secure the center seat belt to the seat belt guide.
19. Install the each three headrests to its original position.