



INSTALLATION INSTRUCTIONS

Accessory
REAR BUMPER APPLIQUE
 P/N 08P48-T2A-100

Application
2013 ACCORD
4-DOOR

Publications No.
All 13038

Issue Date
AUG 2012

PARTS LIST

Rear bumper applique



Applicator

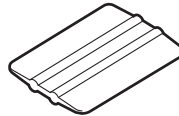

Soft sleeve

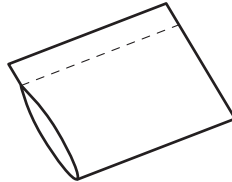

Alcohol swab

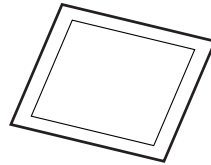

TOOLS AND SUPPLIES REQUIRED

Shop towel

Spray bottle

3M Protective tape application solution

Masking tape

Felt-tip pen

Illustration of the Rear Bumper Applique on the Vehicle

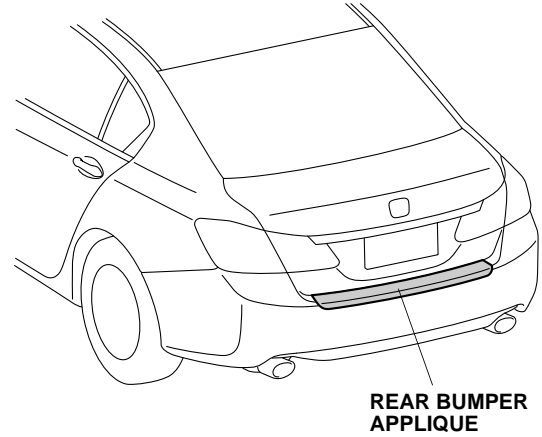

QB20608AE

INSTALLATION

Customer Information: The information in this installation instruction is intended for use only by skilled technicians who have the proper tools, equipment, and training to correctly and safely add equipment to your vehicle. These procedures should not be attempted by "do-it-yourselfers."

NOTE:

- Do not damage the paint finish.
- This rear bumper applique should be installed only if the ambient air temperature is 15°C (60°F) or above.
- To allow the adhesive to cure, do not wash the vehicle for 24 hours. Please advise the customer.

1. Open the trunk lid. Use the alcohol swab to thoroughly clean the area where the rear bumper applique will attach.

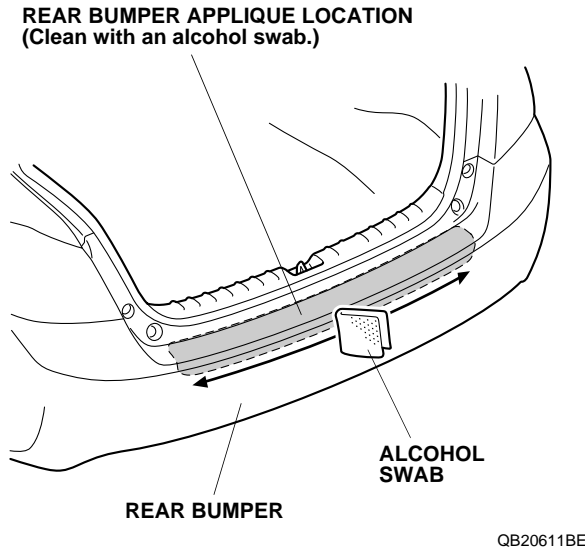

2. Attach a strip of masking tape to the rear bumper in the area shown. Using a felt-tip pen, make a mark on the tape at the center of the trunk lid anchor.

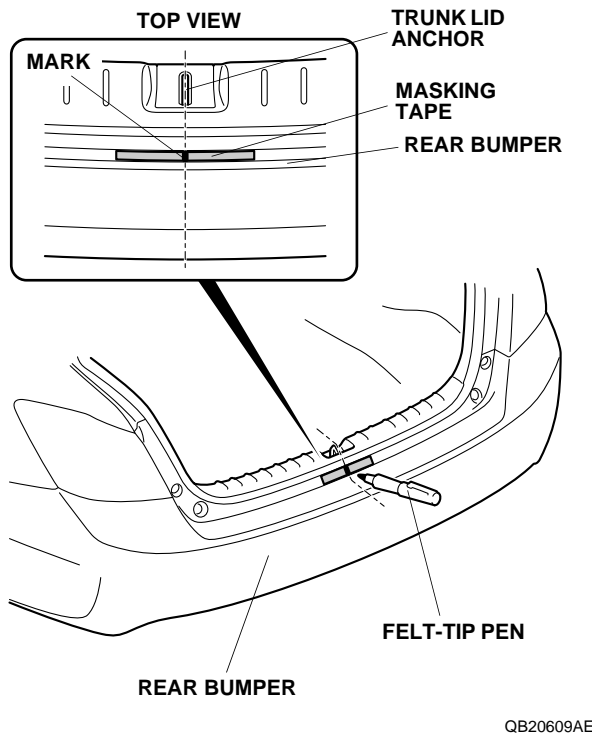

3. Align the rear bumper applique with the rear bumper and check the rear bumper applique position. Remove the rear bumper applique.

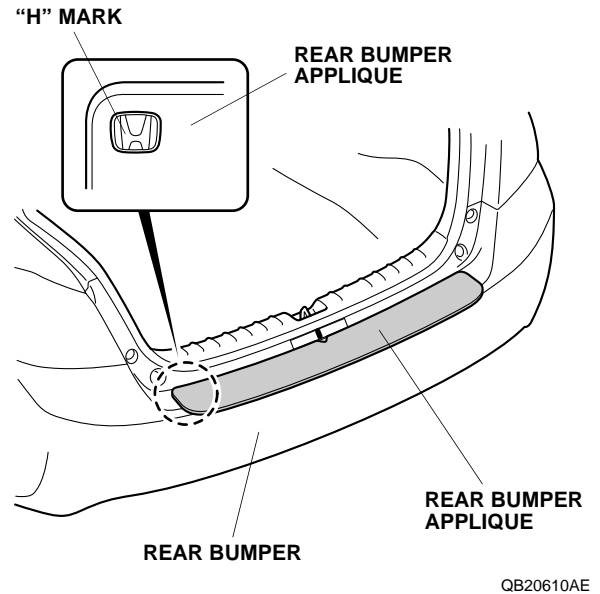

4. Using a spray bottle with the 3M protective tape application solution, spray the area where the rear bumper applique will attach. Spray some solution on your hands.

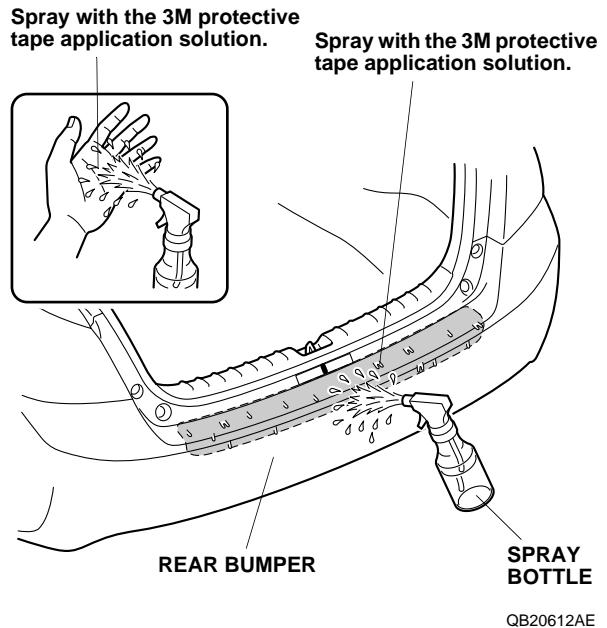

5. Remove the adhesive backing from the side of the rear bumper applique with the 3M mark.

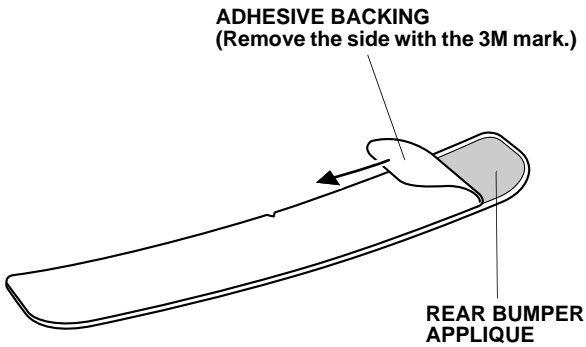

QB20613AE

6. Spray the rear bumper applique with the 3M protective tape application solution.

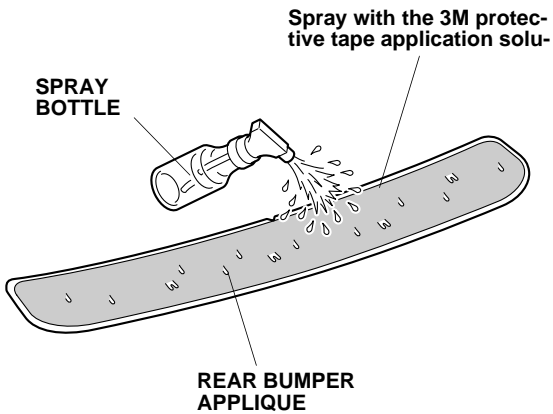

QB20614AE

7. Align the V-notch on the rear bumper applique with the mark on the masking tape. Align the edge of the applique along the edge of the curved surface as shown. Smooth the rear bumper applique against the rear bumper.

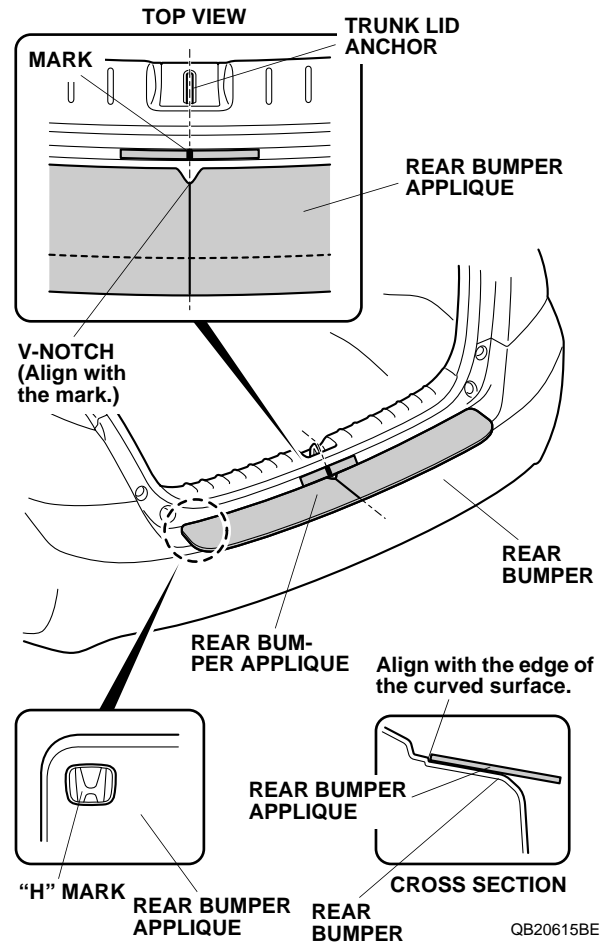

QB20615BE

8. Insert the applicator into the soft sleeve.

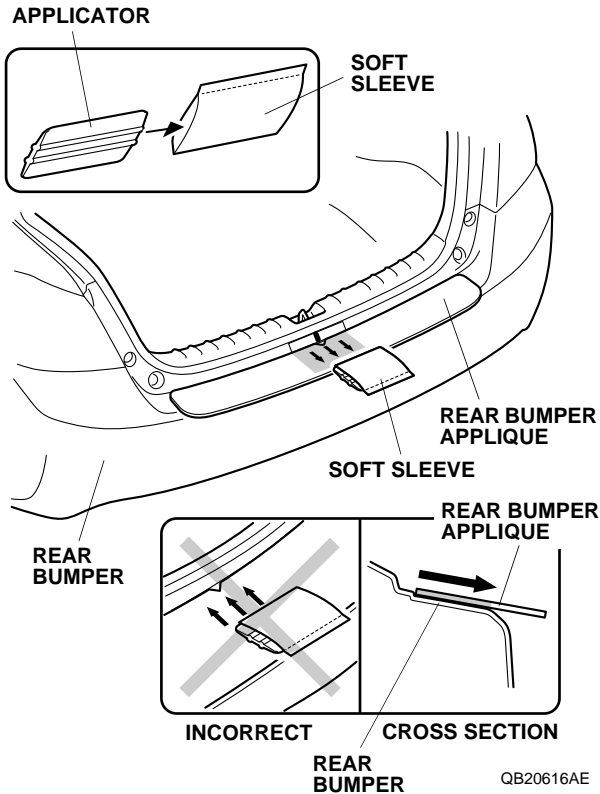

9. Starting from the front and working rearward, use the soft sleeve to smooth out the center of the upper section on the rear bumper applique. Move the soft sleeve in one direction only. If you see an air bubble, stop and gently peel up that section to work out the bubble. Work slowly and keep pressure against the rear bumper applique.

10. Starting from the center and working outward, use the soft sleeve to smooth the rear bumper applique on the left and right sides of the upper section on the rear bumper applique. Move the soft sleeve in one direction only. If you see an air bubble, stop and gently peel up that section to work out the bubble. Work slowly and keep pressure against the rear bumper applique.

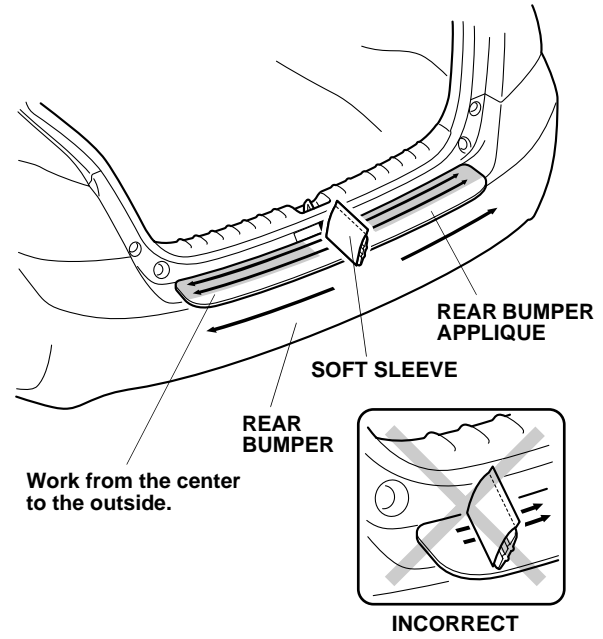

11. Slowly remove the protective film from the rear bumper applique.
NOTE: Do not pull up on the protective film.

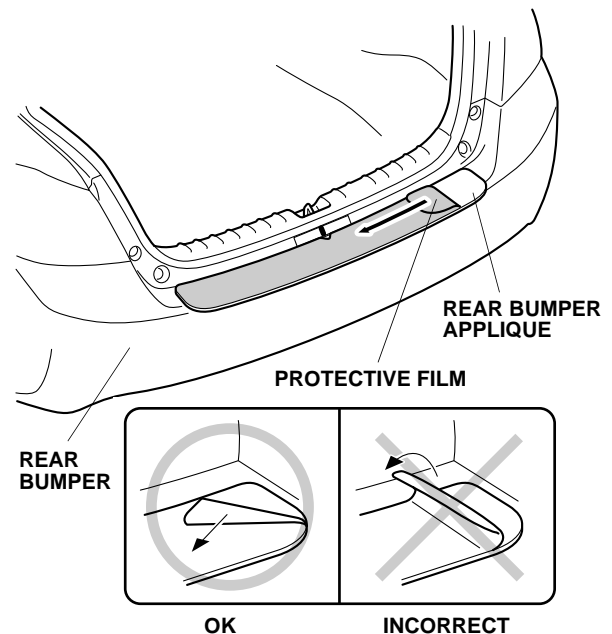

12. Repeat step 9 at the center of the lower section of the rear bumper applique.

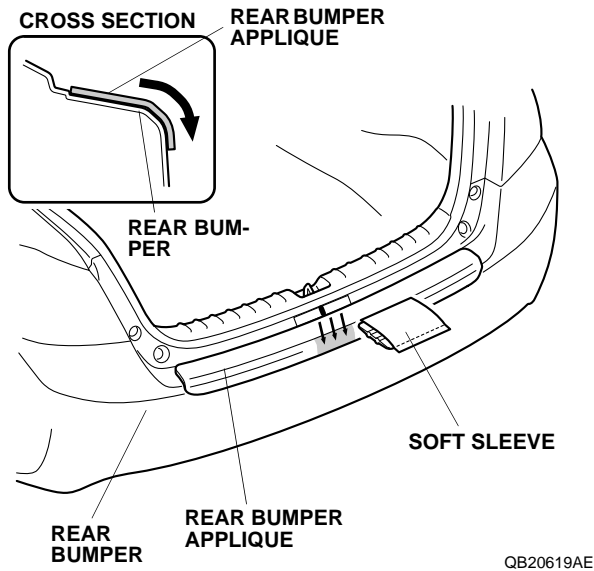

13. Repeat step 10 to smooth the left and right sides of the lower section on the rear bumper applique.

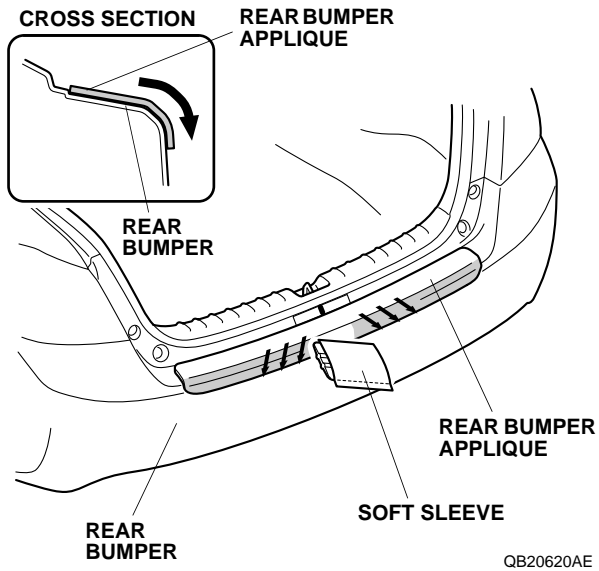

14. Using a shop towel, wipe up the 3M protective tape application solution. Allow the rear bumper applique to dry thoroughly. Remove the masking tape.

