



## INSTALLATION INSTRUCTIONS

Accessory  
ALL-SEASON FLOOR MATS

Application  
2013 ACCORD  
2 AND 4-DOOR

Publications No.  
All 13013  
Issue Date  
AUG 2012

### PARTS LIST

**All-Season Floor Mats Kit (4-Door)**  
P/N 08P13-T2A-100

Driver's all-season floor mat

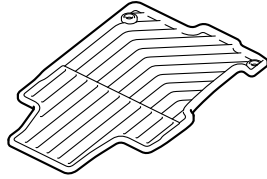

Passenger's all-season floor mat

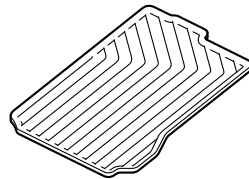

Rear all-season floor mats

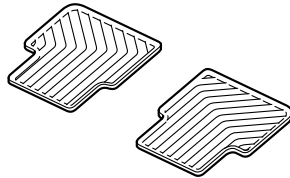

**All-Season Floor Mats Kit (2-Door)**  
P/N 08P13-T3L-100

Driver's all-season floor mat

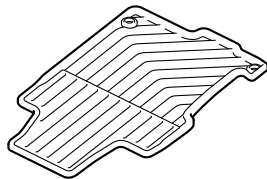

Passenger's all-season floor mat

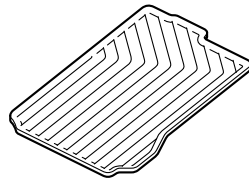

Rear all-season floor mats

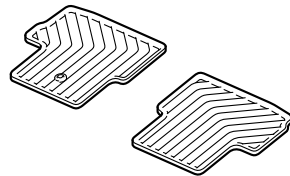

### Illustration of the All-Season Floor Mats in the Vehicle

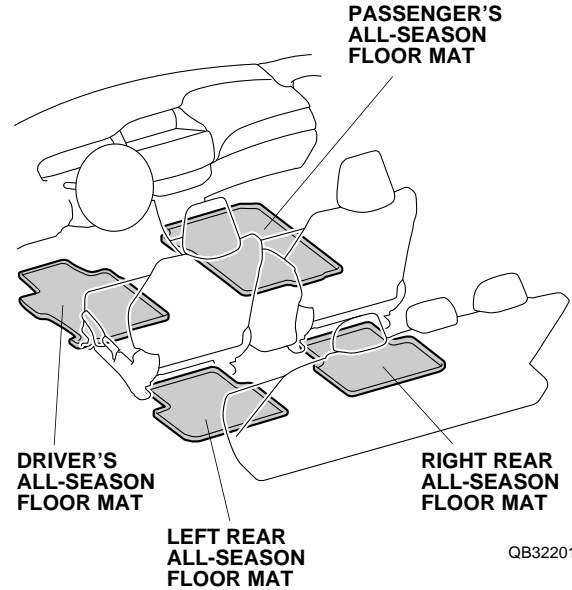

QB32201AG

### INSTALLATION

#### NOTE:

- An anchored mat is required for the driver's side of the vehicle; the anchor prevents the mat from sliding forward and possibly interfering with the pedals.
- If you remove the all-season floor mat, make sure you reanchor it when you put it back in your vehicle.
- If you replace the all-season floor mats, use factory all-season floor mats that are designed to be used with the anchor.
- If you use a non-factory mat in the driver's foot well, make sure it fits properly and that it can be used with the anchor.
- Do not put an additional mat on top of the anchored mat. It may slide forward and possibly interfere with the pedals.
- Identify each mat by the marks on the back of each mat: the mat marked "R" or "Passenger's side" goes on the right side of the vehicle; the mat marked "L" or "Driver's side" goes on the left side.

1. If equipped, remove the floor mats.
2. Install the rings in the driver's all-season floor mat over the anchors. Push on the rings into the anchors to secure the retaining tabs, then turn the knob on each anchor 90° to secure the driver's all-season floor mat.

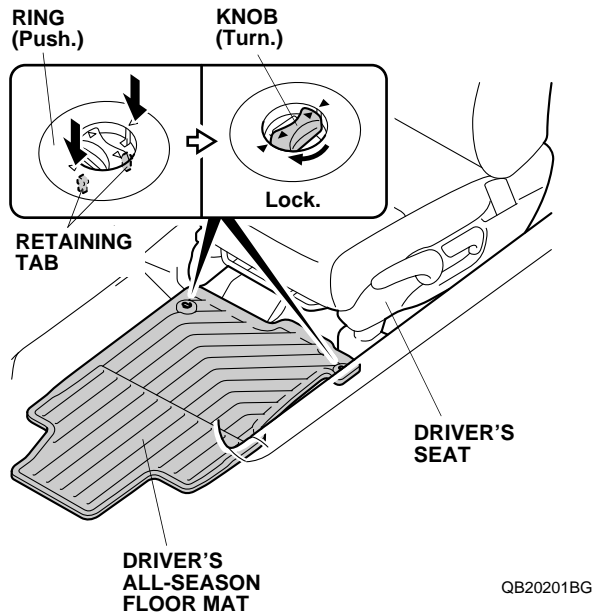

3. Place the passenger's all-season floor mat in the passenger's footwell.

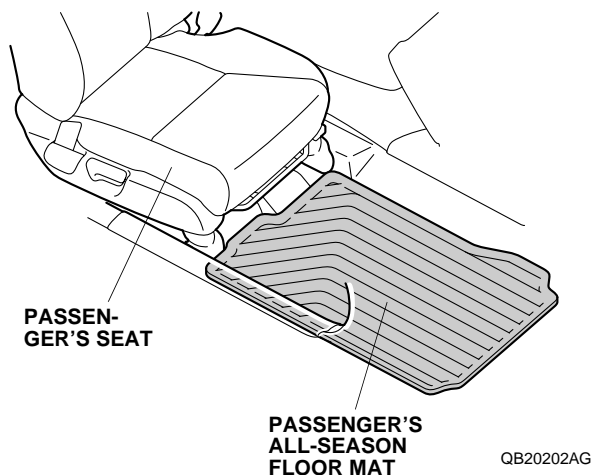

4. Place the left and right rear all-season floor mats in front of the rear seats as shown.

*4-Door:*

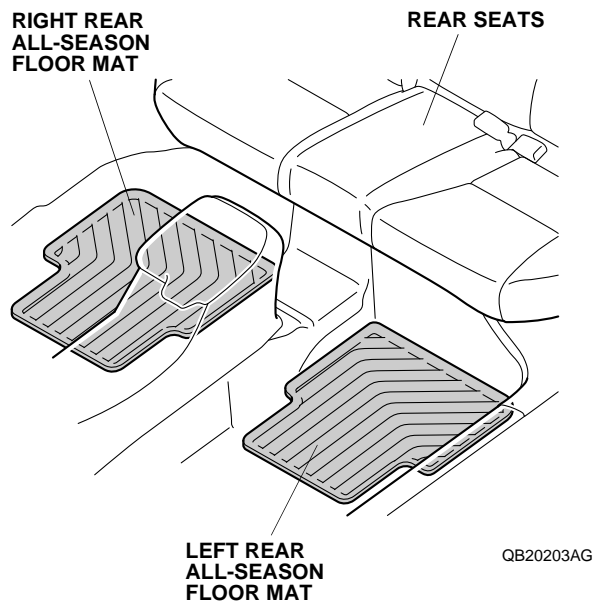

*2-Door:* Install the ring in the right rear all-season floor mat over the anchor. Push on the ring into the anchor to secure the retaining tabs, then turn the knob on the anchor 90° to secure the right rear all-season floor mat.

