



INSTALLATION INSTRUCTIONS

Accessory
SURFBOARD ATTACHMENT
P/N 08L05-TA1-100

Application
2012 PILOT

Publications No.
All 46407
Issue Date
AUG 2011

Put this information in the glove box with the vehicle owner's manual.

PARTS LIST

4 Bases

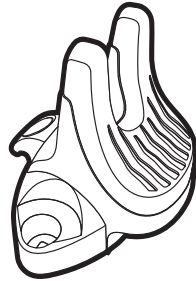

8 Knobs



8 Bolts



2 Attachment Straps

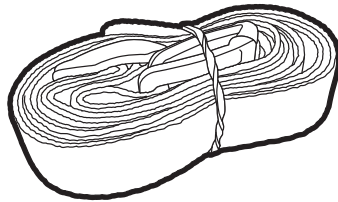

4 Metal brackets

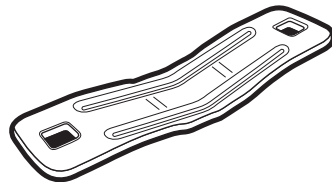

INSTALLATION

NOTE: Be careful not to damage the paint finish.

1. Loosely install a bolt, knob, and metal bracket to a base.

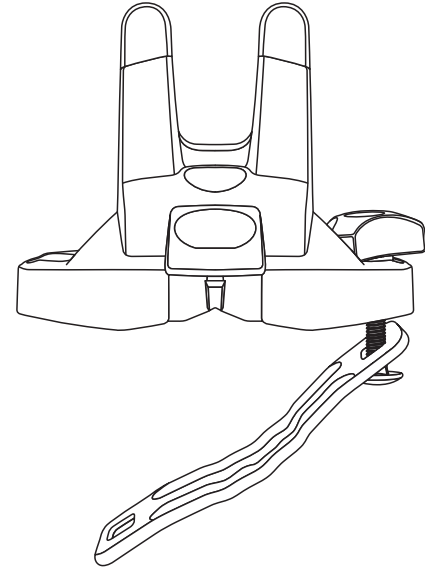

2. Position the base on the crossbar. Loosely install a bolt and knob as shown.

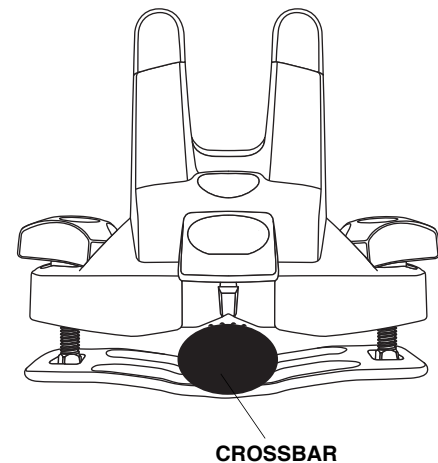

3. Repeat steps 1 and 2 for the three remaining bases.

4. Center the surfboard upside down on the roof of the vehicle with the tail toward the front of the vehicle.
NOTE: When mounting two boards, place the second board on top of the first.

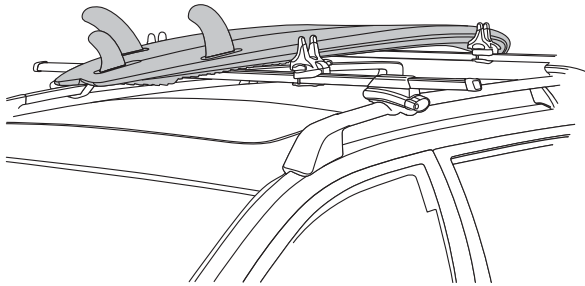

5. Adjust the position of the bases so that the bottom of the surfboard rests on the rubber part of the bases. Tighten all knobs firmly and evenly.
NOTE: The crossbars must be at least 24 in. (610 mm) apart for safe use.

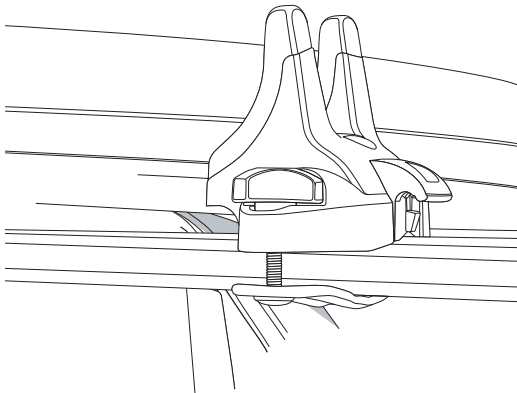

6. Slide the buckle on an attachment strap into the clip on the base.
NOTE: For proper alignment, the buckle must be fully inserted into the clip as shown.

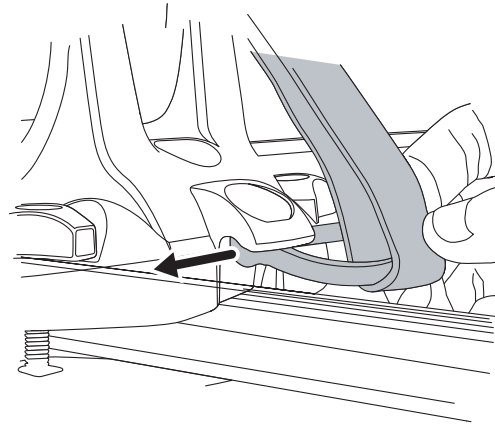

7. Rotate the buckle up to lock it to the base. Attach the buckle at the other end of the strap to the other base and lock it in place.

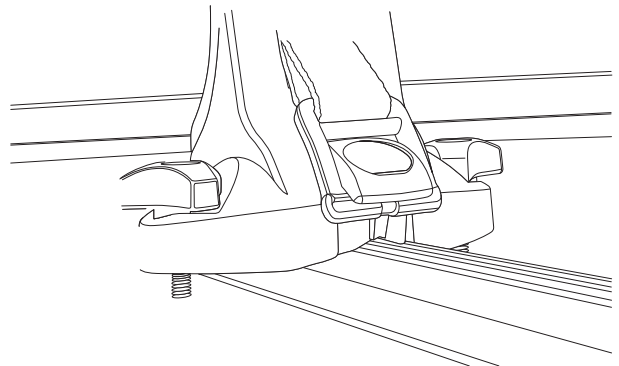

8. Repeat steps 6 and 7 to install the other strap.

9. Pull the ends of the attachment straps to secure the surfboard to the carrier. Make certain all mounting hardware is secure, then tighten as necessary.
NOTE: Be careful not to overtighten the attachment straps as you could damage the surfboard.

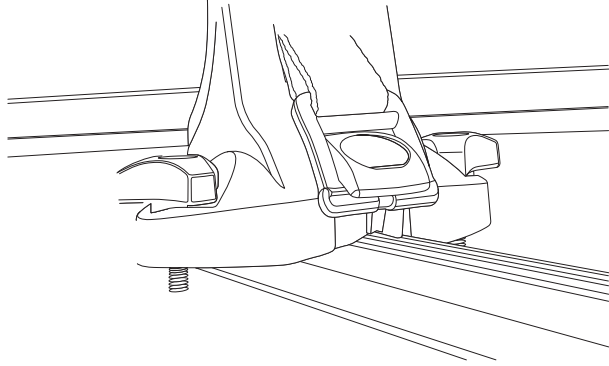

Surfboard Removal

1. Open the latches to loosen the attachment straps.

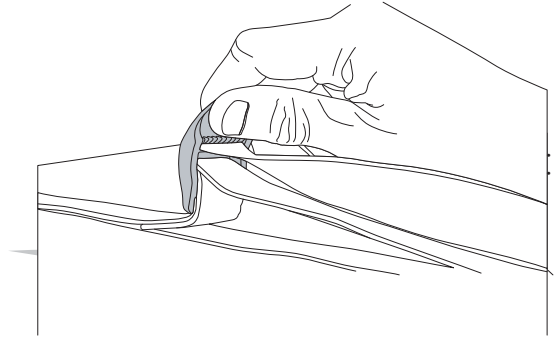

2. Rotate the buckles down to unlock the attachment straps, and slide the buckles out of the bases.

