



INSTALLATION INSTRUCTIONS

Accessory

SECURITY SYSTEM (LX)

Application

2009 ODYSSEY

Publications No.

All 40247

Issue Date

AUG 2008

PARTS LIST

**Security System Attachment:
P/N 08E55-SHJ-100**

Control unit bracket

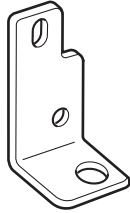

Security harness

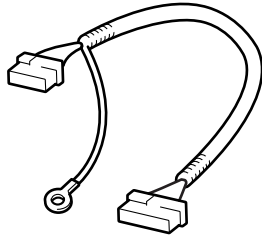

Flange bolt, 6 x 16 mm



Flange nuts, 6 mm



6 Wire ties

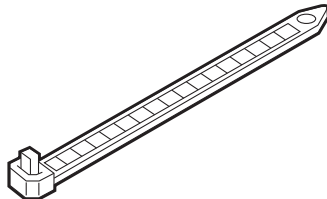

2 Wire ties with clip

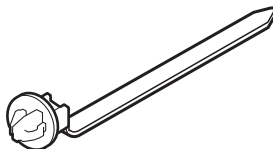

Ground bolt

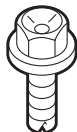

Fuse (2 A)

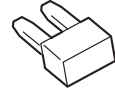

Fuse label

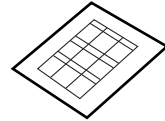

Accessory User's Information Manual

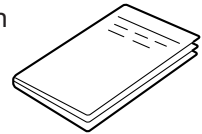

**Unit kit (sold separately):
P/N 08E51-SHJ-100**

Control unit

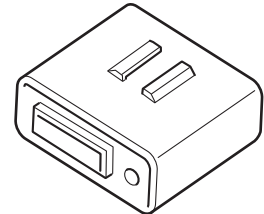

Security label

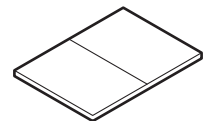

Microphone

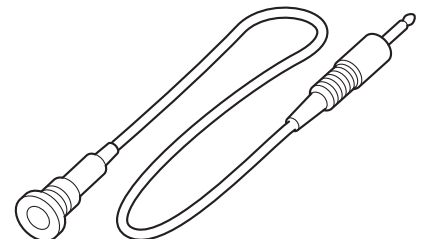

TOOL AND SUPPLIES REQUIRED

- Phillips screwdriver
- Flat-tip screwdriver
- Felt-tip pen
- Tape measure
- 10 mm Combination wrench
- 10 mm Socket
- Ratchet
- Eye protection (face shield, safety goggles, etc.)
- 3 mm and 8 mm Drill bit
- Drill

Illustration of the Security System Installed on the Vehicle

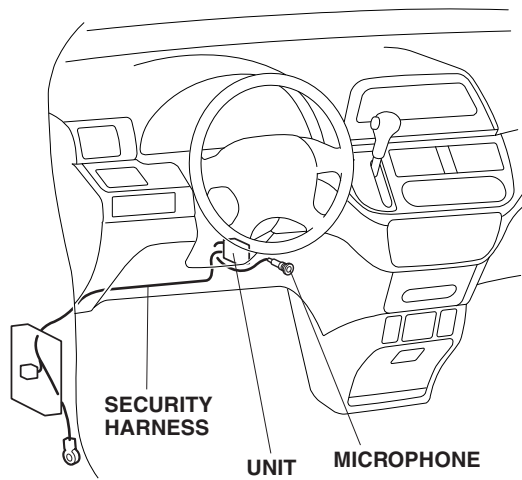

INSTALLATION

Customer Information: The information in this installation instruction is intended for use only by skilled technicians who have the proper tools, equipment, and training to correctly and safely add equipment to your vehicle. These procedures should not be attempted by "do-it-yourselfers."

1. Make sure you have the anti-theft code for the radio, and write down the radio station presets.
2. Disconnect the negative cable from the battery.

3. Remove the right side lower cover (one clip, one retaining clip, and one stud).

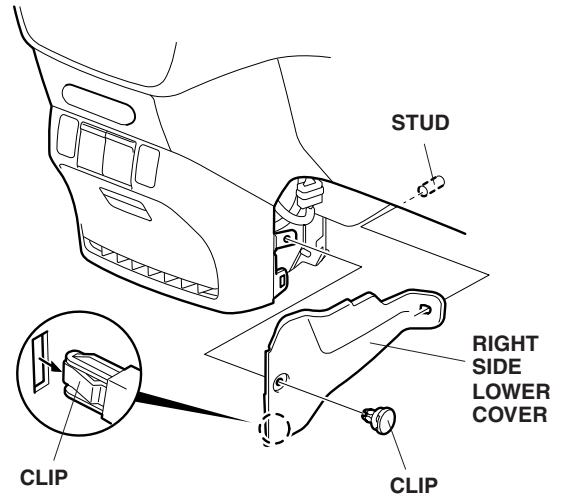

4. Remove the left side lower cover (one clip, one retaining clip, and one stud).

