



INSTALLATION INSTRUCTIONS

Accessory

SPLASH GUARDS
P/N 08P00-SHJ-101

Application

2007 ODYSSEY

Publications No.

All 33039-33598

Issue Date

AUG 2006

PARTS LIST

Right front splash guard

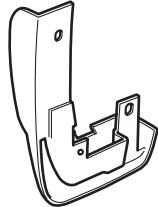

Left front splash guard

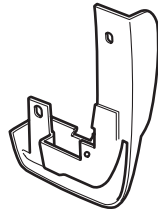

Right rear splash guard

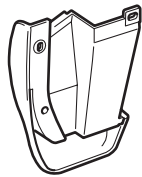

Left rear splash guard



6 Self-tapping screws



2 Spring nuts



2 Square head grommets

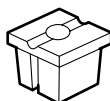

TOOLS REQUIRED

Stubby Phillips screwdriver

Pushpin

Floor Jack

INSTALLATION

NOTE:

- These instructions show the left splash guards being installed. The same procedure applies to installing the right splash guards.
- Clean and wax the areas to be covered with a high-quality paste wax.

Installing the Front Splash Guards

1. Turn the steering wheel all the way counter clockwise to provide access to the left front fenderwell.
2. Remove the two self-tapping screws from the left front inner fender.

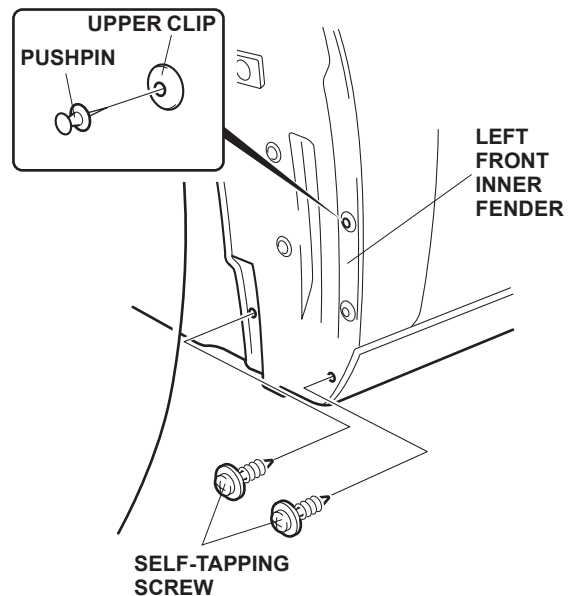

3. Using a pushpin, make a small hole through the center of the upper clip.

4. Install the left front splash guard using the two self-tapping screws removed in step 2, and one self-tapping screw supplied with the kit. Do not tighten the self-tapping screws yet.

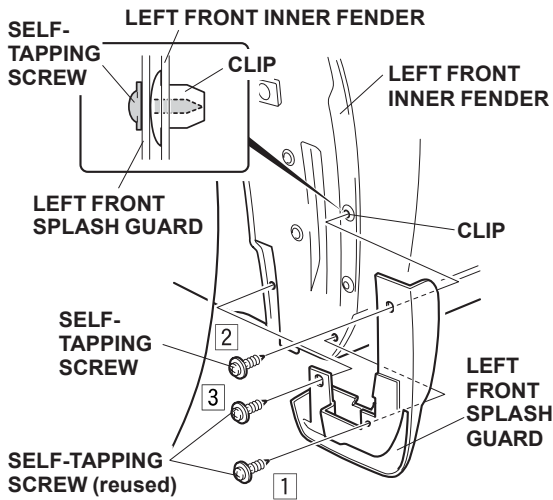

5. While holding the left splash guard against the fender, tighten the self-tapping screws in the order shown.
6. Turn the steering wheel all the way clock wise and repeat steps 2 through 4 to install the right front splash guard.

Installing the Rear Splash Guard

7. Using a floor jack, lift up the left rear side of the vehicle according to the service manual.
8. Remove the self-tapping screw from the rear bumper. Using a pushpin, make a hole through the center of the recess.

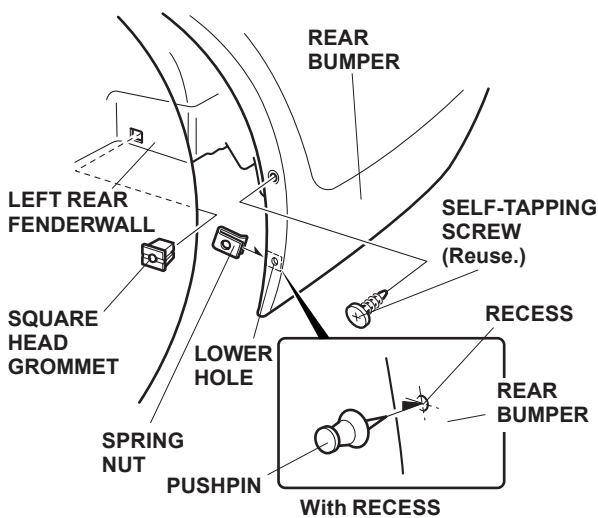

9. Install one square head grommet into the hole in the left rear fenderwall. Slide one spring nut over the hole you made in step 8 in the rear bumper.

10. Position the left rear splash guard on the left rear fenderwall and rear bumper, and loosely install one self-tapping screw you removed, and the two self-tapping screws supplied with the kit.

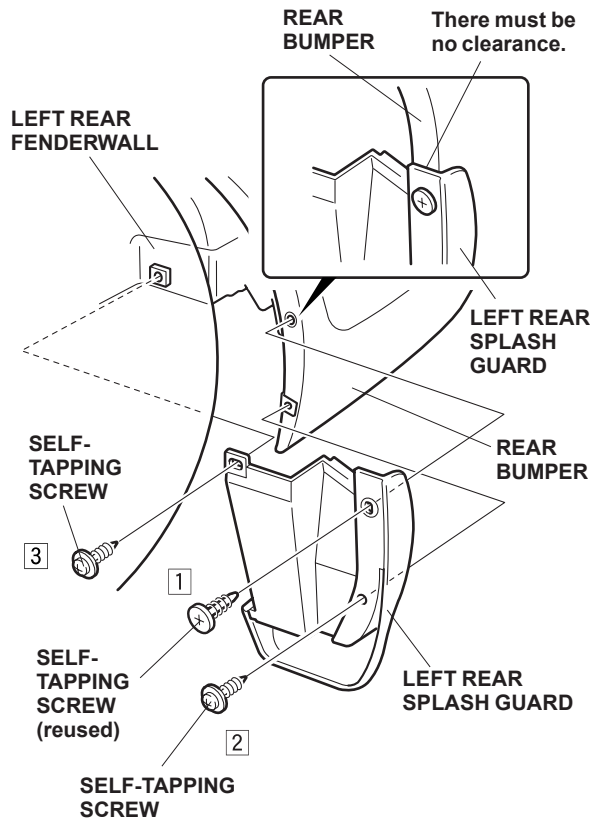

11. Hold the left rear splash guard against the fenderwall and check that there is no clearance between the splash guard and rear bumper. Tighten the three self-tapping screws in the sequence shown.
12. Repeat steps 7 thru 11 to install the right rear splash guard.