



INSTALLATION INSTRUCTIONS

Accessory
METER VISOR TRIM
 P/N 08Z03-TK6-100A

Application
2009 FIT

Publications No.
All 39869
 Issue Date
AUG 2008

PARTS LIST

Meter visor Trim

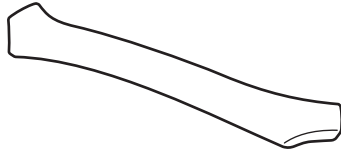

Alcohol swab

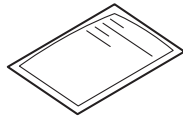

TOOLS AND SUPPLIES REQUIRED

Masking tape

INSTALLATION

NOTE: The meter visor trim should only be installed if the ambient air temperature is 15°C (60°F) or above.

Installing the Meter Visor Trim

1. Clean the area where the meter visor trim will attach using the alcohol swab.

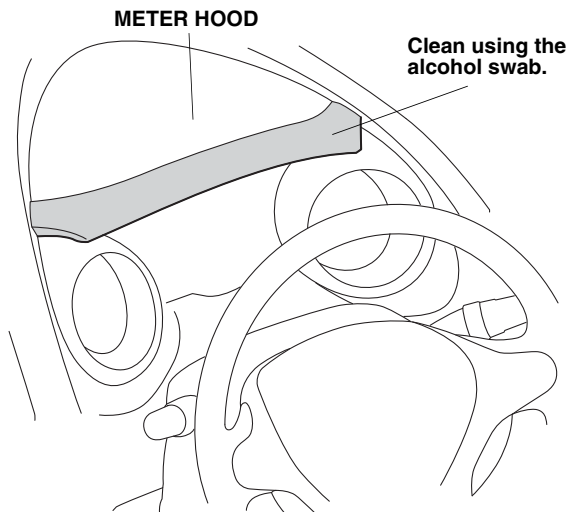

831703BR

2. Peel back approximately 1 1/2 inches of adhesive backing from each adhesive tape, and tape the ends to the front surface of the meter visor trim.

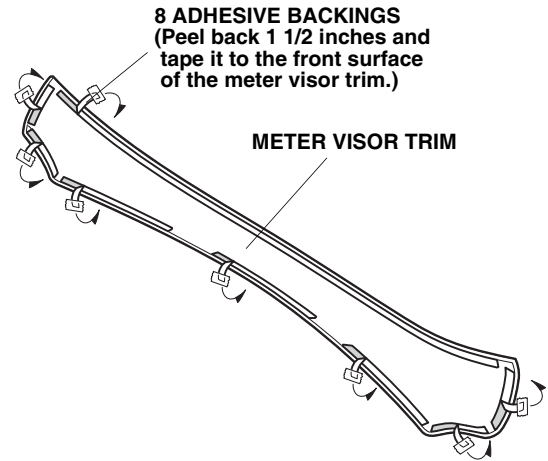

3. Attach the meter visor trim to the meter hood, and remove the eight adhesive backings. Press the entire meter visor trim firmly with the palm of your hand for 30 seconds, especially at the corners.

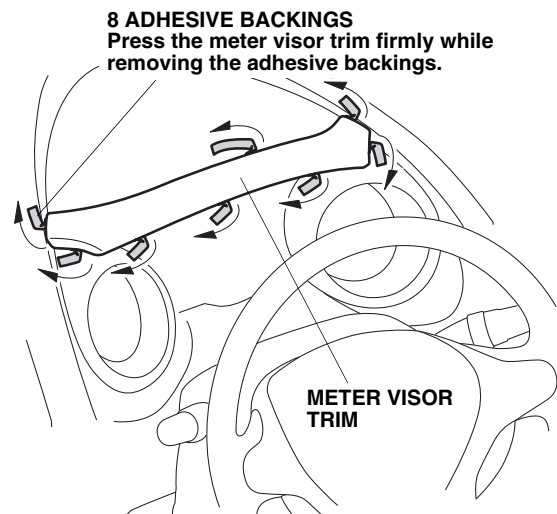

831704AR