



**INSTALLATION  
INSTRUCTIONS**

Accessory

**SPORT PEDALS**  
P/N 08U74-TK6-100A

Application

**2009 FIT**  
(A/T)

Publications No.

**All 39876**

Issue Date

**AUG 2008**

**PARTS LIST**

Accelerator pedal cover



Brake pedal pad



Brake pedal pad cover

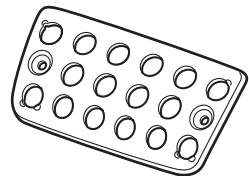

Upper plate



Lower plate

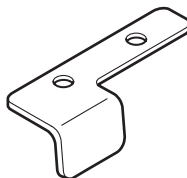

5 Rivets

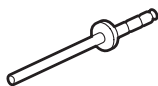

**TOOLS AND SUPPLIES REQUIRED**

Drill

2 mm and 5 mm Drill bits

Eye protection (safety goggles, face shield, etc.)

File

Felt-tip pen (white)

Pushpin

Rivet tool (MAR 3900)

Electrical tape

**INSTALLATION**

**Customer Information:** The information in this installation instruction is intended for use only by skilled technicians who have the proper tools, equipment, and training to correctly and safely add equipment to your vehicle. These procedures should not be attempted by "do-it-yourselfers."

## Installing the Accelerator Pedal Cover

1. Align the accelerator pedal cover with the accelerator pedal. Mark the accelerator pedal through the three holes in the accelerator pedal cover using a felt-tip pen (white).

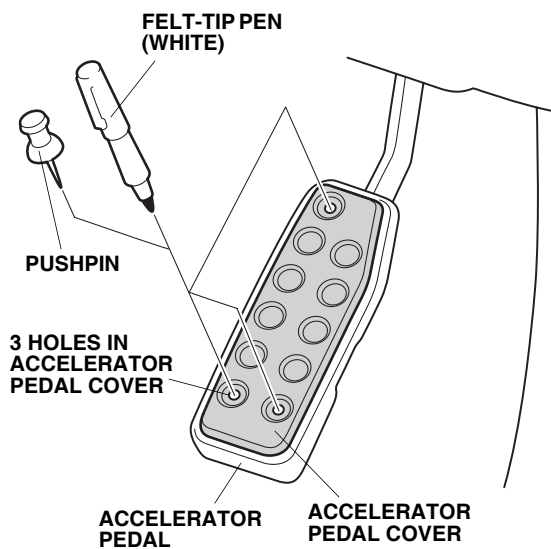

2. Remove the accelerator pedal cover. While wearing eye protection, drill the accelerator pedal at the pierced marks to 5 mm:

- Wrap each drill bit with electrical tape 7 mm from the tip.
- While holding the accelerator pedal to the floor, drill each pierced mark with a 2mm drill bit and finish with a 5 mm drill bit.
- Using a file, remove the burrs from the edge of the holes.

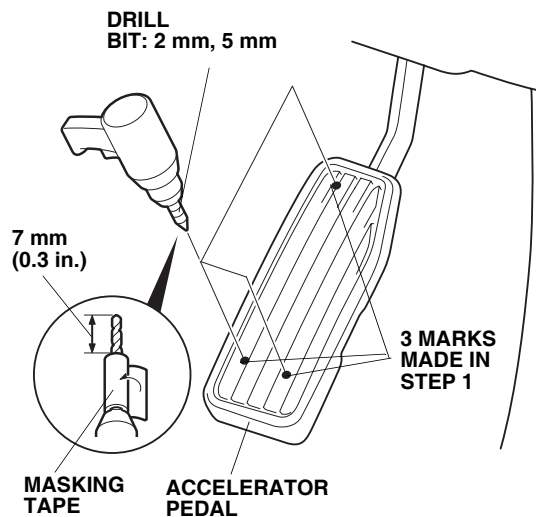

3. Slide the upper plate and lower plate into the left side of the accelerator pedal. Note the installation direction of the upper and lower plates.

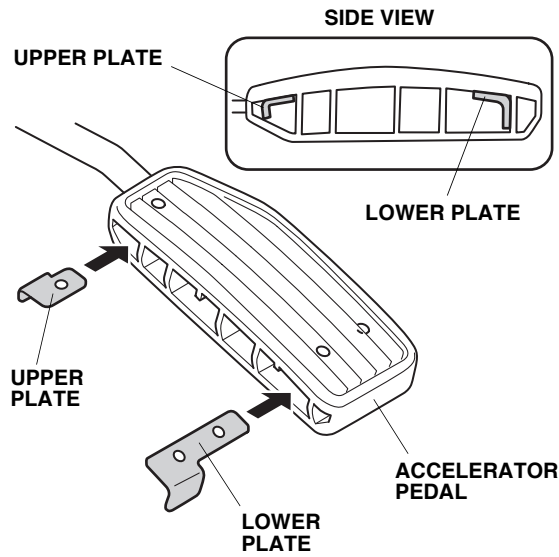

4. Place the accelerator pedal cover on the accelerator pedal, and insert one rivet through each hole in the pedal cover and into the plates. Using a rivet tool (MAR 3900), secure the accelerator plate to the accelerator pedal.

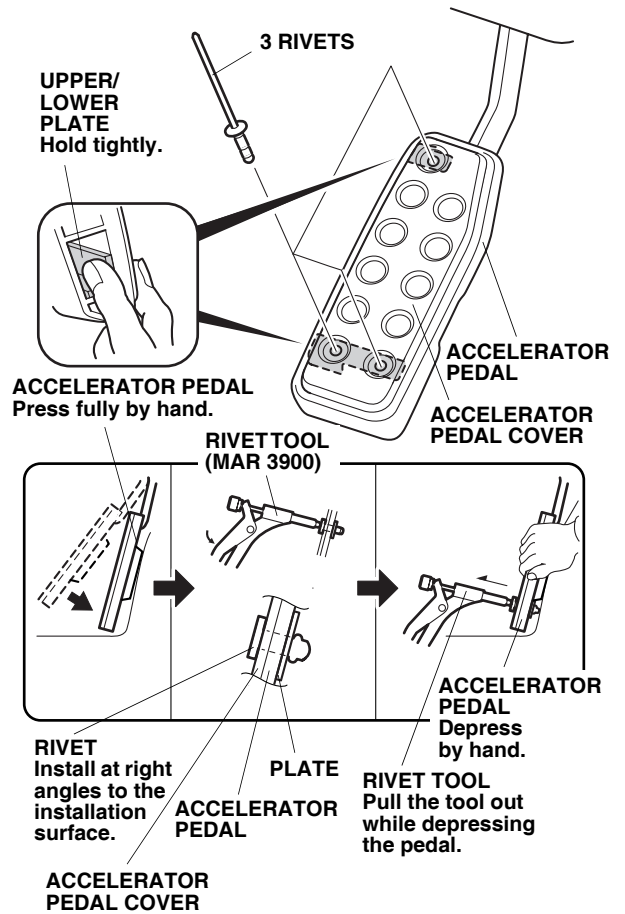

**Installing the Brake Pedal Pad Cover**

- Remove the vehicle brake pedal pad from the brake pedal.

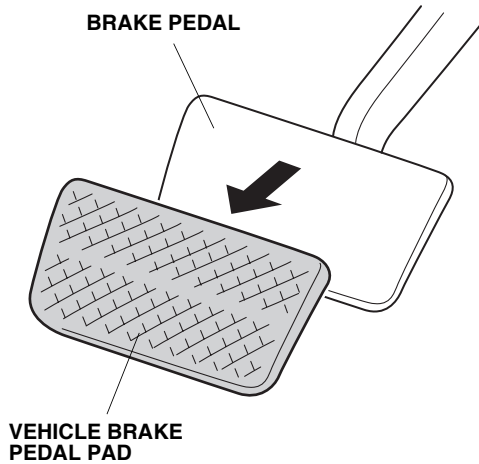

- Separate the rubber pedal from the brake pedal cover. Install the new brake pedal pad on the brake pedal. Check that the brake pedal pad is installed on the brake pedal securely.

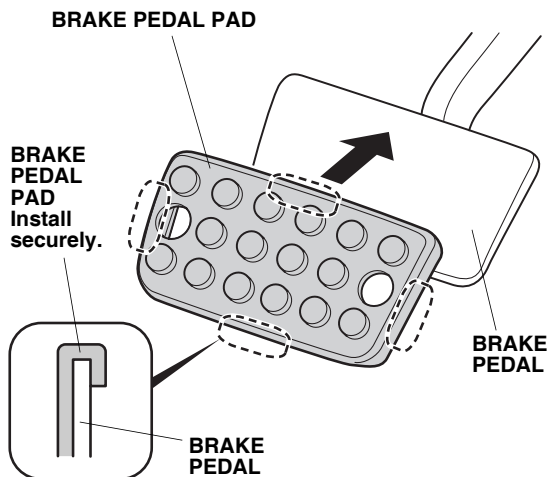

- Align the brake pedal pad cover over the brake pedal pad.

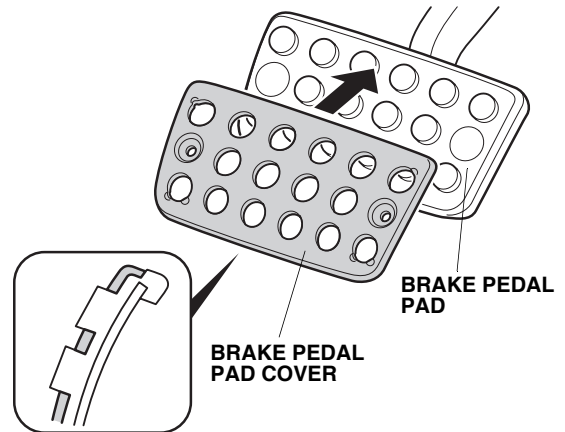

- Insert one rivet through each hole in the pedal pad/cover and into the brake pedal. Using the rivet tool, secure the brake pedal pad cover to the brake pedal.

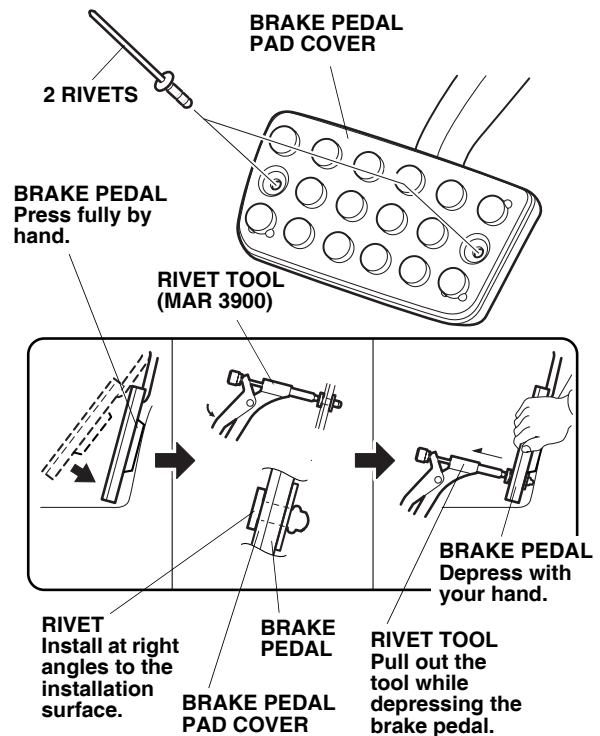

- Repeat steps 5 thru 9 to install the pedal pad and pedal pad cover to the clutch pedal.