



INSTALLATION INSTRUCTIONS

Accessory
FULL NOSE MASK
 FIT: P/N 08P35-SLN-100
 SPORT: P/N 08P35-SLN-100A

Application
2008 FIT

Publications No.
All 37456
 Issue Date
JULY 2007

Put this information in the glove box with the vehicle owner's manual.

PARTS LIST

Mask
(hood section)

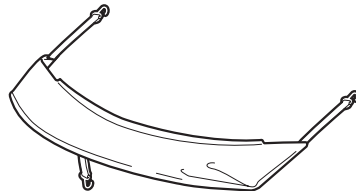

Mask
(bumper section)

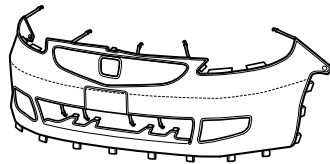

2 Snap-screws



2 Washers



2 Fenderwell nuts



Elastic cord

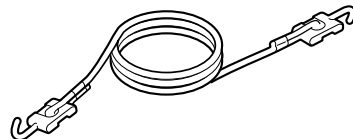

Storage bag

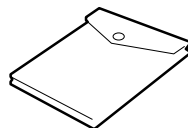

TOOLS AND SUPPLIES REQUIRED

Stubby Phillips screwdriver
 Flat-tip screwdriver

INSTALLATION

NOTE:

- Make sure the vehicle and the nose mask are clean and completely dry before installation. If moisture under the mask is allowed to dry, it may cloud the paint. If the mask gets wet, remove it and allow it to air-dry completely.
- Make sure any repainted surfaces are cured.
- Make sure the hood and nose of the vehicle have been waxed with a high-quality paste wax.
- Make sure to install the nose mask securely. If the nose mask starts to flap or comes loose while driving, safely pull off the highway, stop the vehicle, and secure or remove the mask.

Displaying the License Plate

If your state law requires the display of both license plates, cut out the piece of the bumper section that covers the front license plate:

- Face the inside of the mask toward you.
- Carefully remove the red overcast stitching from the backside of the license plate opening and remove the license plate section.

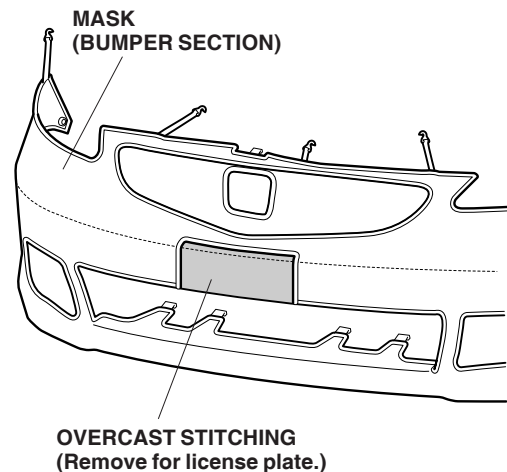

Installing the Hood Section

1. Open the hood. Fit the corners of the mask around the hood. Adjust the mask so that it fits smoothly over the edges. Attach the "S" hooks to the hood.

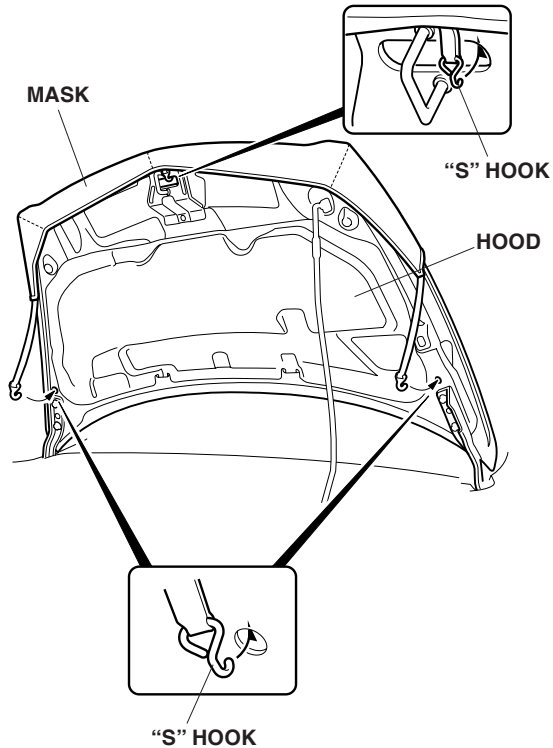

Installing the Fender Section

2. Turn the steering wheel all the way clockwise.
3. Pry out the expansion clip that fastens the inner fender; remove and retain the expansion clip, then clean the area around the hole.

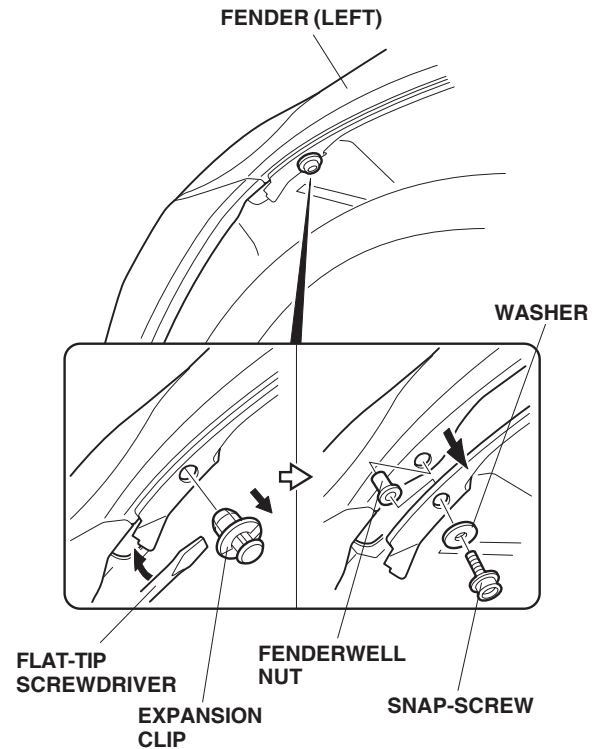

4. Pull the inner fender away, and press one fenderwell nut into the hole in the inner fender. Return the inner fenderwell to its original position.
5. With a snap-screw, secure a fenderwell nut and washer as shown.
6. Turn the steering wheel all the way counterclockwise and repeat steps 3 through 5 on the other side of the vehicle.

