



INSTALLATION INSTRUCTIONS

| | | |
|--------------------------------------|-----------------|------------------|
| Accessory | Application | Publications No. |
| ALL SEASONS/CARPET FLOOR MATS | 2007 FIT | All 31708 |
| | | Issue Date |
| | | MAR 2006 |

PARTS LIST

Floor Mats

Left front floor mat

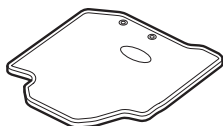

Right front floor mat

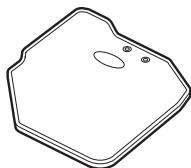

Right rear floor mat

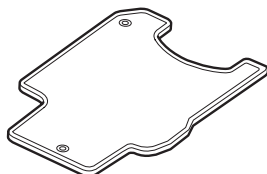

Left rear floor mat

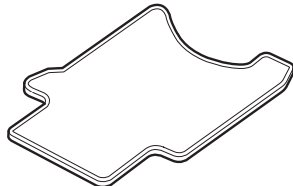

Template

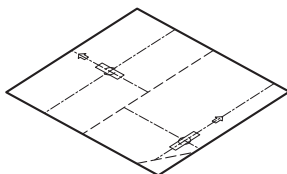

4 Front holders

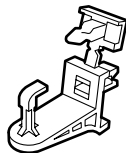

2 Rear hook holders



2 Rear base holders



TOOL REQUIRED

- Utility knife
- Masking tape

INSTALLATION

NOTE: Before installation, confirm the installation locations of the floor carpet mats.

Installing the Front Holders

- Slide the driver's seat completely to the rear.

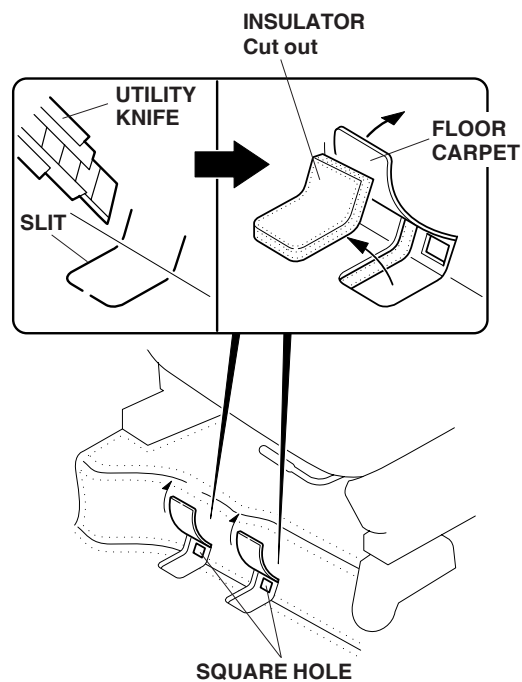

- Make cuts with a utility knife at the slits in the floor carpet at the two locations shown.
- Cut out the insulator matching the previously cut hole.

