



**INSTALLATION
INSTRUCTIONS**

Accessory REAR BUMPER APPLIQUE P/N 08P48-SNA-100	Application 2009 CIVIC 4-DOOR	Publications No. All40164-40750
		Issue Date OCT 2008

PARTS LIST

Rear bumper applique

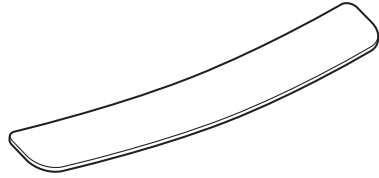

Applicator

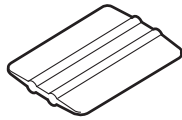

Soft sleeve

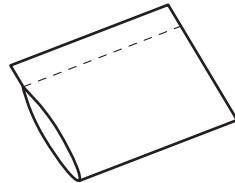

Alcohol swab

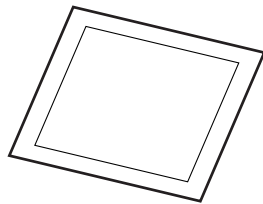

TOOLS AND SUPPLIES REQUIRED

- Masking tape
- Felt-tip pen
- Ruler

INSTALLATION

NOTE:

- Be careful not to damage the rear bumper and other finished surfaces of the body.
 - The rear bumper applique should be installed only if the ambient air temperature is 15°C (60°F) or above. Heat the rear bumper applique and bonding surfaces with a hair dryer set on LOW if the ambient air temperatures is below.
 - Do not wash the vehicle for 24 hours to cure the adhesive.
1. Using the alcohol swab, clean the rear bumper where the rear bumper applique will attach.

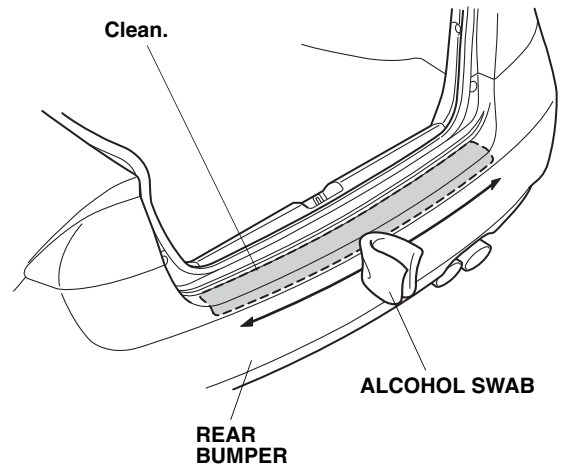

2. Attach masking tape to the rear bumper applique, then mark on the masking tape as shown.

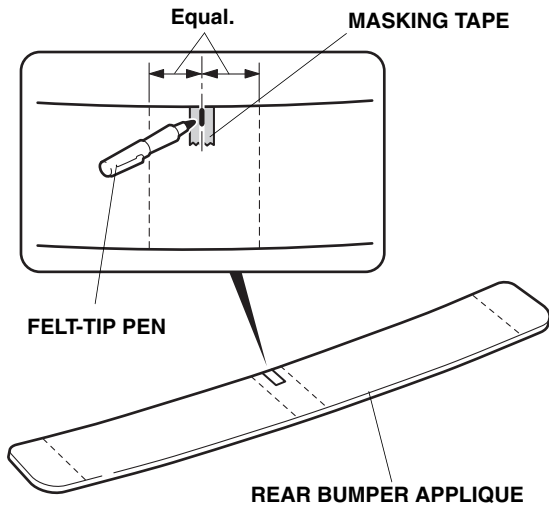

3. Place the rear bumper applique on the rear bumper, then attach masking tapes to the rear bumper as shown.

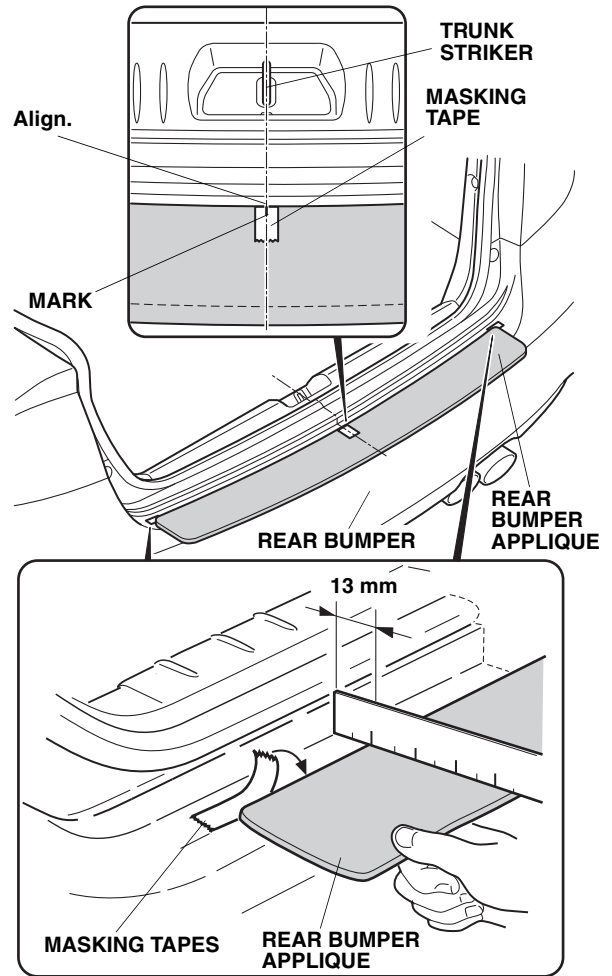

- Remove the center backing from the rear bumper applique.

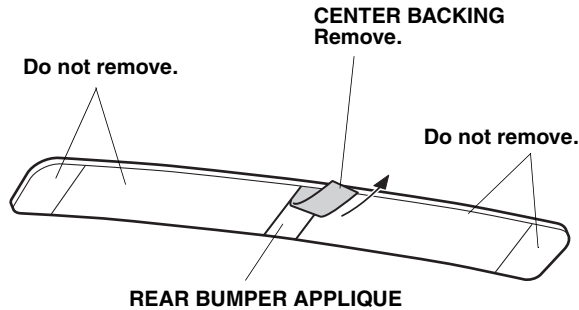

- Place the rear bumper applique on the rear bumper as shown.

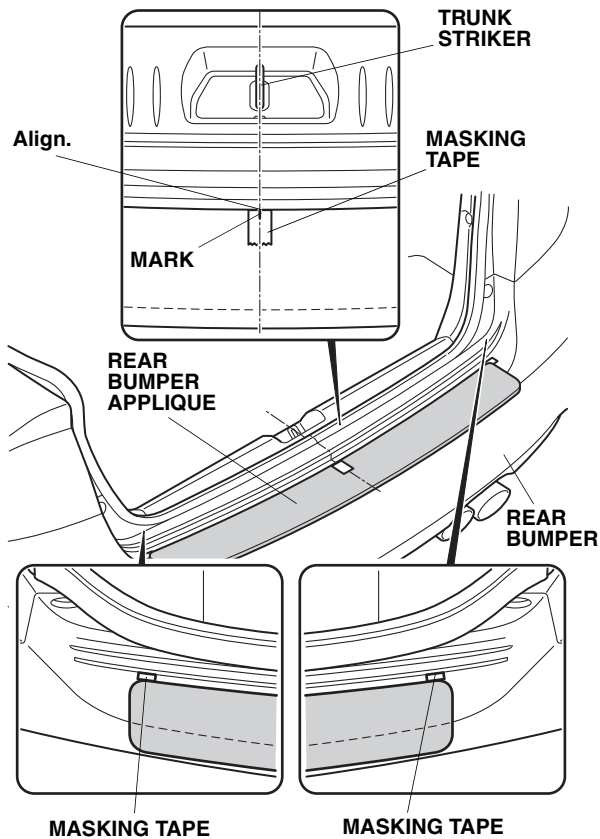

- Remove the backing shown. Using the applicator with the soft sleeve, apply pressure to smooth out the top surface the rear bumper applique. If you see any air bubbles, gently peel up that section and work out the air bubbles.

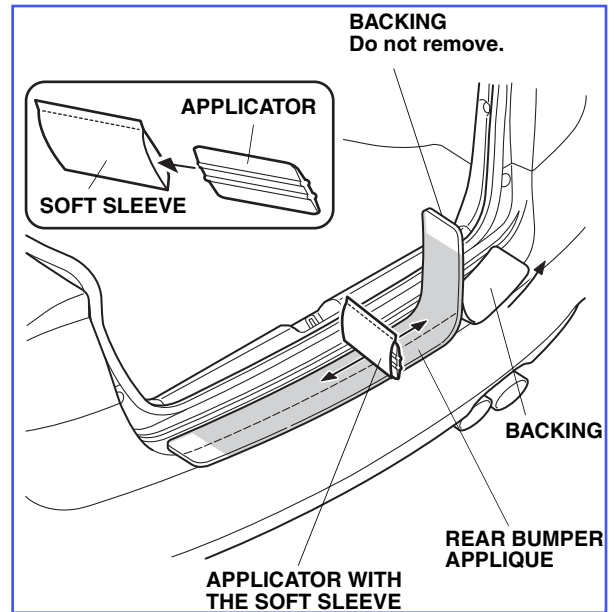

- Work the same way on the other side.
- Remove the backing shown. Using the applicator with the soft sleeve, apply pressure to smooth out the top surface the rear bumper applique. If you see any air bubbles, gently peel up that section and work out the air bubbles.

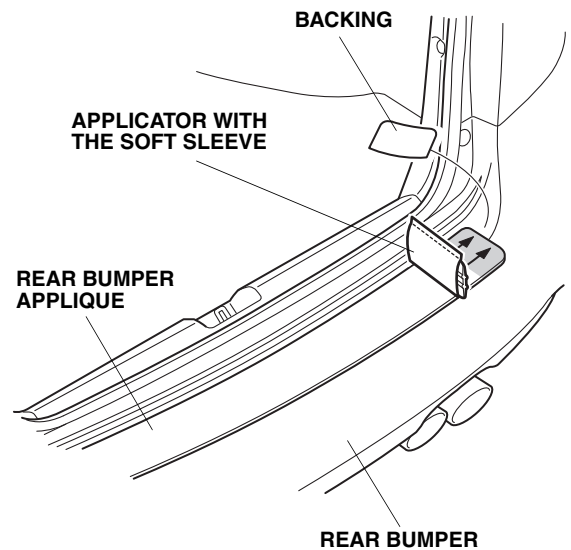

- Work the same way on the other side.

10. Starting from the middle and working outward, use the applicator with the soft sleeve to apply the rear bumper applique to the rounded rear edge as shown.

