



**INSTALLATION
INSTRUCTIONS**

Accessory
TRUNK SPOILER (WING)

Application
**2010 ACCORD
4-DOOR**

Publications No.
All 42275
Issue Date
AUG 2009

PARTS LIST

Trunk spoiler

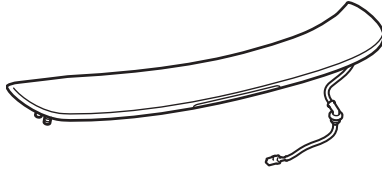

Left trunk spring (marked yellow)

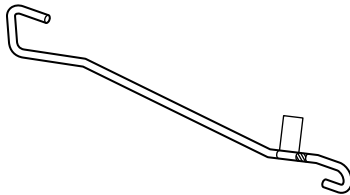

Right trunk spring (marked red)

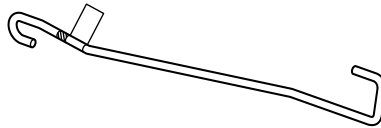

Template

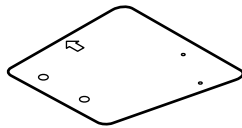

4 Spoiler nuts, 6 mm



Spoiler harness

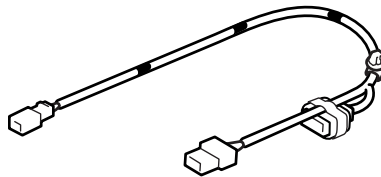

7 Wire ties

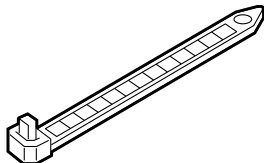

2 Rubber stops

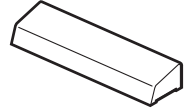

5 Wire ties with clip A

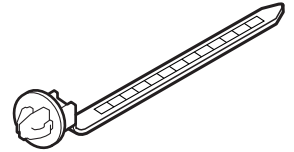

2 Bolts, 6 x 12 mm

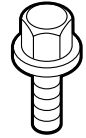

Connector clip

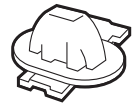

Wire tie with clip B

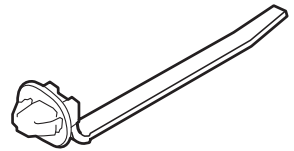

TOOLS AND SUPPLIES REQUIRED

Shop towel
Small flat-tip screwdriver
Eye protection (face shield, safety goggles, etc.)
Drill
3 mm, 8 mm, and 10 mm Drill bits
Drill stop
Felt-tip pen
Center-punch
File
Touch-up paint
Tape
Socket
Torque wrench
Heavy gloves
Clip remover
Trunk Spring Tool
T/N 07XAZ-S0K-0100 or 07AAF-SNA-A100
Isopropyl alcohol
Silicone spray

INSTALLATION

Customer Information: The information in this installation instruction is intended for use only by skilled technicians who have the proper tools, equipment, and training to correctly and safely add equipment to your vehicle. These procedures should not be attempted by "do-it-yourselfers."

NOTE:

- Be careful not to damage the body paint finish.
 - This trunk spoiler kit should be installed only if the ambient air temperature is 15°C (60°F) or above.
 - Wash and wax the area to be covered with a high-quality paste wax.
1. Make sure you have the anti-theft codes for the audio system and the navigation system (if equipped). Then write down the radio presets.
 2. Disconnect the negative cable from the battery.

3. Open the trunk lid. Remove the trunk lid trim panel (if equipped) (12 clips).

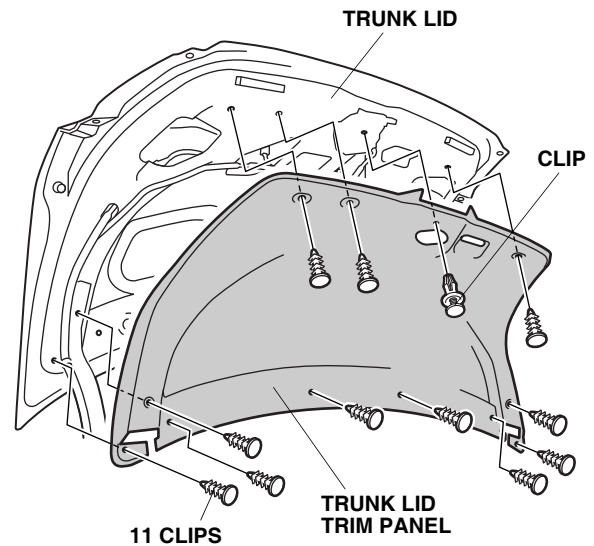

4. On the inside of the trunk lid, locate the two identification marks on the trunk lid. Lightly center-punch each mark. Repeat on the right side of the trunk lid.

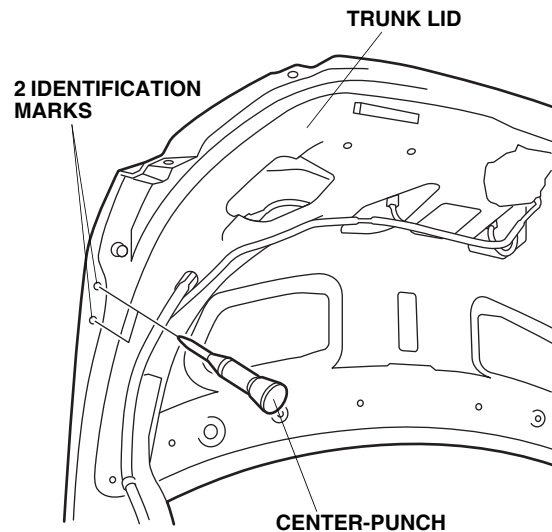

5. While wearing eye protection, first drill with a 3 mm drill bit, and finish with an 8 mm drill bit.
- To prevent metal shavings from falling onto the trunk floor, place a cover over the trunk floor.
 - Remove all burrs and metal shavings, and apply touch-up paint to the edges of the holes you drilled.
 - Repeat on the right side of the trunk lid.

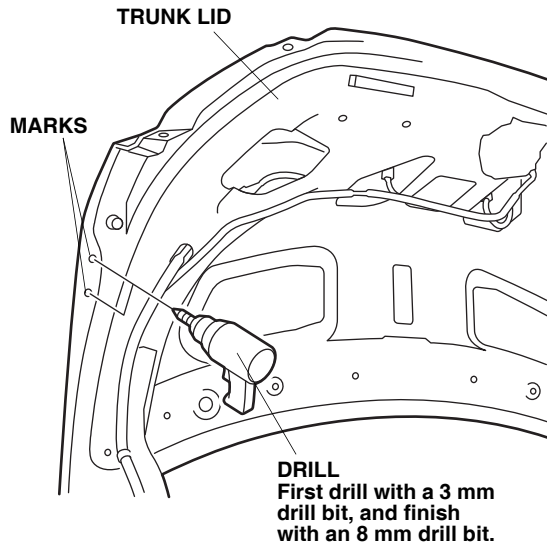

6. Attach tape to both sides of the trunk lid in the areas shown.

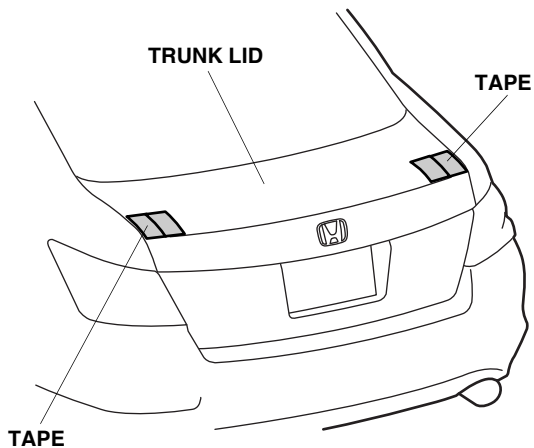

7. Close the trunk lid. Align the template with the edge of the trunk lid on the left side. Using a felt-tip pen, mark the trunk lid as shown on the template. Remove the template.

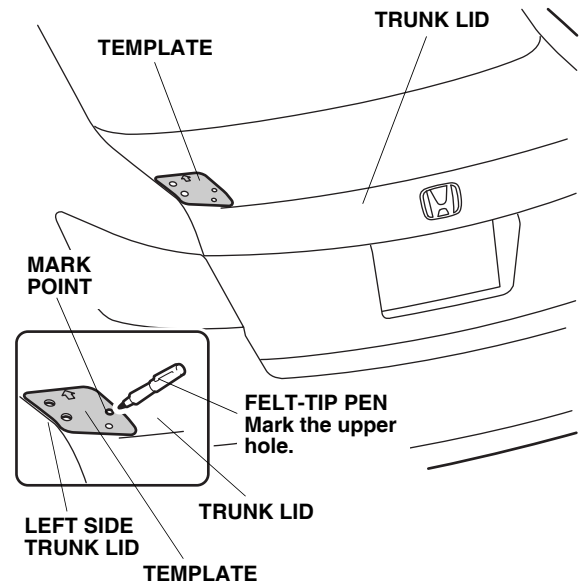

8. Flip the template over, and align it with the edge of the trunk lid on the right side. Using a felt-tip pen, make two marks on the right side trunk lid as shown on the template. Remove the template.

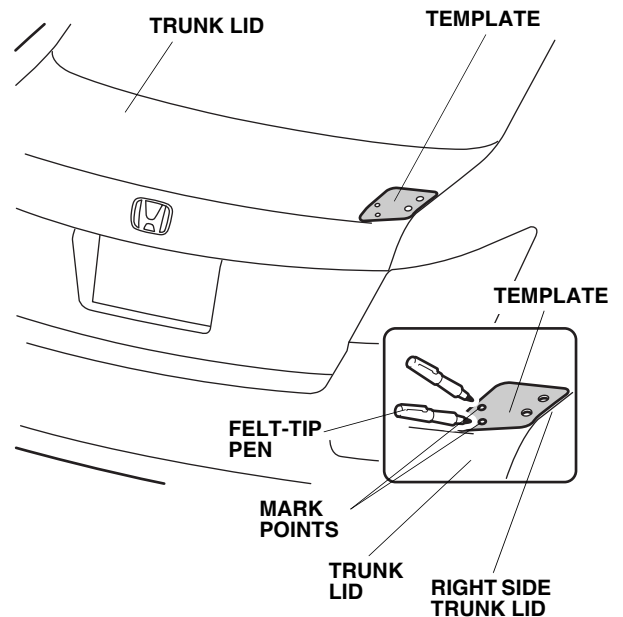

9. Center-punch the mark on the left side of the trunk lid. While wearing eye protection, first drill with a 3 mm drill bit, and finish with an 8 mm drill bit. Remove the tape.
- To prevent drilling through the trunk lid, wrap the drill bit with tape 10 mm away from the tip.
 - Remove all burrs and metal shavings, and apply touch-up paint to the edge of the hole you drilled.
 - Take care not to damage the wire harnesses when drilling the holes.

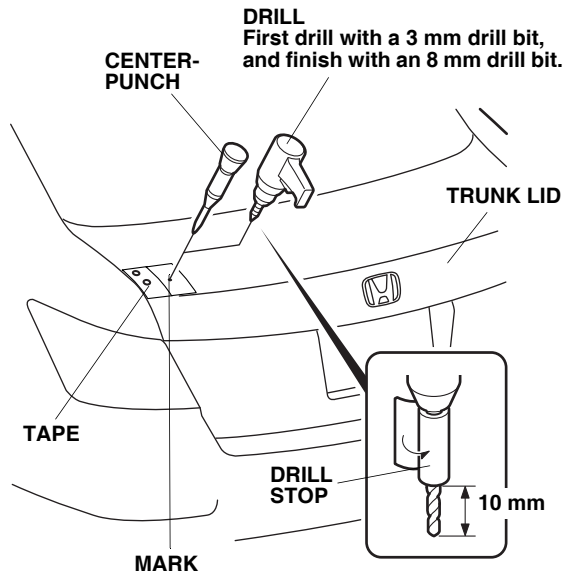

10. Center-punch the two marks on the right side of the trunk lid.

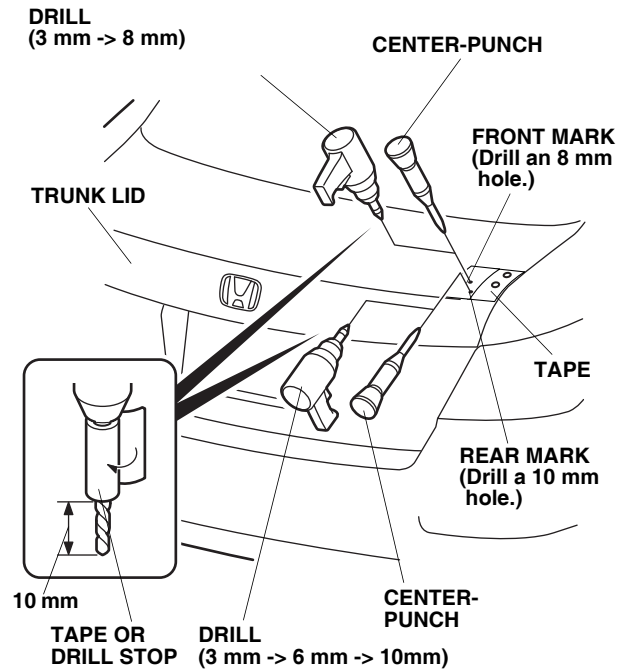

11. While wearing eye protection, drill the trunk lid at each center-punched mark.
- Take care not to damage the wire harness when drilling.
 - Wrap each drill bit with electrical tape 10 mm from the tip, or use a drill stop.
 - Drill both center-punched marks to 8 mm. First drill with a 3 mm drill bit, then with a 6 mm drill, and finish with an 8 mm drill bit.
 - Enlarge the bottom hole in the trunk lid to 10 mm using a 10 mm drill bit.
 - Remove any burrs and metal shavings, and apply touch-up paint to the edges of each drilled hole. Allow the touch-up paint to dry before proceeding to the next step.

- Hold the trunk spoiler above the trunk lid, and route the trunk spoiler harness down through the 10 mm hole. Seat the grommet into the 10 mm hole; then route the trunk spoiler harness through the rectangular hole. If necessary, spray silicone spray on the grommet, and use a piece of wire to pull the harness through the trunk lid.

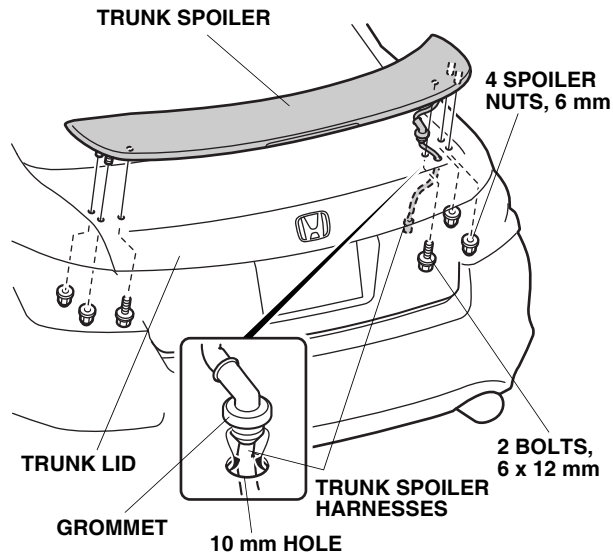

- Fit the trunk spoiler into position on the trunk lid, and install the four 6 mm spoiler nuts and two 6 x 12 mm bolts. Hold the trunk spoiler firmly against the trunk lid and torque the spoiler nuts and bolts to 9 N·m (6.5 lb-ft).

Installing the Trunk Springs

- Push in on the tab, and pull down the seat-back release lever to release the hook.

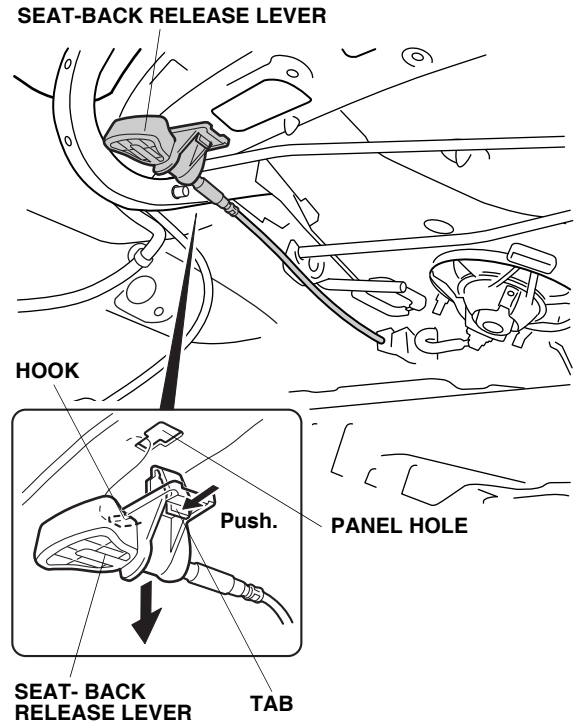

- Slide the seat-back release lever to the right side, and remove the release lever clip from the hole in the vehicle panel.
- Open the trunk lid, and remove the center clip from the trunk springs.

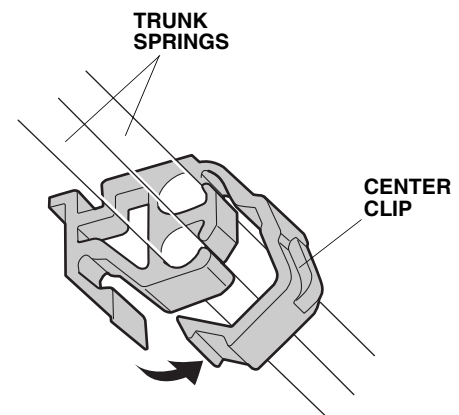

17. With an assistant holding the trunk lid open, remove the old trunk springs from the trunk hinge arms using the trunk spring tool. Wear gloves to protect your hands, and pull the trunk spring tool slowly and carefully towards you.

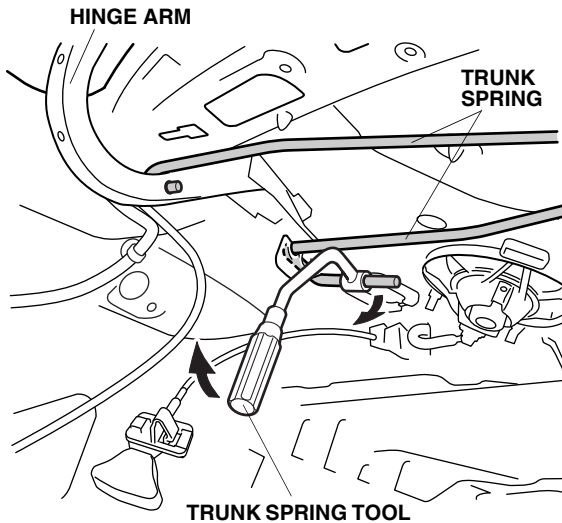

18. Install the right trunk spring and the left trunk spring in the reverse order of removal:

- Set the tool on the marked end of each trunk spring.
- Install the red marked spring in the slot in the right (passenger's) side trunk hinge arm and in the hinge bracket on the left (driver's) side of the vehicle; install the yellow marked spring in the slot in the left (driver's) side trunk hinge arm and in the hinge bracket on the right (passenger's) side of the vehicle.
- Wearing gloves, rotate the tool as you pull it towards you.
- Set the springs in the first notch (original position) of the hinge brackets.

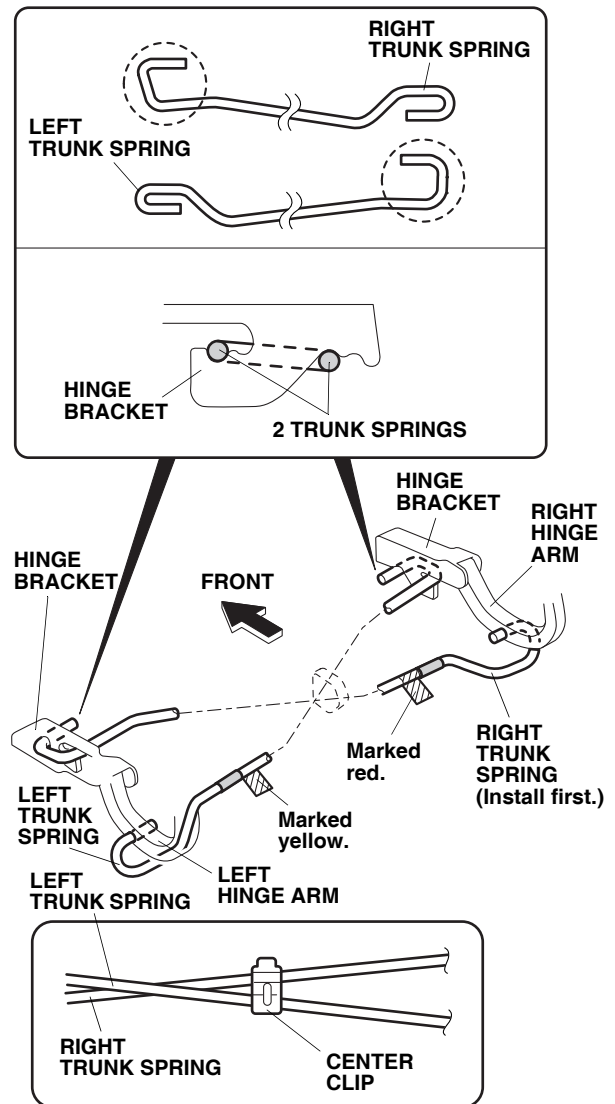

Routing the Spoiler Harness

19. Remove the trunk floor mat (one clip).

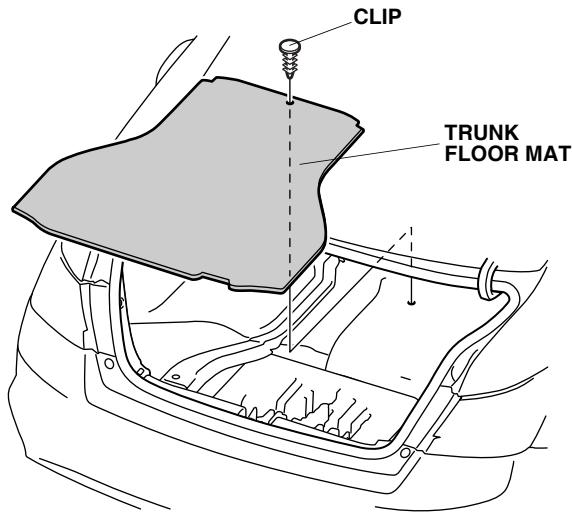

20. Remove the tool box.

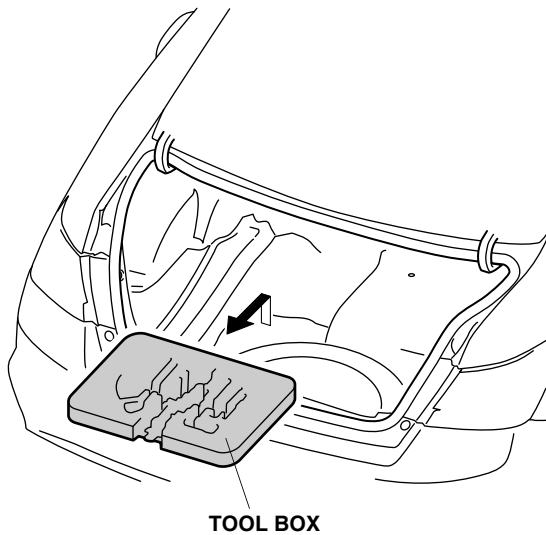

21. Remove the trunk rear trim panel (four clips and three hooks).

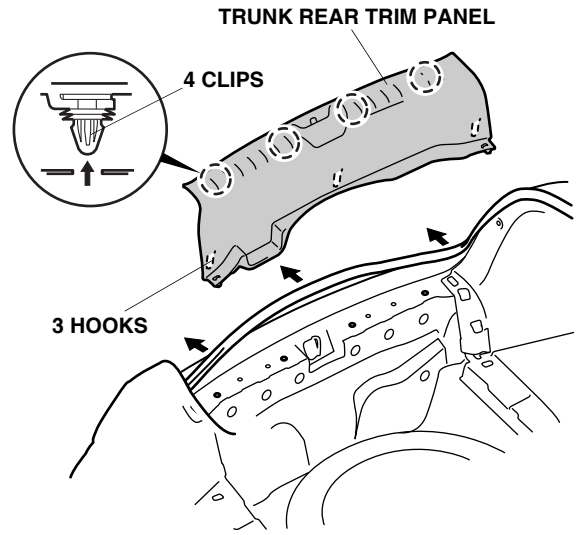

22. Reinstall the seat-back release lever.

23. Inside the trunk, fold the rear seat-back by pulling the lever under the rear shelf.

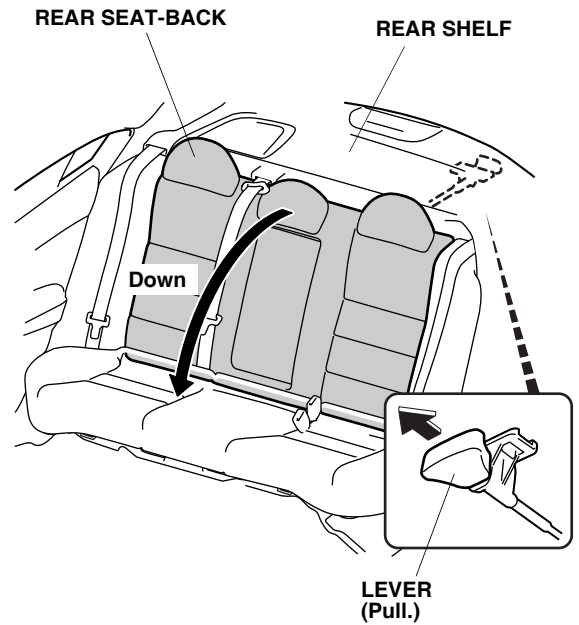

24. Remove the right trunk side trim panel (five clips).

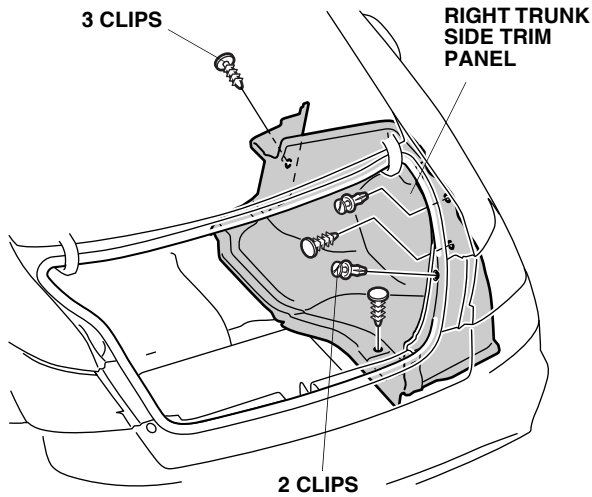

25. Route the trunk spoiler harness from the trunk lid hole as shown, and plug the trunk spoiler 2-pin connector into the trunk spoiler harness 2-pin connector.

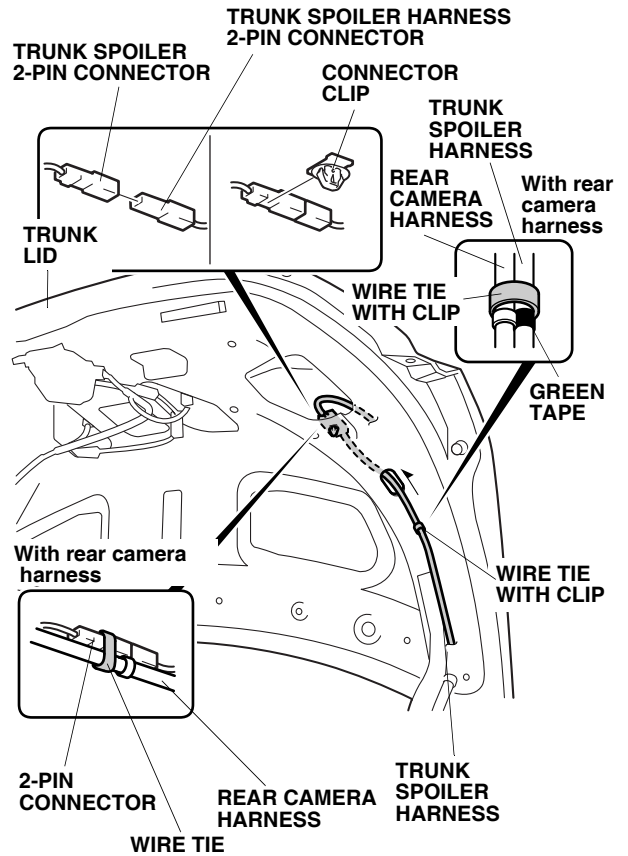

26. Install the connector clip to the 2-pin connector, and secure the 2-pin connector to the vehicle panel.
 NOTE: If a rear camera harness is installed, do not install the connector clip. Secure the spoiler harness to the rear camera harness with one wire tie.
27. Secure the trunk spoiler harness with one wire tie with clip to the trunk lid.
 NOTE: If a rear camera harness is installed, cut off the clip from the wire tie with clip, and secure the spoiler harness to the rear camera harness as shown.

28. Route the trunk spoiler harness along the trunk lid hinge, and secure it with four wire ties with clip A to the holes in the hinge. Align the last clip with the green tape.

NOTE: If a rear camera harness is installed, cut off the clips from the wire ties with clip A, and secure the spoiler harness to the rear camera harness as shown.

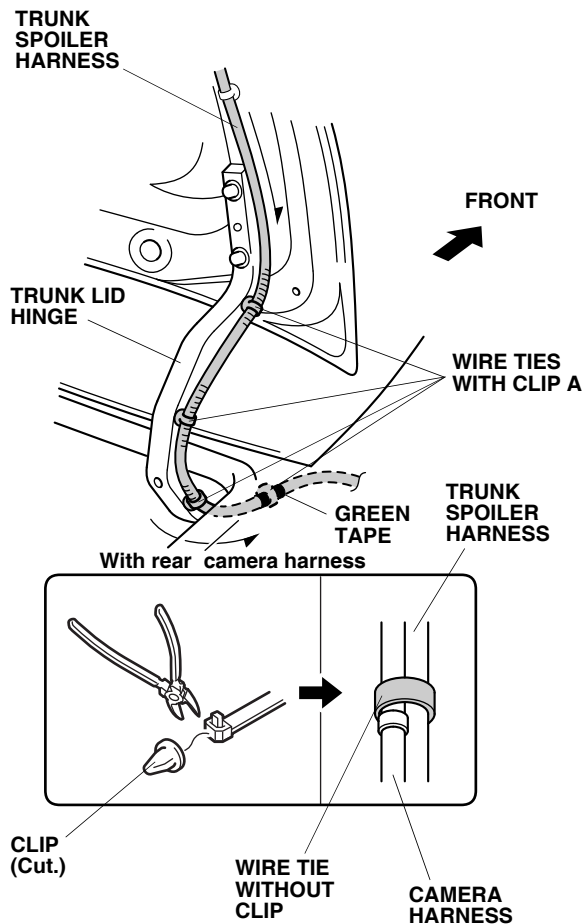

29. Route the trunk spoiler harness, and secure it to the vehicle panel holes with two wire ties with clip.

NOTE: If a rear camera harness is installed, cut off the wire tie, and the wire ties with clip, and secure the spoiler harness to the rear camera harness as shown.

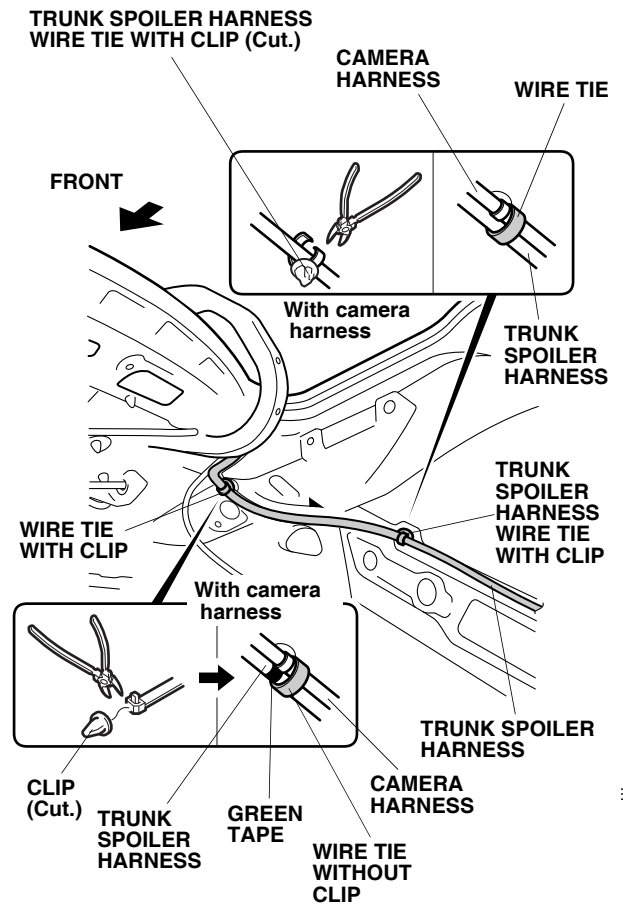

30. Disconnect the 4-pin connector from the right side brake light.

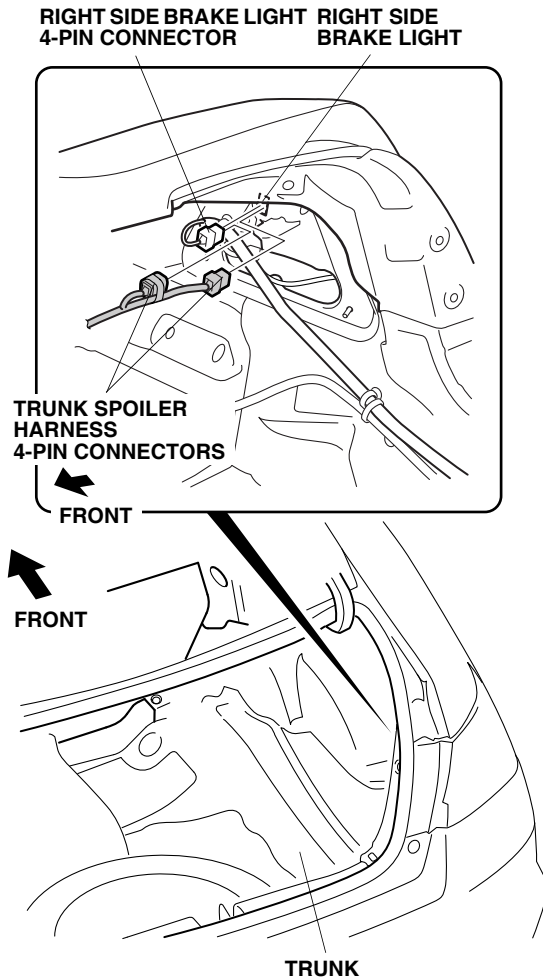

31. Plug the trunk spoiler harness 4-pin connector into the right side brake light. Plug the vehicle harness 4-pin connector into the trunk spoiler harness 4-pin connector.

32. Secure the trunk spoiler harness to the vehicle harness with one wire tie as shown.

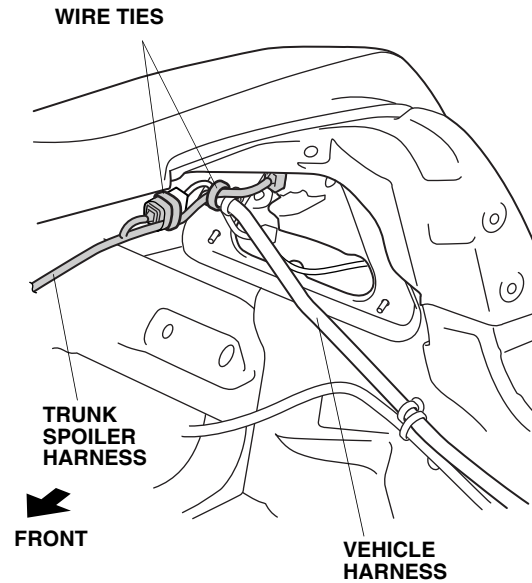

33. Secure the trunk spoiler harness 4-pin connector with one wire tie as shown.
34. Disconnect the vehicle 2-pin connector from the high-mount brake light.

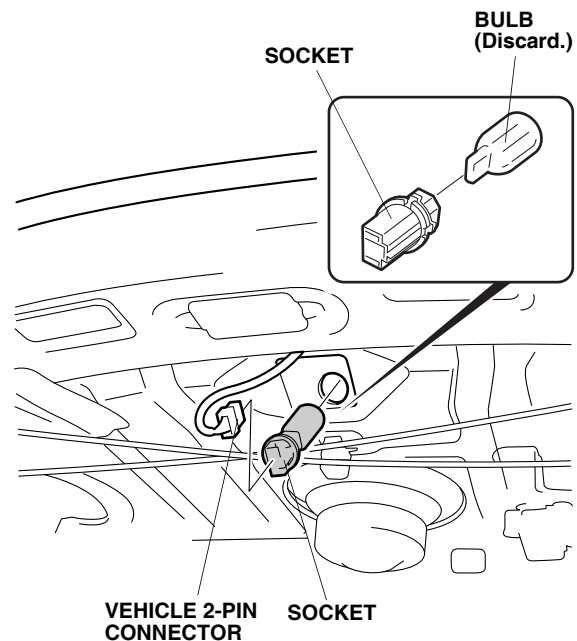

35. Remove the socket from the high-mount brake light by turning it counterclockwise, then remove the bulb from the socket.
36. Reinstall the socket to the high-mount brake light, and connect the vehicle 2-pin connector to the high-mount brake light.

37. Using isopropyl alcohol on a shop towel, clean the areas where the rubber stoppers will attach.

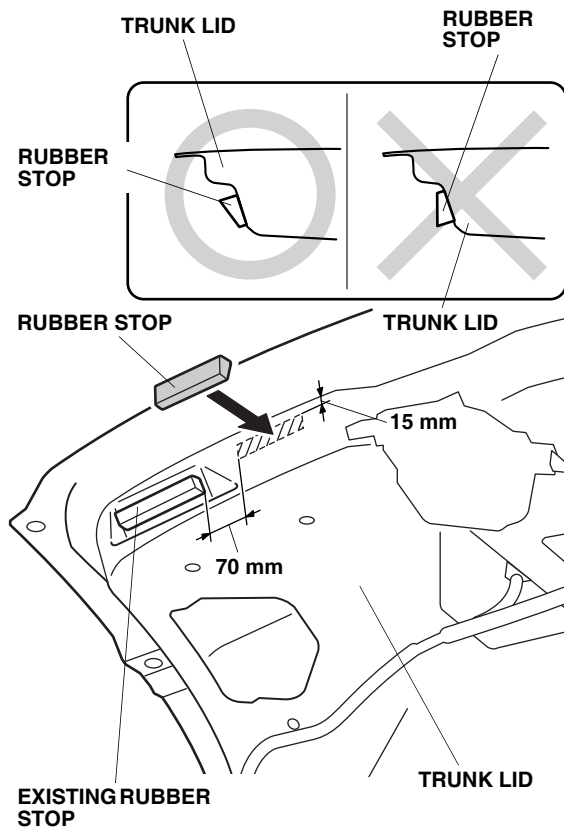

38. Remove the adhesive backing from one rubber stop, and attach it to the inside panel of the trunk lid as shown. After attaching it, use the palm of your hand to hold pressure against it for 30 seconds. Repeat on the right side.
39. Reinstall the trunk lid lining.
40. Open the trunk lid, and make sure the trunk lid stays open on its own. If it won't, adjust the trunk springs to the second position.
41. Check that all wire harnesses are routed properly and all connectors are plugged in.
42. Reconnect the negative cable to the battery.
43. Press the brake pedal, and check that the spoiler brake light comes on.
44. Reinstall all removed parts.
45. Enter the customer's audio and navigation (if equipped) anti-theft codes.
46. Reset the clock (on vehicles without navigation).