



**INSTALLATION
INSTRUCTIONS**

Accessory
DOOR VISORS
P/N 08R04-TA0-100

Application
2008 ACCORD
4-DOOR

Publications No.
All 35374-40089

Issue Date
JULY 2008

PARTS LIST

Left front door visor

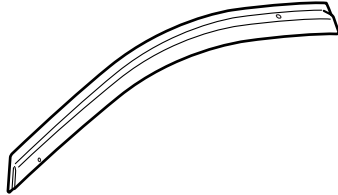

Right front door visor

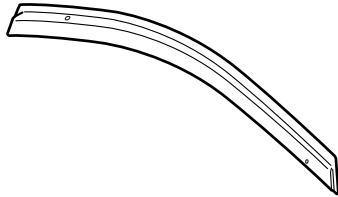

Left rear door visor



Right rear door visor



4 Brackets B

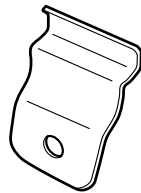

4 Brackets C



8 Clips



TOOLS AND SUPPLIES REQUIRED

Isopropyl alcohol

Soft towel

Ruler

Illustration of the Door Visors Installed on the Vehicle

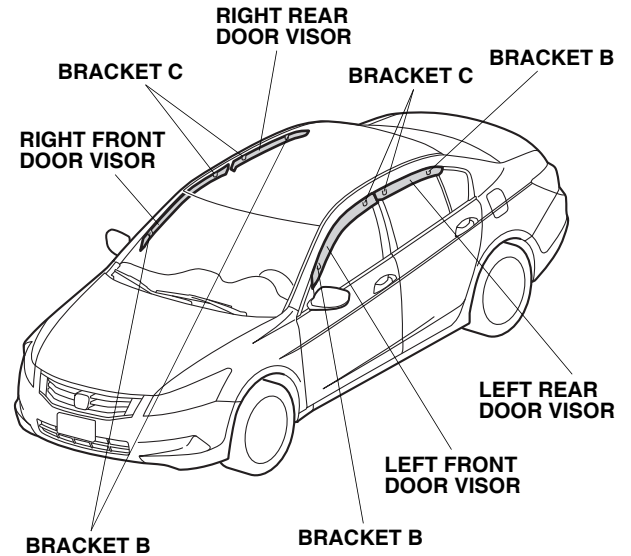

INSTALLATION

Customer Information: The information in this installation instruction is intended for use only by skilled technicians who have the proper tools, equipment, and training to correctly and safely add equipment to your vehicle. These procedures should not be attempted by “do-it-yourselfers.”

NOTE:

- Visors may not be legal in all states. Please check the laws of your state.
- These instructions show the left door visors being installed. The same procedure applies to installing the right door visors.
- Be careful not to damage the paint finish and glass run channels when installing the door visors.
- Handle the door visors with care. They are not designed to absorb shock or impact.
- This door visor kit should only be installed if the ambient air temperature is 15°C (60°F) or above.
- To allow the adhesive to cure, do not wash the vehicle for 24 hours.

1. Fully open the driver's window.

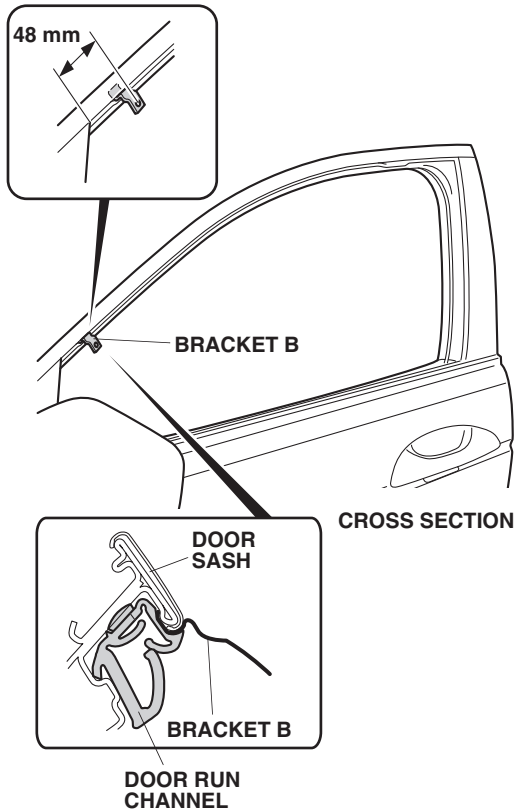

2. Install bracket B to the door sash at the measurement shown. Verify the shape at the identification mark stamped on the bracket. Be sure the door run channel is installed properly before installing the bracket.

3. Install bracket C on the door sash at the measurement shown. Verify the shape and the identification mark stamped on the bracket. Be sure the door run channel is installed properly before installing the bracket.

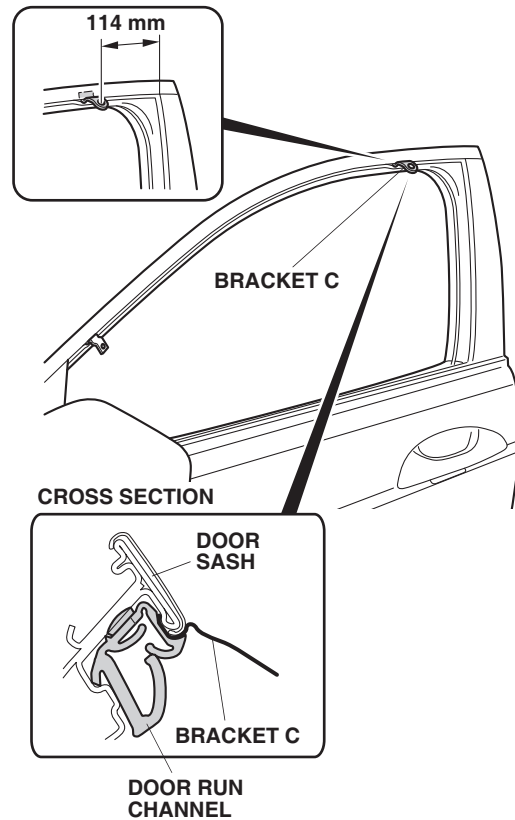

4. Peel back approximately 1-1/2 to 2 inches of adhesive backing from each adhesive tape, and tape the ends to the front surface of the left front door visor.

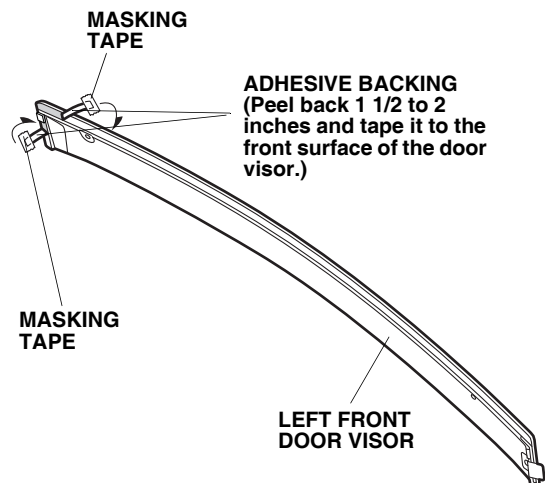

5. Using isopropyl alcohol on a shop towel, clean the door sash where the left front door visor will attach.

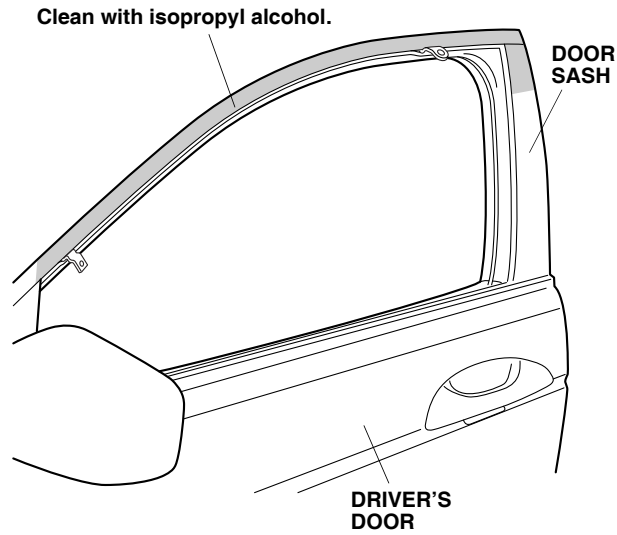

6. Position the door visor on the door sash.

7. Adjust the position of bracket B to install the door visor, then install a clip. Push up on bracket B so the tip of the door run channel fits tightly to the bracket. There should be no clearance between the bracket and the door sash.

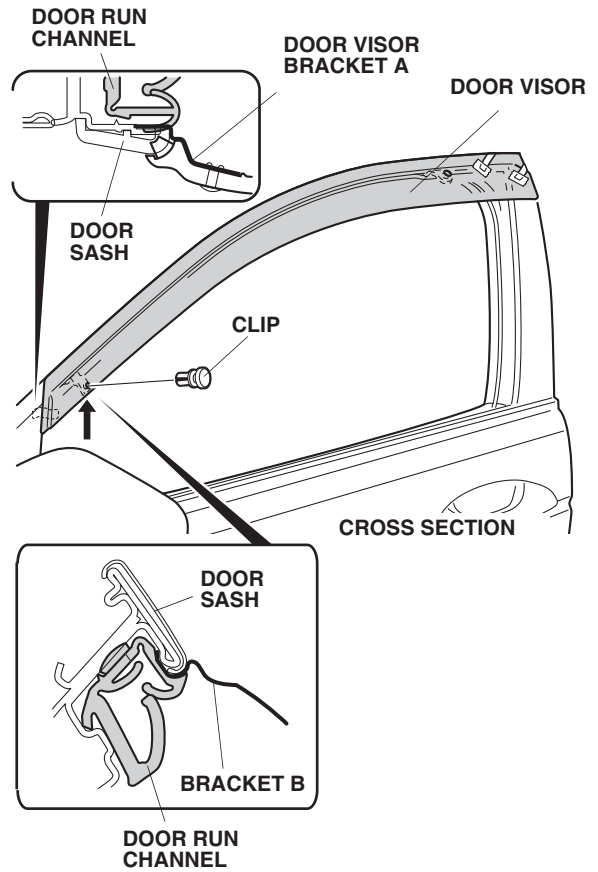

8. Adjust the position of bracket C to install the door visor, then install the clip. Push up on bracket C so the door run channel fit tightly to the bracket. There should be no clearance between the bracket and the door sash.

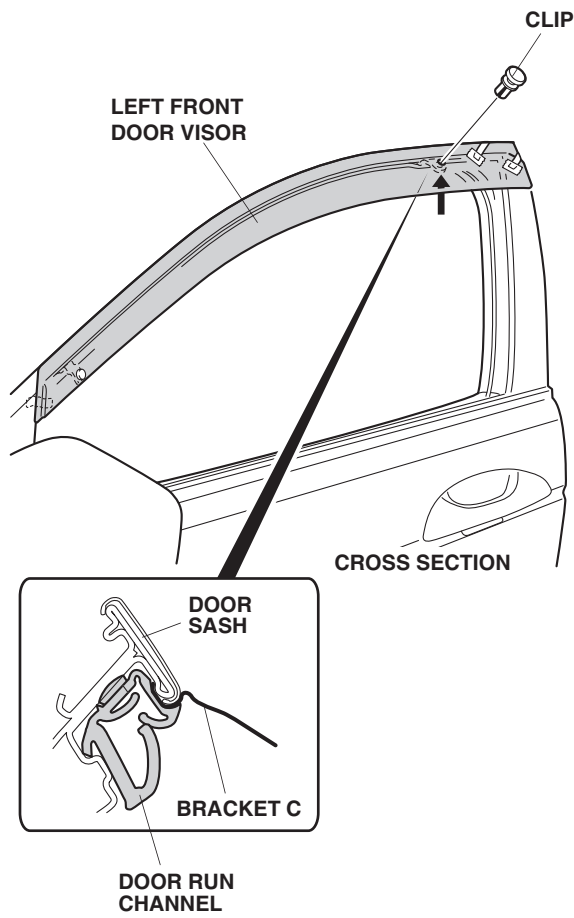

9. Measure the distance between the edge of the door visor and the outside edge of the door sash as shown.

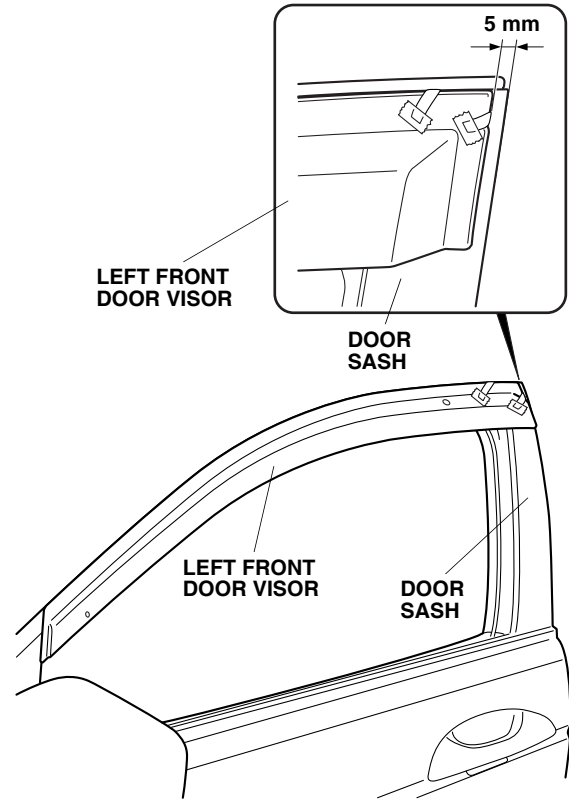

10. Fully open the left rear door glass.

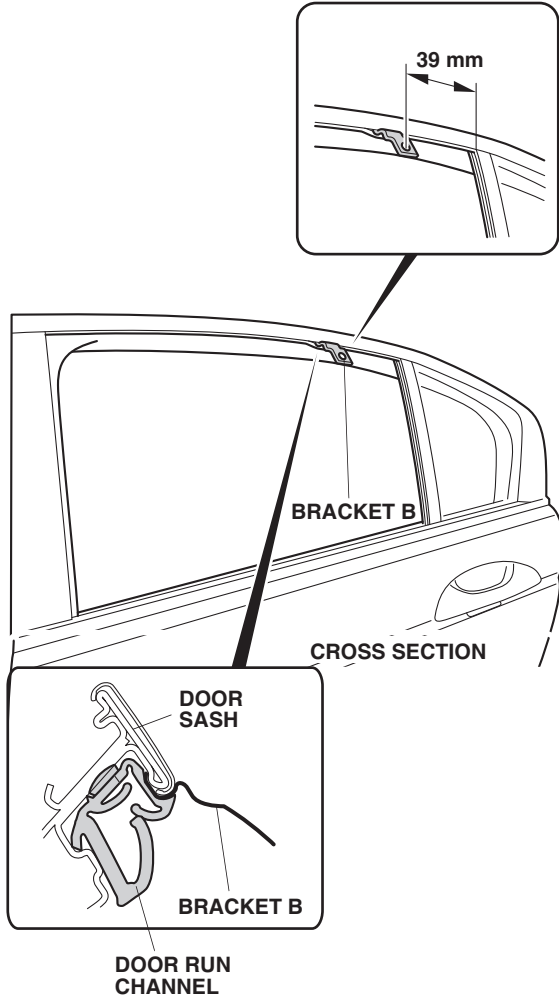

11. Install bracket B to the door sash at the measurement shown. Verify the shape and the identification mark stamped on the bracket. Be sure the door run channel is installed properly before installing the bracket.

12. Install the bracket C to the door sash at the measurement shown. Verify the shape and the identification mark stamped on the bracket. Be sure the door run channel is installed properly before installing the bracket.

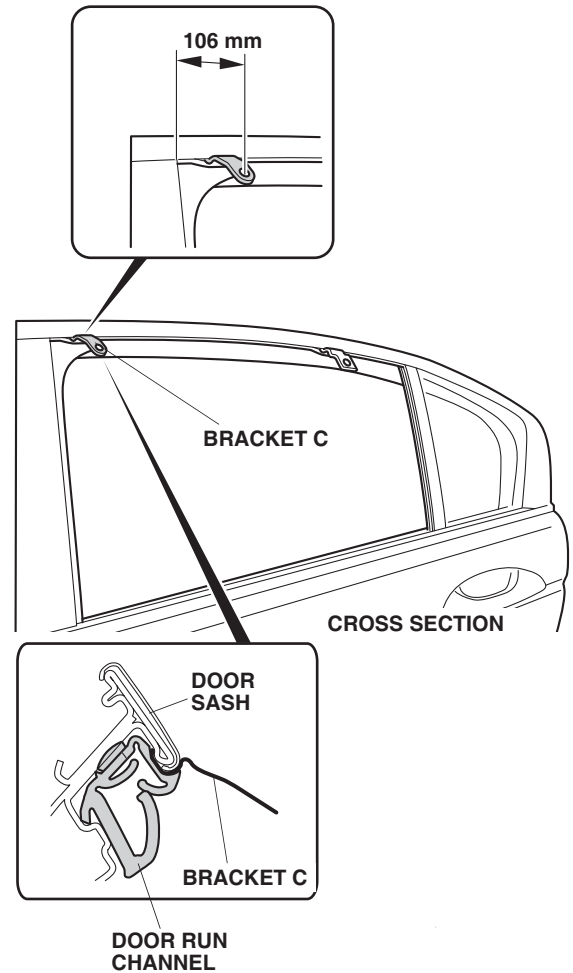

13. Peel back approximately 1-1/2 to 2 inches of adhesive backing from each adhesive tape, and tape the ends to the front surface of the left rear door visor.

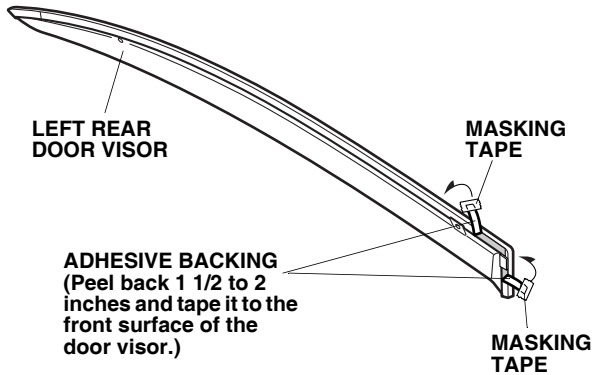

14. Using isopropyl alcohol on a shop towel, clean the door sash where the door visor will attach.



15. Position the door visor on the door sash.

16. Adjust the position of bracket B to align with the door visor then install a clip. Push up on bracket B so the lip of the run channel fits tightly to the bracket. There should be no clearance between the bracket and the door sash.

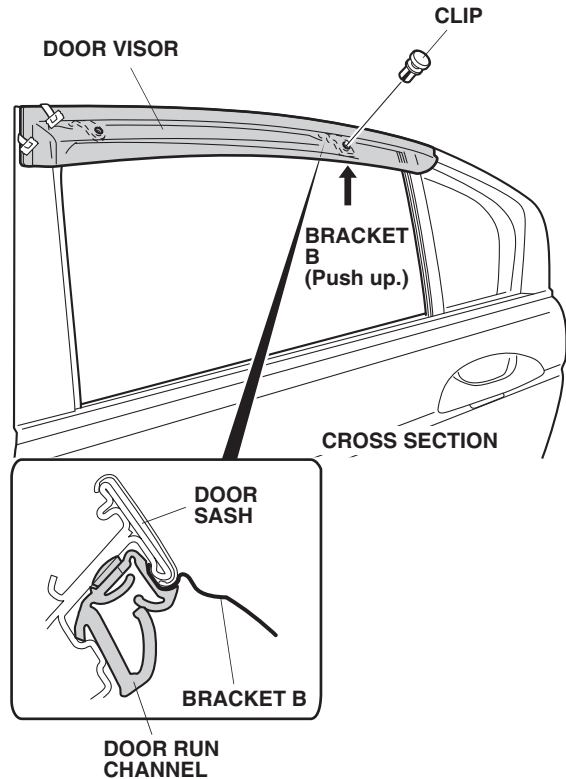

17. Adjust the position of bracket C to align with the door visor, then install a clip. Push up on bracket C so the lip of the run channel fits tightly to the bracket. There should be no clearance between the bracket and the door sash.

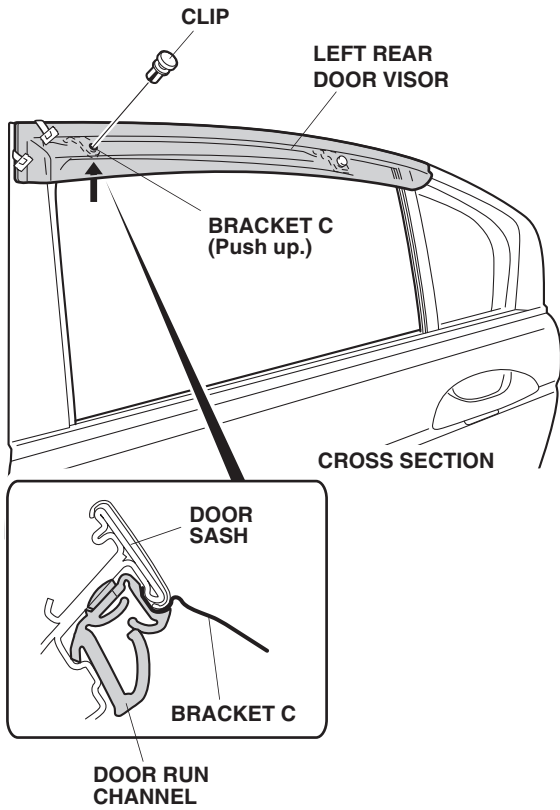

18. Measure the distance between the edge of the door visor and the outside edge of the door sash as shown.

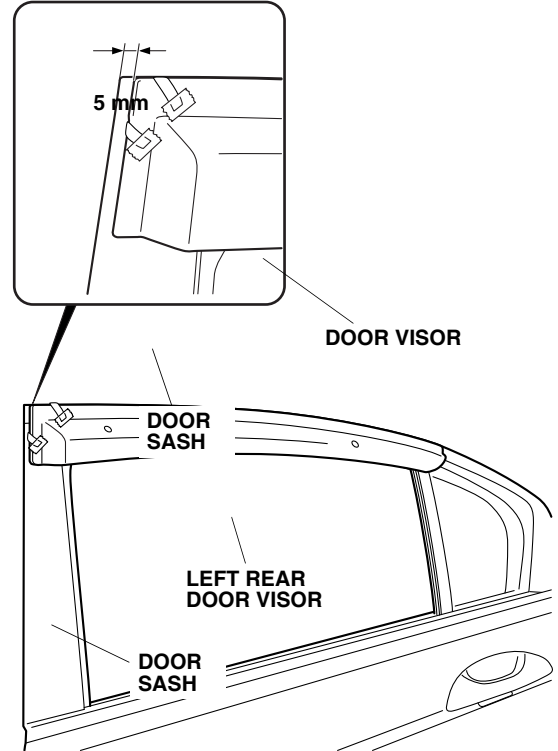

19. Press the left front door visor firmly against the driver's door. Starting from the rear edge of the door visor and working forward, remove the two adhesive backings:
- Attach the adhesive backing on the door visor to the door sash while pushing up the brackets with your finger so that there is no clearance between the bracket and the door sash.
 - Use a soft towel when pressing on the door visor.

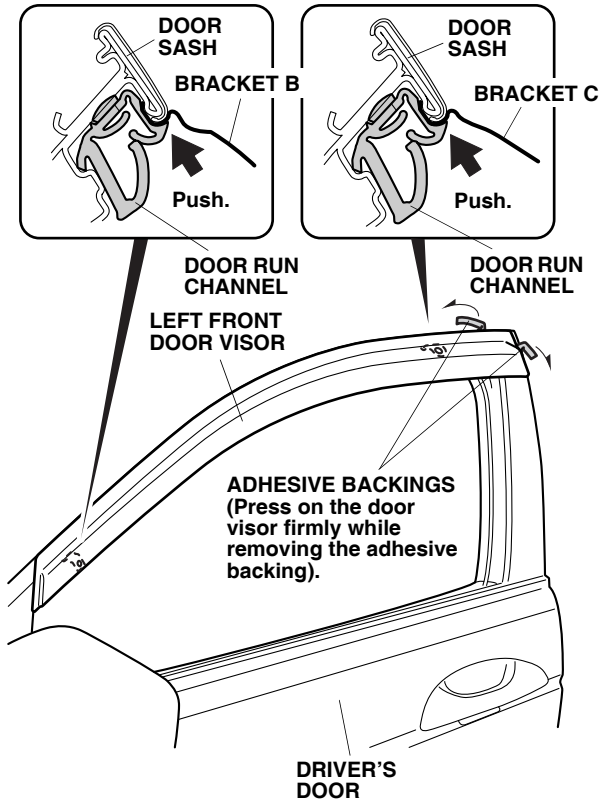

20. Press the left rear door visor firmly against the left rear door. Starting from the rear edge of the door visor and working forward, remove the two adhesive backings:
- Attach the adhesive backing on the door visor to the door sash while pushing up the brackets by your finger so that there is no clearance between the bracket and door sash.
 - Use a soft towel when pressing on the door visor.
21. Repeat steps 1 through 20 to install the door visors on the right side of the vehicle.

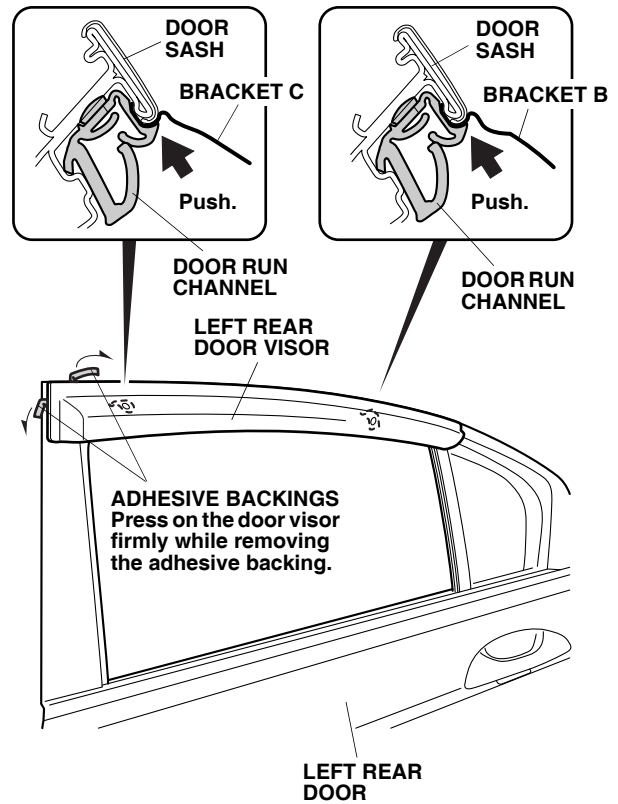

USE AND CARE

Clean the door visors with mild detergent and water. Do not use organic solvents (thinner, benzine, alcohol, etc.) or cleaners containing any abrasive material.