



INSTALLATION INSTRUCTIONS

Accessory

**FOG LIGHT
P/N 08V31-SNA-100B**

Application

**2008 CIVIC
4-DOOR**

Publications No.

All 37730-39125

Issue Date

MARCH 2008

PARTS LIST

Right fog light

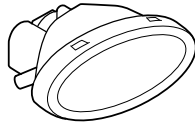

Left fog light

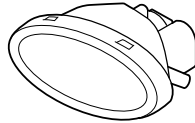

Right bracket A

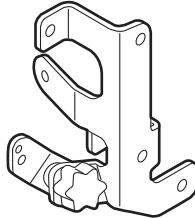

Left bracket A

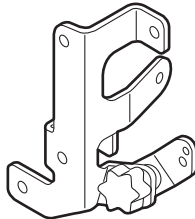

Right bracket B

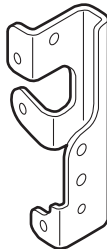

Left bracket B

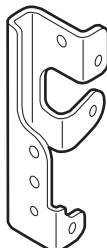

Switch harness

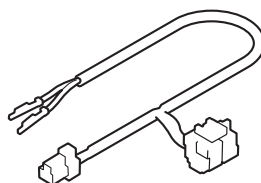

Fog light harness

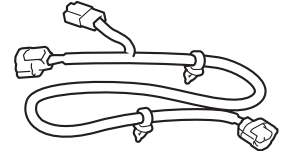

Sub harness

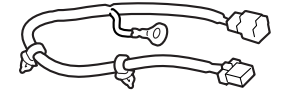

Switch

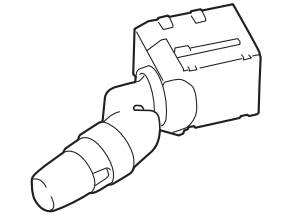

Right trim

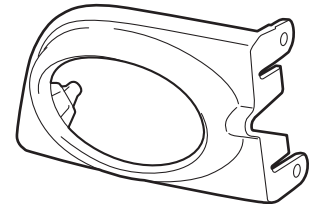

Left trim

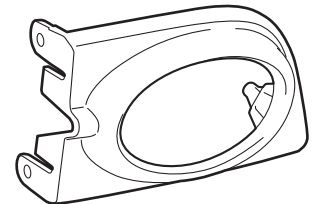

4 Large stepped-screws



6 Wire ties

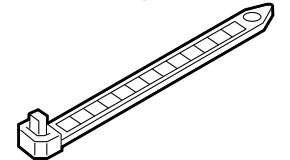

Clip

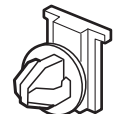

4 Small stepped-screws



2 Washer-screws, 4 x 8 mm



10 Self-tapping screws, 5 x 16 mm



Fuse (20 A)

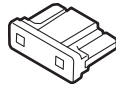

Relay

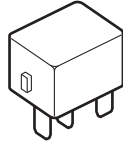

4 Wire ties with clip A

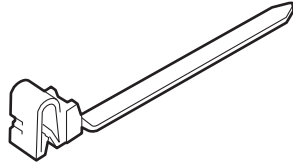

Wire ties with clip B

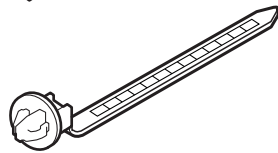

TOOLS AND SUPPLIES REQUIRED

Phillips screwdriver

Flat-tip screwdriver

Ratchet

10 mm Socket

Drill

20 mm Hole saw

Blanket

Pushpin

Utility knife

Gloves

Hacksaw blade

Masking tape

5 mm Hex wrench

Eye protection(face shield, safety goggles, etc.)

File

Illustration of Fog Lights installed on the vehicle

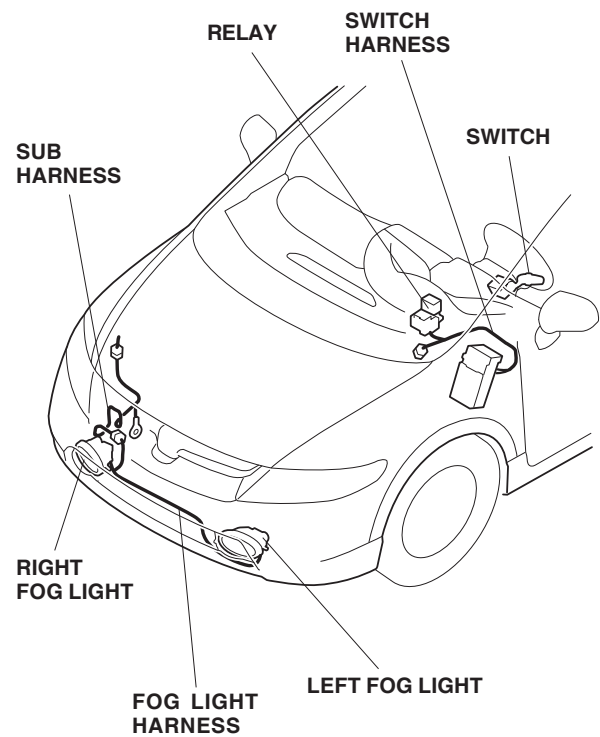

INSTALLATION

Customer Information: The information in this installation instruction is intended for use only by skilled technicians who have the proper tools, equipment, and training to correctly and safely add equipment to your vehicle. These procedures should not be attempted by "do-it-yourselfers."

1. Make sure you have the anti-theft code for the radio, then write down the frequencies for the preset buttons.
2. Disconnect the negative cable from the battery.
3. Remove the front bulkhead cover (two expansion clips, three clips, and move the right and left fender trims inward).

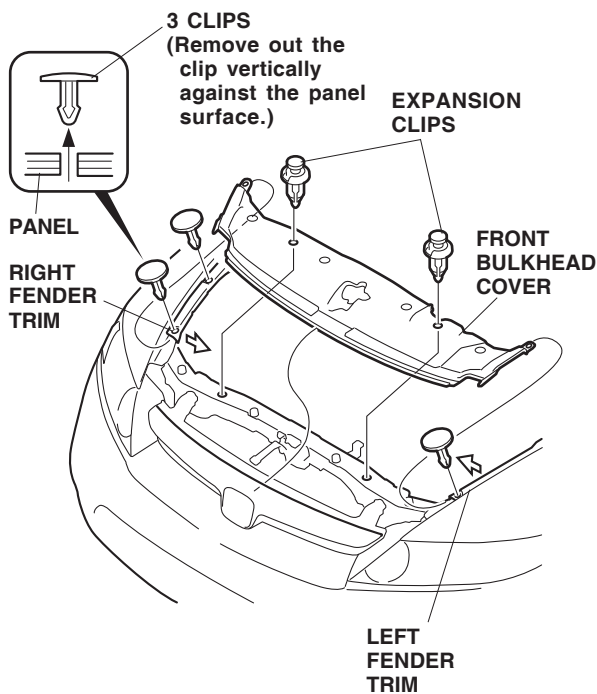

4. With the help of an assistant, remove the front bumper (four long clips, four center clips, two socket bolts, and two self-tapping screws). To prevent damage, set the front bumper on a blanket.

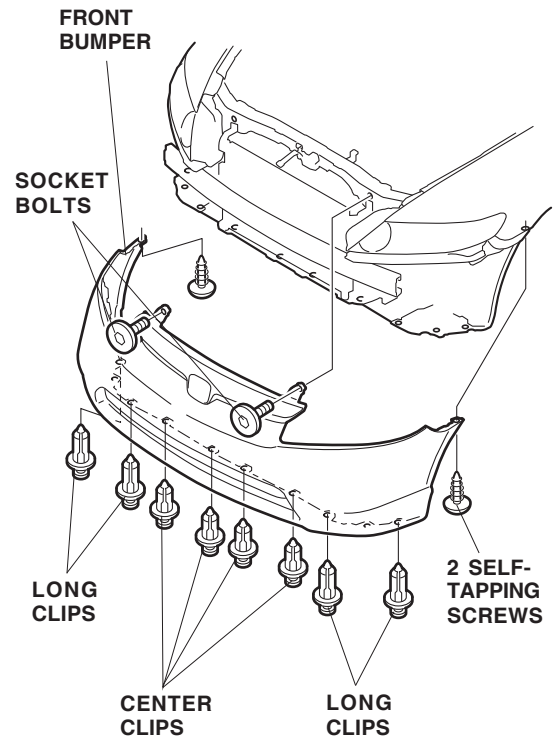

5. Apply masking tape to the front bumper (left side) in the area shown.

