



INSTALLATION INSTRUCTIONS

Accessory
**WOOD-LOOK TRIM KIT
LONG CENTER PANEL
P/N 08Z03-S9V-100C**

Application
2006 PILOT

Publications No.
All 30523
Issue Date
SEP 2005

PARTS LIST

Right lower console trim

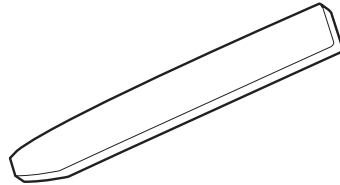

Left lower console trim

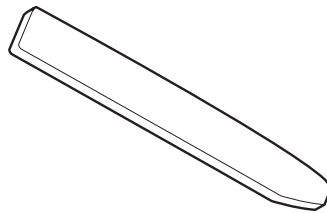

SUPPLIES REQUIRED

Isopropyl alcohol
Shop towel
Masking tape

INSTALLATION

NOTE: This wood trim kit should be installed only if the outside air temperature is 60°F (15°C) or above.

1. Using isopropyl alcohol on a shop towel, thoroughly clean the areas where the wood-grain trims will attach.
2. Attach a strip of masking tape to the end of each outer adhesive backing, and remove 2 to 3 inches of the adhesive backing. Fold the ends back, and tape them to the front of the trims. If necessary, remove and discard the inner adhesive backings.
3. Position the trims on the existing panels. While applying light pressure on the trims, carefully remove the adhesive backings.

4. After installing the trims, use the palm of your hand to hold pressure against the trims for 30 seconds.

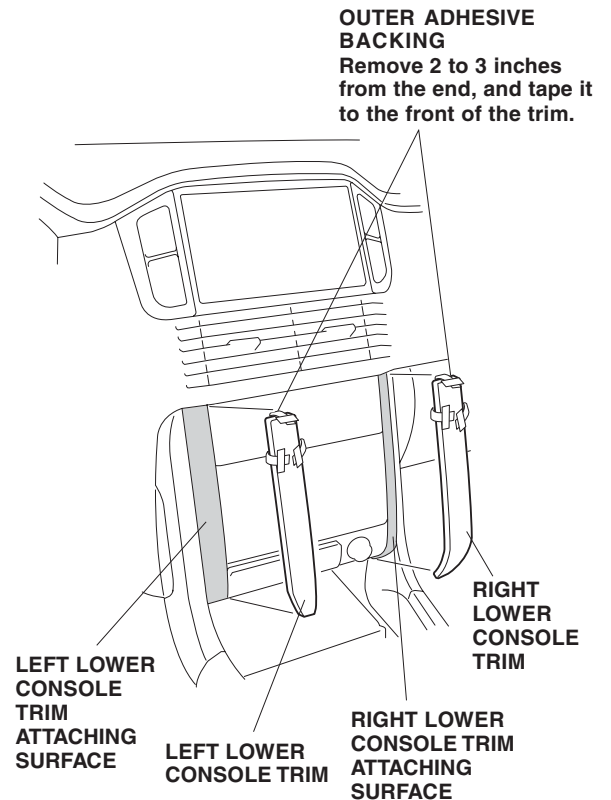

USE AND CARE

Use a sponge or soft cloth dampened with mild detergent and water solution. After cleaning, wipe with a clean, soft cloth. Do not use cleaners or polishers containing abrasive compounds to clean the wood-grain trims as they may damage the surface.